

APPLICATION MANUAL



COMBIVERT F4-F

Charge 40,- Euro

Chapter	Section	Page	Date	Name: Basis	©	KEB Antriebstechnik, 2002 All Rights reserved
1	1	2	18.12.02	KEB COMBIVERT F4-F		

1. Introduction	This chapter shall allow a fast access to the wanted information. It consists of contents, index and search criterion.
2. Summary	Here the inverter and its features as well as the operating conditions and application purpose are described.
3. Hardware	Description of hardware, technical data of the inverter as well as connection of power and control terminals.
4. Operation	The basic operation of the KEB COMBIVERT like password input, parameter and set selection.
5. Parameter	A list of all parameters classified according to parameter groups. The parameter description comprises addresses, value ranges and references with regard to the functions for which they are used.
6. Functions	To make the programming easier all inverter functions and the parameters belonging to it are comprised in this chapter.
7. Start-up	Gives support with regard to the initial start-up and shows possibilities and techniques for the optimization of the drive.
8. Special Operation	Describes special operating modes, like e.g. DC-coupling.
9. Error Assistance	Avoidance of errors, evaluation of error messages and elimination of the causes.
10. Project Planning	Survey of the possible interconnection in existing networks; address and value table for the implementation in own protocols.
11. Networks	Survey of the possible interconnection of the KEB COMBIVERT in existing networks.
12. Applications	In this chapter you find descriptions of some applications which may give new impulses or help to solve own applications.
13. Annex	Everything that didn't fit anywhere else or what we didn't think of earlier.

Chapter 1	Section 1	Page 4	Date 18.12.02	Name: Basis KEB COMBIVERT F4-F	© KEB Antriebstechnik, 2002 All Rights reserved
---------------------	---------------------	------------------	------------------	--	--

1. Introduction
2. Summary
3. Hardware
4. Operation
5. Parameter
6. Functions
7. Start-up
8. Special Operation
9. Error Assistance
10. Project Planning
11. Networks
12. Applications
13. Annex
1.1 General

1.1.1	Table of Contents	7
1.1.2	Preface	7
1.1.3	Record of Changes	9
1.1.4	Technical Terms	13
1.1.5	Characters and Symbols	15

Chapter 1	Section 1	Page 6	Date 18.12.02	Name: Basis KEB COMBIVERT F4-F	© KEB Antriebstechnik, 2002 All Rights reserved
---------------------	---------------------	------------------	------------------	--	--

1. Introduction

1.1 General

1.1.1 Table of Contents

1.	Introduction	1.1.7
1.1	General	1.1.7
1.1.1	Table of Contents	1.1.7
1.1.2	Preface	1.1.13
2.	Overview	2.1.3
2.1	Product Description	2.1.3
2.1.1	Features of KEB COMBIVERT F4-F	2.1.3
2.1.2	Function Principle	2.1.3
2.1.3	Application as directed	2.1.4
2.1.4	Type Code	2.1.5
2.1.5	Validity of Specifications	2.1.6
2.1.6	Unit Sizes 230V-Class	2.1.6
2.1.7	Unit Sizes 400V-Class	2.1.7
3.	Hardware	3.1.3
3.1	Control Units	3.1.3
3.1.1	Survey	3.1.3
3.1.2	Control Cards	3.1.4
3.1.3	Control Terminal Strip X2	3.1.5
3.1.4	Wiring of Digital In-/Outputs	3.1.6
3.1.5	Wiring of Analog In-/Outputs	3.1.6
4.	Operation	4.1.3
4.1	Fundamentals	4.1.3
4.1.1	Parameters, Parameter Groups, Parameter Sets	4.1.3
4.1.2	Selection of a Parameter	4.1.4
4.1.3	Adjustment of Parameter Values	4.1.4
4.1.4	ENTER-Parameter	4.1.4
4.1.5	Non-programmable Parameters	4.1.5
4.1.6	Resetting of Error Messages	4.1.5
4.1.7	Resetting of Peak Values	4.1.5
4.1.8	Acknowledgement of Status Signals	4.1.5
4.2	Password Structure	4.2.3
4.2.1	Password Levels	4.2.3
4.2.2	Passwords	4.2.4
4.2.3	Changing of Password Level	4.2.4
4.3	CP-Parameter	4.3.3
4.3.1	Operation in CP-Mode	4.3.3
4.3.2	Factory Setting	4.3.3
4.3.3	Description of CP-Parameter	4.3.5

	4.4	Drive-Mode	4.4.3
	4.4.1	Adjustment Possibilities	4.4.3
	4.4.2	Display and Keyboard	4.4.3
	4.4.3	Setpoint Display /Setpoint Input	4.4.3
	4.4.4	Rotation Setting	4.4.4
	4.4.5	Start / Stop / Run	4.4.4
	4.4.6	Leaving the Drive-Mode	4.4.5
5.	Parameter		5.1.3
	5.1	Parameter	5.1.3
	5.1.1	Parameter Groups	5.1.3
	5.1.2	Parameterlisting F4-F	5.1.5
6.	Functional Description		6.1.3
	6.1	Operating and Unit Datas	6.1.3
	6.1.1	Summary of ru-Parameter	6.1.3
	6.1.2	Summary of In-Parameter	6.1.3
	6.1.3	Explanation to Parameter Description	6.1.4
	6.1.4	Description of ru-Parameter	6.1.5
	6.1.5	Description of In-Parameter	6.1.16
	6.2	Analog In- and Outputs	6.2.3
	6.2.1	Brief Description	6.2.3
	6.2.2	Analog Inputs	6.2.3
	6.2.3	Measured value hysteresis	6.2.6
	6.2.4	Interference Suppressor Filter Analog Inputs (An.1)	6.2.6
	6.2.5	Gain of Input Characteristic (An.3...5, An.9...11)	6.2.6
	6.2.6	Zero Point Hysteresis of Analog Inputs (An.2 / An.8)	6.2.9
	6.2.7	Analog Outputs	6.2.10
	6.2.8	Gain of Output Characteristic (An.15/16, An.19/20)	6.2.11
	6.2.9	Used Parameters	6.2.14
	6.3	Digital In- and Outputs	6.3.3
	6.3.1	Brief Description Digital Inputs	6.3.3
	6.3.2	Input Signals PNP / NPN (di.1)	6.3.3
	6.3.3	Terminal Status (ru.14)	6.3.4
	6.3.4	Digital Inputs set by Software (di.15, di.16)	6.3.4
	6.3.5	Digital Filter (di.0)	6.3.5
	6.3.6	Inverting of Inputs (di.2)	6.3.5
	6.3.7	Strobe-Dependent Inputs (di.17...di.19)	6.3.6
	6.3.8	Function Assignment (di.3...di.12)	6.3.7
	6.3.9	Input Status (ru.16)	6.3.8
	6.3.10	Brief Description - Digital Outputs	6.3.9
	6.3.11	Output Signals	6.3.10
	6.3.12	Switching Conditions (do.1...do.8)	6.3.10
	6.3.13	Output Filter Unit (do.26...do.31)	6.3.12
	6.3.14	Inverting of Switching Conditions do.17...do.24	6.3.14
	6.3.15	Selection of Switching Conditions (do.9...do.16)	6.3.14
	6.3.16	Logic Operation of Switching Conditions (do.25)	6.3.14

	6.3.17	Inverting of Outputs (do.0)	6.3.15
	6.3.18	Output Terminal Status (ru.15)	6.3.15
	6.3.19	Used Parameters	6.3.16
6.4	Set Value and Ramp Adjustment	6.4.3	
	6.4.1	Brief Description	6.4.3
	6.4.2	AUX-Function, Setpoint and Rotation Selection	6.4.4
	6.4.3	Setpoint Limits	6.4.7
	6.4.4	Setpoint Calculation	6.4.8
	6.4.5	Ramp Generator	6.4.10
	6.4.6	Used Parameters	6.4.13
6.5	Motor Data and Controller Adjustment	6.5.3	
	6.5.1	Motor Name Plate	6.5.3
	6.5.2	Motor Data from Name Plate (dr.0...dr.4, dr.12)	6.5.3
	6.5.3	Motor Adaption (Fr.10)	6.5.4
	6.5.4	Controlled Operation	6.5.5
	6.5.5	Modulation Rate (dS.12) and Overmodulation (dS.14)	6.5.8
	6.5.6	Operating Frequency (dS.13)	6.5.8
	6.5.7	Controller Structure	6.5.9
	6.5.8	Current Control (Torque Control)	6.5.10
	6.5.9	Speed Control	6.5.10
	6.5.10	Torque Limitation	6.5.11
	6.5.11	Flux Lowering Calculation	6.5.12
	6.5.12	Flux Control	6.5.13
	6.5.13	Max. Voltage Control	6.5.13
	6.5.14	Motor Parameter Adaption	6.5.14
	6.5.15	Torque Control	6.5.19
	6.5.16	Inertia Torque (dr.56)	6.5.21
	6.5.17	Used Parameters	6.5.21
6.6	Keep on Running Functions	6.6.3	
	6.6.1	Thermal Motor Protection	6.6.3
	6.6.2	Electronic Motor Protection	6.6.3
	6.6.3	Thermal Inverter Protection	6.6.5
	6.6.4	Power-Off Function	6.6.5
	6.6.5	External Error Control Procedure	6.6.6
	6.6.6	Watchdog-Time (Pn.23)	6.6.6
	6.6.7	Limit Switch (Pn.24)	6.6.6
	6.6.8	Braking torque /Emergency stop, Emergency-Stop-Ramp (Pn.60, Pn.63)	6.6.7
	6.6.9	Automatic Restart and Speed Search	6.6.7
	6.6.10	Used Parameters	6.6.8
6.7	Parameter Sets	6.7.3	
	6.7.1	Non-programmable Parameters	6.7.3
	6.7.2	Copying of Parameter Sets (Fr.0, Fr.1, Fr.9)	6.7.3
	6.7.3	Selection of Parameter Sets	6.7.4
	6.7.4	Locking of Parameter Sets	6.7.6

	6.7.5	Parameter Set ON and OFF Delay (Fr.5, Fr.6).....	6.7.7
	6.7.6	Used Parameters	6.7.7
6.8		Special Functions	6.8.3
	6.8.1	Brake Control	6.8.3
	6.8.2	Adjustment Assistant	6.8.7
	6.8.3	AUX-Function (An.13)	6.8.9
	6.8.4	Motorpotentiometer Function	6.8.11
	6.8.5	Temperature Control	6.8.14
6.9		Encoder Interface	6.9.3
	6.9.1	Designs	6.9.3
	6.9.2	Encoder Interface Channel 1 (X4) Increment encoder	6.9.4
	6.9.3	Encoder Interface Channel 1 (X4) Resolver	6.9.6
	6.9.4	Encoder Interface Channel 1 (X4) Hiperface	6.9.6
	6.9.5	Encoder Interface Channel 2 (X5)	6.9.8
	6.9.6	Selection of Encoder	6.9.10
	6.9.7	Basic Setting	6.9.12
	6.9.8	Power Supply of Encoder	6.9.13
	6.9.9	Used Parameters	6.9.14
6.10		Synchronous Control	6.10.3
	6.10.1	Gear Ratio	6.10.4
	6.10.2	Position Controller	6.10.5
	6.10.3	Calculation of the Set Position	6.10.6
	6.10.4	Synchronization	6.10.7
	6.10.5	Register function	6.10.10
	6.10.6	Connection Accessories for Master- Slave Operation	6.10.12
	6.10.7	Used Parameters	6.10.13
6.11		Positioning Module	6.11.3
	6.11.1	Activating Positioning Module (Pc.0, Pd.0)	6.11.3
	6.11.2	Selection of Endocer Input for the Position Feedback (Pc.16)	6.11.8
	6.11.3	Gear Factor for Encoder Input 2 (Pc.17)	6.11.9
	6.11.4	Display Mode of Position Values (Pc.1)	6.11.6
	6.11.5	Calculation of the position profile and Speed Precontrol ...	6.11.7
	6.11.6	Position Controller (Pd.2)	6.11.10
	6.11.7	Software Limit Switch (Pc.4...Pc.9)	6.11.10
	6.11.8	Determining of the Set-position	6.11.11
	6.11.9	Variation of the Set-position	6.11.13
	6.11.10	Determining of the Actual-position	6.11.16
	6.11.11	Switching conditions for Posi.....	6.11.20
	6.11.12	Adjustment of Position Controller and Drive Profile	6.11.22
	6.11.13	Check List	6.11.24
	6.11.14	Programming Examples	6.11.25
	6.11.15	Used Parameters	6.11.32
6.12		CP-Parameter Definition	6.12.3
	6.12.1	Survey	6.12.3

	6.12.2	Assignment of CP-Parameter	6.12.4
	6.12.3	Start Parameter (ud.2, ud.3)	6.12.4
	6.12.4	Example	6.12.5
	6.12.5	Used Parameters	6.12.5
7.		Start-up	7.1.3
	7.1	Preparatory Measures	7.1.3
	7.1.1	After unpacking the Goods	7.1.3
	7.1.2	Installation and Connection	7.1.3
	7.1.3	Checklist prior to Start-up	7.1.4
	7.2	Initial Start-up	7.2.3
	7.2.1	Start-up (controlled)	7.2.3
	7.2.2	Start-up (closed-loop)	7.2.4
8.		Special Operation	8.1.2
9.		Error Assistance	9.1.3
	9.1	Troubleshooting	9.1.3
	9.1.1	General	9.1.3
	9.1.2	Error Messages and their Cause	9.1.3
10.		Project Planning	10.1.3
	10.1	General Design	10.1.3
	10.1.1	Control Cabinet Design Calculation	10.1.3
	10.1.2	Design of Braking Resistors	10.1.4
11.		Networks	11.1.3
	11.1	Network Components	11.1.3
	11.1.1	Available Hardware	11.1.3
	11.1.2	RS232-Cable PC/Inverter	11.1.3
	11.1.3	Interface- and Bus-Operator	11.1.4
	11.1.4	Optical Fibre BUS	11.1.5
	11.1.5	InterBus Loop-Operator	11.1.9
	11.2.	Bus-/DRIVECOM-Parameter	11.2.3
	11.2.1	Adjustment of Inverter Address (ud.6)	11.2.3
	11.2.2	Baud Rate (ud.7)	11.2.3
	11.2.3	Used parameter	11.2.4
12.		Applications	12.1.2
13.		Annex	13.1.3
	13.1	Search and Find	13.1.3
	13.1.1	Index	13.1.3
	13.1.2	Term Definition	13.1.9
	13.1.3	KEB- Worldwide	13.1.11
	13.1.4	Domestic Representations	13.1.12
	13.1.5	Notes	13.1.13

Chapter	Section	Page	Date	Name: Basis	©	KEB Antriebstechnik, 2002 All Rights reserved
1	1	12	18.12.02	KEB COMBIVERT F4-F		

1.1.2 Preface

Who shall read all this?

Everybody who is entrusted with the development and construction of applications. He who knows the extensive programming possibilities of the COMBIVERT, can save external controls and expensive cabling already in the planning stage of a machine simply by using the unit as active control element. This manual is **not** a replacement of the documentation accompanying the unit, it serves only as completion.

1000 and one application...

and if possible with one unit. Who does not know this demand from purchasing departments, production or service. We have taken this request very seriously and developed a series with open programming, which can be adapted to the different applications with PC, chipcard or manually.

Nobody can handle this...

some sceptics may say. But we have found a solution to this too. Once the development stage of a machine is completed only a few adjustment possibilities are needed on the inverter and in some cases even none at all. So why should all parameters still be visible? Said and done, by defining an own menu only selected parameters are visible. This makes the handling much easier, simplifies the user documentation and improves the safety of operation against unauthorized access (see picture 1.1.2).

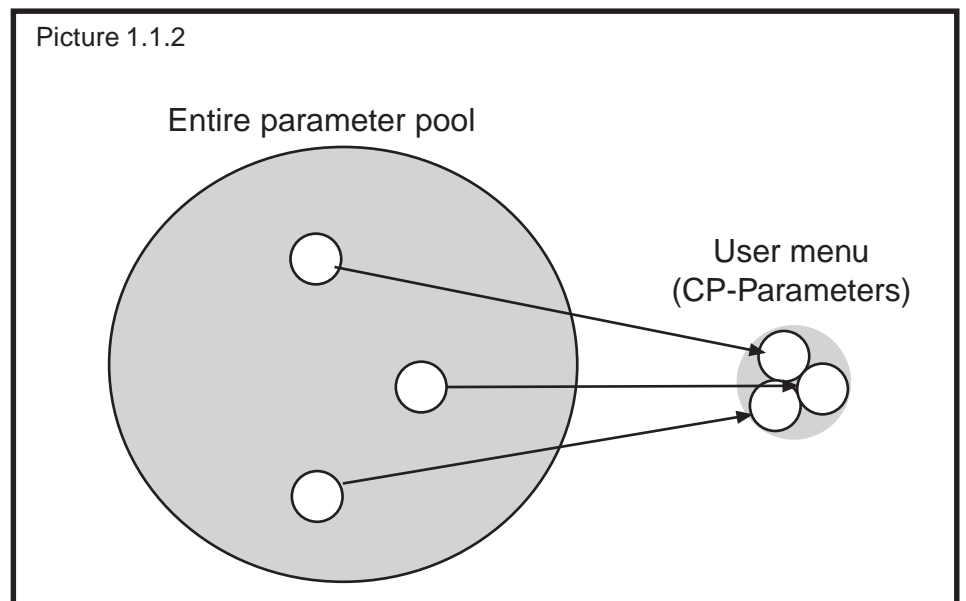

Chapter 1	Section 1	Page 14	Date 18.12.02	Name: Basis KEB COMBIVERT F4-F	© KEB Antriebstechnik, 2002 All Rights reserved
---------------------	---------------------	-------------------	------------------	--	--

- 1. Introduction
- 2. Summary**
- 3. Hardware
- 4. Operation
- 5. Parameter
- 6. Functions
- 7. Start-up
- 8. Special Operation
- 9. Error Assistance
- 10. Project Planning
- 11. Networks
- 12. Applications
- 13. Annex

2.1 Product Description

- 2.1.1 Features of KEB COMBIVERT F4-F 3
- 2.1.2 Function Principle 4
- 2.1.3 Application as directed 4
- 2.1.4 Type Code 5
- 2.1.5 Validity of Specifications 6
- 2.1.6 Unit Sizes 230V-Class 6
- 2.1.7 Unit Sizes 400V-Class 7

Chapter	Section	Page	Date	Name: Basis	©	KEB Antriebstechnik, 2002 All rights reserved
2	1	2	15.10.02	KEB COMBIVERT F4-F		

2. Overview

2.1 Product Description

2.1.1 Features of KEB COMBIVERT F4-F

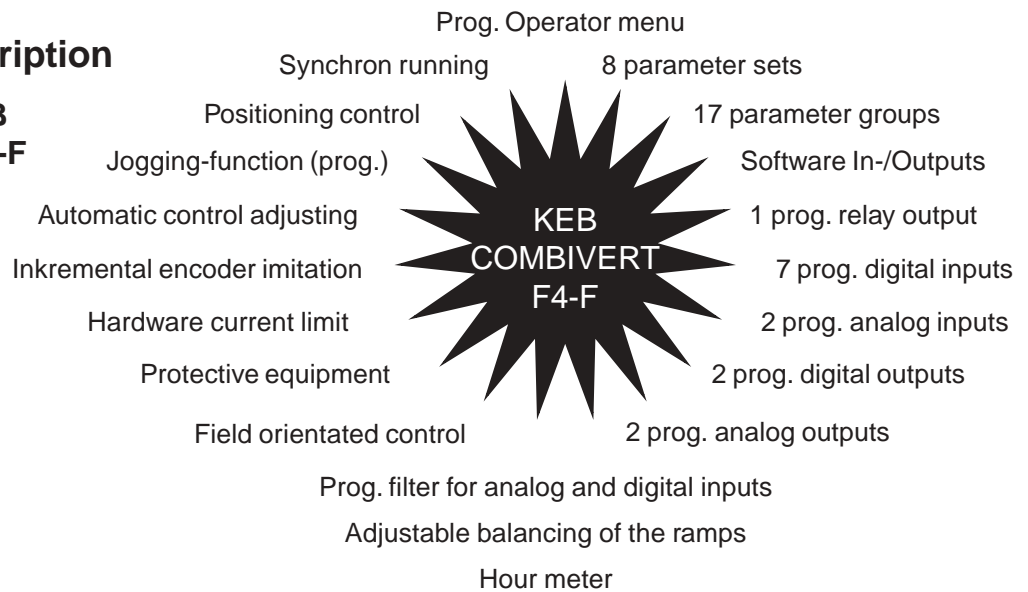

2.1.2 Function Principle

The power circuit of a frequency inverter consists basically of a mains rectifier, the DC-link and an inverter at the output. The mains rectifier consists of an single or three-phase bridge connection, the single-phase design is restricted to small powers. It converts the AC-voltage of the mains into a DC-voltage, which is smoothed by the DC-link capacitor, thus in the ideal case (inverter unloaded) the DC-link is charged with a voltage of $U_{ZK} = \sqrt{2} \cdot U_N$.

Since during the charging of the DC-link capacitor very high currents flow for a short time which would lead to the tripping of the input fuses or even to the destruction of the mains rectifier, the charging current must be limited to a permissible level. This is achieved by using an inrush current limiting resistor in series to the capacitor. After the charging of the capacitor is completed the limiting resistor is bridged, for example, by a relay and is therefore only active at the switch-on of the inverter.

As the smoothing of the DC-link voltage requires a large capacity, the capacitor still has a high voltage for some time after the disconnection of the inverter from the mains.

The actual task of the frequency inverter, to produce an output voltage variable in frequency and amplitude for the regulation/control of the three-phase AC motor, is taken over by the converter at the output. It makes available a 3-phase output voltage according to the principle of the pulse-width modulation, which generates a sinusoidal current at the three-phase asynchronous motor

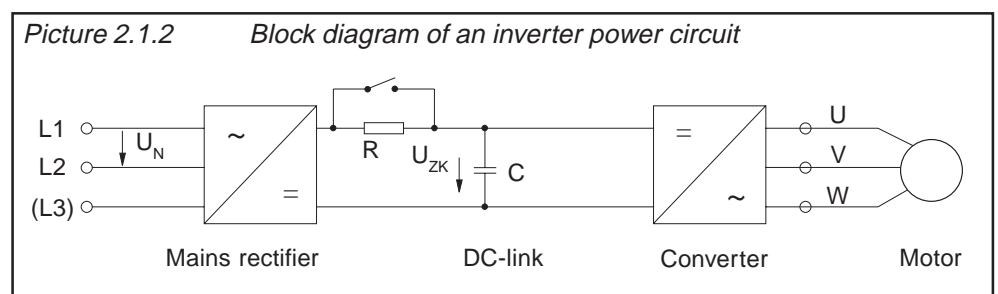

2.1.3 Application as directed



The KEB COMBIVERT is a frequency inverter with DC-voltage link. It works according to the principle of the pulse-width modulation and serves exclusively for the stepless speed regulation/control of three-phase AC motors.

The unit has been developed subject to the relevant safety standards and is manufactured with the highest demands on quality. Condition for an unobjectionable operation is the function-conform configuring of the drive and correct transport and storage as well as careful installation and connection.

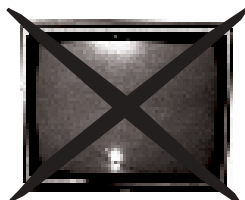

The operation of other electric consumers is prohibited and can lead to the destruction of the units as well as consequential damages as a result from it.

2.1.4 Type Code

Part Number

15.F4.F1G-3440

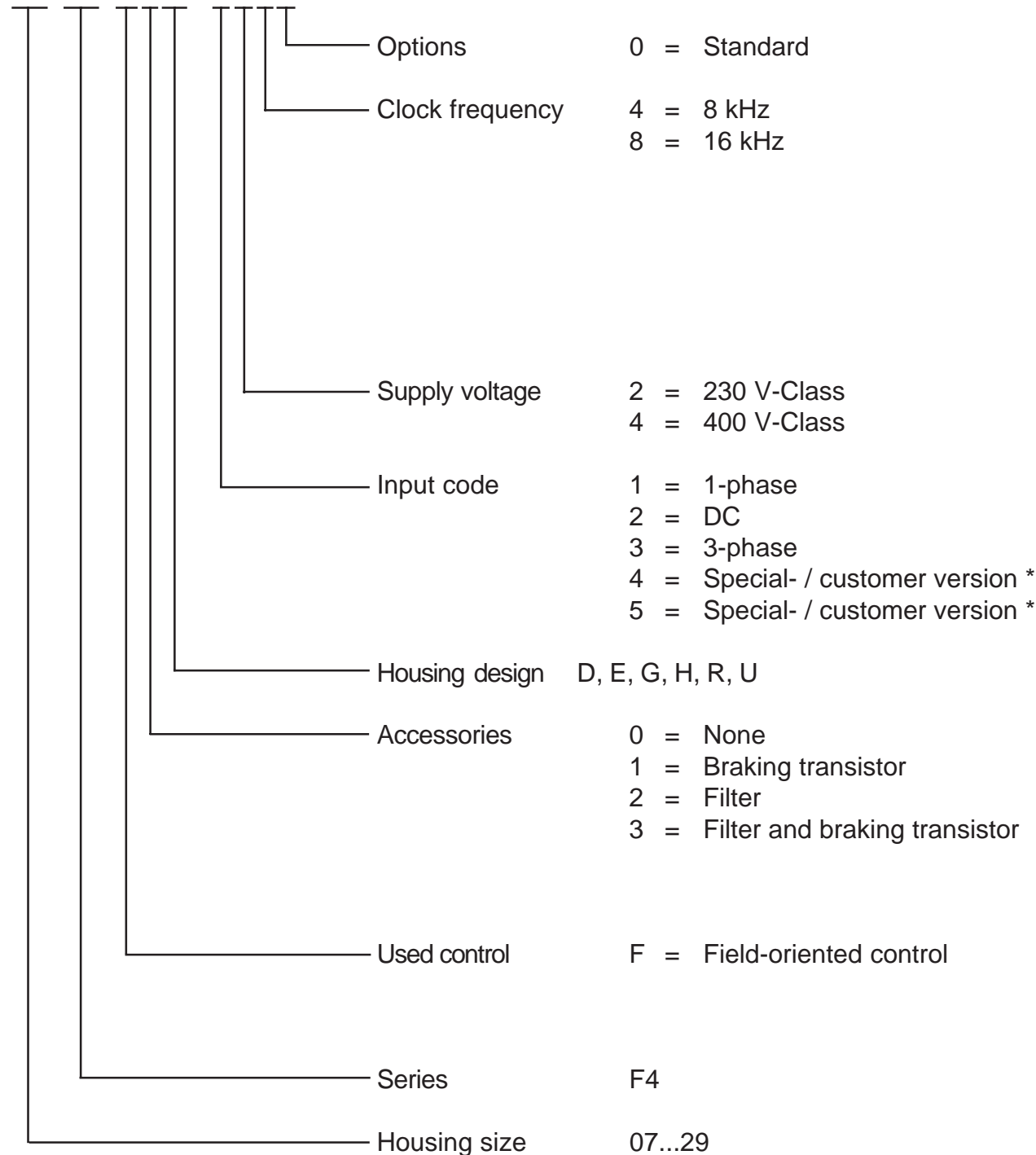

*) For customer or special versions the last 4 digits are different from the above type code.

2.1.5 Validity of Specifications

! The following technical specifications refer to 2-/4-pole standard motors. In case of different pole numbers the frequency inverter must be dimensioned for the rated motor current. With regard to special or medium frequency motors, please contact KEB.

Site altitude max. 2000 m. For altitudes of 1000 m or more above N.N. a power reduction of 1 % per 100m must be taken into account.

2.1.6 Unit Sizes 230V-Class

Inverter Size		07		12		13	14	15	16
Output nominal power	[kVA]	1,6		6,6		8,3	11	17	23
Max. rated motor power	[kW]	0,75		4		5,5	7,5	11	15
Output nominal current	[A]	4		16,5		24	33	48	66
Max. short-time current	[A]	7,2		24,8		36,5	49,5	72	99
OC-tripping current	[A]	8,8		29,7		43	59	88	119
Nominal input current	[A]	8	4,4	33	18,1	26,5	36	53	73
Housing size		D	D	E	E	G	G	H	H
Rated operating frequency	[kHz]	16		8		16	16	16	16
Max. operating frequency	[kHz]	16		8		16	16	16	16
Power loss at nominal operating	[W]	65		210		220	280	430	550
Stall current at 8kHz	[A]	-	-	16,5		19	-	-	-
Stall current at 16kHz	[A]	-	-	-	-	8,6	-	-	-
Max. heat sink temperature T_{OH}	[°C]	85		73		90	90	90	90
Max. permissible mains fuse (inert)	[A]	20	10	35	25	35	50	80	80
Line cross section	[mm ²]	2,5	1,5	6	4	6	10	25	25
Min. braking resistor ¹⁾	[Ω]	56		21		16	13	5,6	5,6
Typ. braking resistor ¹⁾	[Ω]	100		28		22	16	13,6	8,8
Max. braking current	[A]	7		19		29	29	70	70
Tightening torque for terminals	[Nm]	0,5		0,5		1,2			
Mains voltage	[V]	305...500 +/- 0 (400V Nominal voltage)							
Phases		1	3	1	3	3	3	3	3
Mains frequency	[Hz]	50 / 60 +/- 2							
Output voltage	[V]	3 x 0...U Mains							
Output frequency	[Hz]	see control board							
Shielded motor line length	[m]	30	30	100					
Storage temperature	[°C]	-25...70 °C							
Operating temperature	[°C]	-10...45 °C							
Model / protective system		IP20							
Relative humidity		max. 95% without condensation							
Tested in accordance with...		EN 61800-3							
Climatic category		3K3 in accordance with EN 50178							

1) The statement counts only for frequency inverters with internal braking transistor (see „2.1.4 Type Code“).

2.1.7 Unit Sizes 400V-Class (10-17)

Inverter Size		10	12	13		14		15	16		17		
Output nominal power	[kVA]	4	6,6	8,3		11		17	23		29		
Max. rated motor power	[kW]	2,2	4	5,5		7,5		11	15		18,5		
Output nominal current	[A]	5,8	9,5	12		16,5		24	33		42		
Max. short-time current	[A]	10,4	17,1	21,6	18	29,7	24,8	36	49,5		63		
OC-tripping current	[A]	12,7	20,9	26,4	21,6	36,3	29,7	43,2	59,4		75,6		
Nominal input current	[A]	6,4	10,5	13,2		18,1		26,5	36,5		46		
Housing size		D	E	E	G	E	G	G	H	G	H	H	R
Rated operating frequency	[kHz]	8	16	16		8	16	8	16	8	16	8	16
Max. operating frequency	[kHz]	16	16	16		16	16	16	16	16	16	16	16
Power loss at nominal operating	[W]	130	180	240	200	240	260	290	360	310	490	470	700
Stall current at 8kHz	[A]	6,4	9,5	12	19	16,5	19	19	25	21,5	33	30	42
Stall current at 16kHz	[A]	-	9,5	12	12	-	12	8,5	15	9,7	20	13,5	30
Max. heat sink temperature T_{OH}	[°C]	79	73	73	90	73	90	90		90		90	79
Max. permissible mains fuse (inert) ¹⁾	[A]	10	20	20		25		35	50		63		
Line cross section	[mm ²]	1,5	2,5	2,5		4		6	10		16		
Min. braking resistor ²⁾	[Ω]	160	50	50	39	50	39		22	25	22	22	9
Typ. braking resistor ²⁾	[Ω]	270	150	100		82		56		39		28	
Max. braking current	[A]	5	15	15	21	15	21	21	37	30	37	37	88
Tightening torque for terminals	[Nm]	0,5	0,5	0,5	1,2	0,5	1,2	1,2	2,5	1,2	2,5	2,5	
Mains voltage ³⁾	[V]	305...500 +/-0 (400V Nominal voltage) ¹⁾											
Phases		3											
Mains frequency	[Hz]	50 / 60 +/- 2											
Output voltage	[V]	3 x 0...U Mains											
Output frequency	[Hz]	see control board											
Shielded motor line length	[m]	100											
Storage temperature	[°C]	-25...70 °C											
Operating temperature	[°C]	-10...45 °C											
Model / protective system		IP20											
Relative humidity		max. 95% without condensation											
Tested in accordance with...		EN 61800-3											
Climatic category		3K3 in accordance with EN 50178											

- 1) From housing size M fuses of Type Ferra Z 6,6 URD xxx must be used.
- 2) This data is only valid for units with internal brake transistor (see „2.1.4 Type Code“).
- 3) At mains voltage $\geq 460V$ multiply the nominal current with factor 0,86.
- 4) These units can be used with one or more braking modules. For more informations contact KEB.

Unit Sizes 400V-Class (18-24)

Inverter Size	18		19		20	21	22	
Output nominal power [kVA]	35		42		52	62	80	
Max. rated motor power [kW]	22		30		37	45	55	
Output nominal current [A]	50		60		75	90	115	
Max. short-time current ¹⁾ [A]	75		90		112,5	135	172,5	
OC-tripping current [A]	90		108		135	162	207	
Nominal input current [A]	55		66		83	100	127	
Housing size	H	R	H	R	R	R	R	R
Rated operating frequency ²⁾ [kHz]	8	16	4	8	8	4/8	4	8
Max. operating frequency [kHz]	16	16	16	16	16	16	4	8
Power loss at nominal operating [W]	610	850	540	750	900	1100	1200	1500
Stall current at 8kHz [A]	45	50	-	60	75	90	-	115
Stall current at 16kHz [A]	20,3	40	-	27	33,7	40,5	-	-
Max. heat sink temperature T _{OH} [°C]	90							
Max. permissible mains fuse (inert) ²⁾ [A]	80		80		100	160	160	
Line cross section [mm ²]	25		25		35	50	50	
Min. braking resistor ³⁾ [Ω]	13	9	13	9	9	9	8	
Typ. braking resistor ³⁾ [Ω]	20		15		12	10	8,6	
Max. braking current [A]	63	88	63	88	88	88	88	
Overload curve (Page 38)	1							
Tightening torque for terminals [Nm]	2,5	6	2,5	6				
Wiring diagram (Page 18/19)	4	3	4	3	3	3	3	
Mains voltage ⁴⁾ [V]	305...500 +/-0 (400V Nominal voltage)							
Phases	3							
Mains frequency [Hz]	50 / 60 +/- 2							
Output voltage [V]	3 x 0...U Mains							
Output frequency [Hz]	see control board							
Shielded motor line length [m]	100	100		50	50	50		
Storage temperature [°C]	-25...70 °C							
Operating temperature [°C]	-10...45 °C							
Model / protective system	IP20							
Relative humidity	max. 95% without condensation							
EMC tested in accordance with...	EN 61800-3							
Climatic category	3K3 in accordance with EN 50178							
Mains choke (s. page 27) Nr.	28		29		30	31	32	
Motor choke (s. page 33) Nr.	28		29		30	31	32	
HF-Filter assembly kit (s. page 29) Nr.	17	20	17	20	20	22	22	
Sine filter (s. page 35) Nr.	8		9		10	11	12	
Sine filter plus (s. page 37) Nr.	-	-	-	-	-	-	-	-

- 1) From housing size M fuses of Type Ferra Z 6,6 URD xxx must be used.
- 2) This data is only valid for units with internal brake transistor (see „2.1.4 Type Code“).
- 3) At mains voltage $\geq 460V$ multiply the nominal current with factor 0,86.
- 4) These units can be used with one or more braking modules. For more informations contact KEB.

23		24		25	26	27
104		125		145	173	208
75		90		110	132	160
150		180		210	250	300
225		270		262,5	312,5	375
270		324		315	375	450
165		198		231	275	330
R	U	U		U	U	U
2	8	4	8	4	4	2
2	16	4	8	4	4	2
1300	1900	2000	2400	2300	2800	3100
-	150	-	180	-	-	-
-	-	-	-	-	-	-
90						
200		315		315	400	450
95		95		95	120	150
6	5	4		2,7	2,7	2,7
6,7		5		4,3	3,8	3,3
133	160	200		200	200	200
1				2		
15				25		
3	3	3		3	3	3
305...500 +/-0 (400V Nominal voltage)						
3						
50 / 60 +/- 2						
3 x 0...U Mains						
see control board						
50						
-25...70 °C						
-10...45 °C						
IP20						
max. 95% without condensation						
EN 61800-3						
3K3 in accordance with EN 50178						
33		34		35	36	37
33		34		35	36	37
23		24		24	26	26
-	33	34		35	36	37
-	-	-	-	-	-	-

Chapter	Section	Page	Date	Name: Basis	©	KEB Antriebstechnik, 2002 All rights reserved
2	1	10	15.10.02	KEB COMBIVERT F4-F		

1. Introduction

2. Summary

3. Hardware

4. Operation

5. Parameter

6. Functions

7. Start-up

8. Special Operation

9. Error Assistance

10. Project Planning

11. Networks

12. Applications

13. Annex

3.1 Control Units

3.1.1	Survey	3
3.1.2	Control Cards	4
3.1.3	Control Terminal Strip X2	5
3.1.4	Wiring of Digital Inputs	6
3.1.5	Wiring of Analog Inputs	6

Chapter 3	Section 1	Page 2	Date 18.12.02	Name: Basis KEB COMBIVERT F4-F	© KEB Antriebstechnik, 2002 All Rights reserved
---------------------	---------------------	------------------	------------------	--	--

3. Hardware

3.1 Control Units

3.1.1 Survey

Housing size D - E

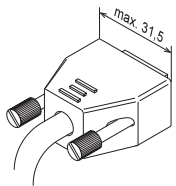

Observe the maximal width of connectors for X4 and X5.

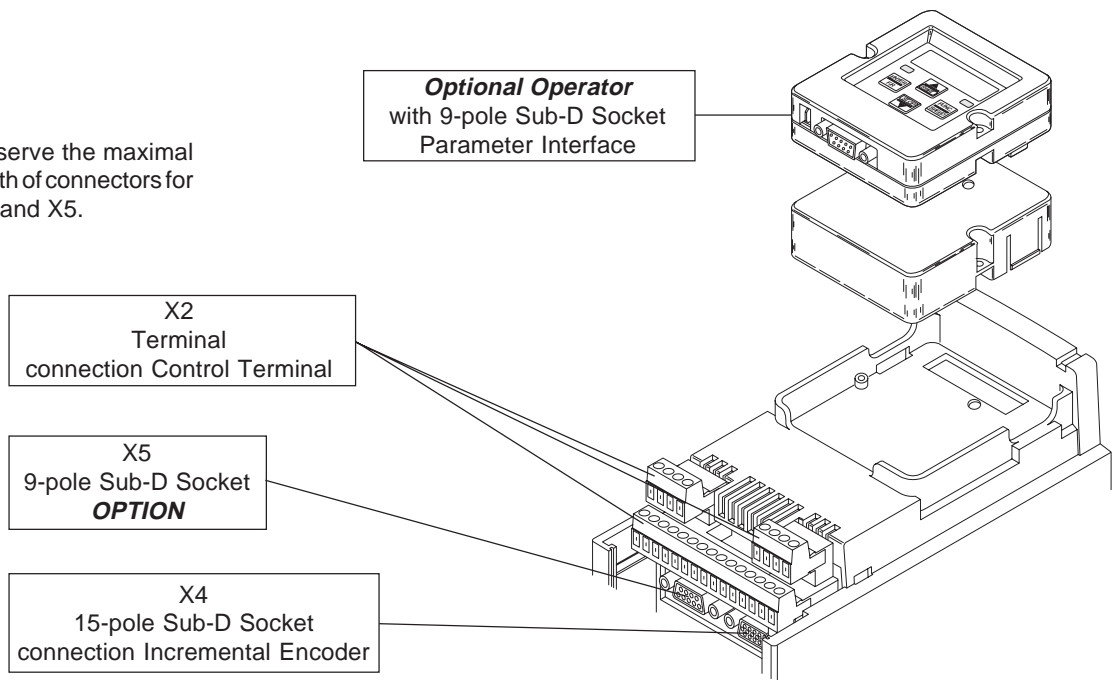

Housing size G - L

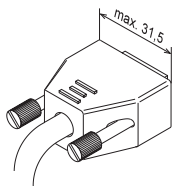

Observe the maximal width of connectors for X4 and X5.

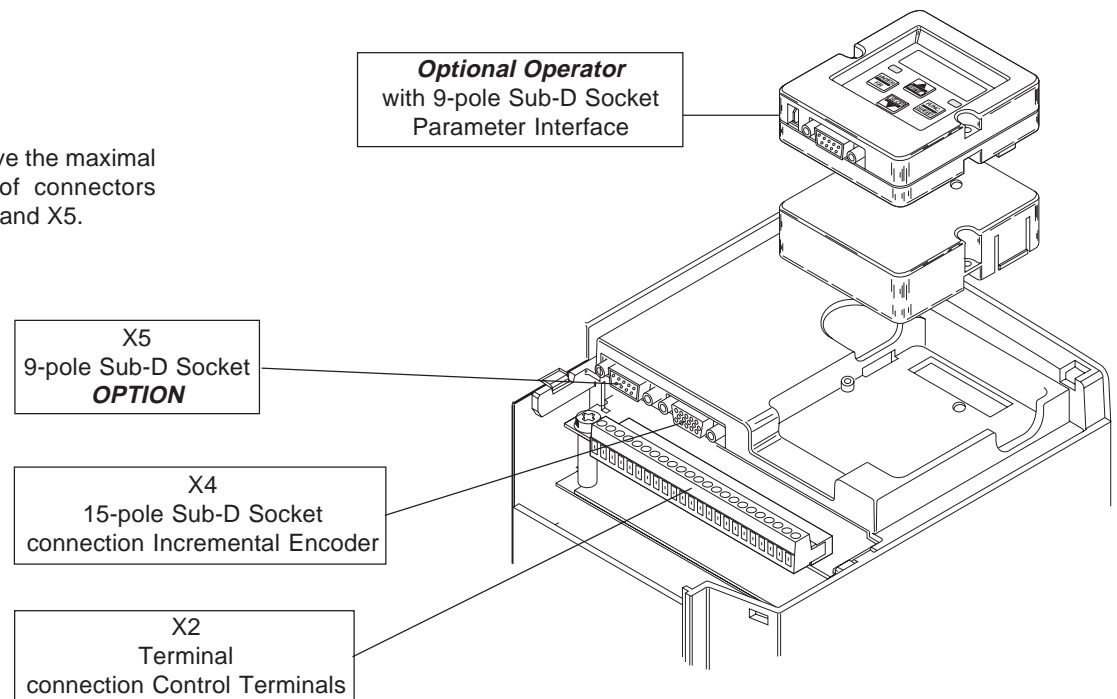

3.1.2 Control Cards

Depending on the housing size 2 variants of F4-F-control cards are available:

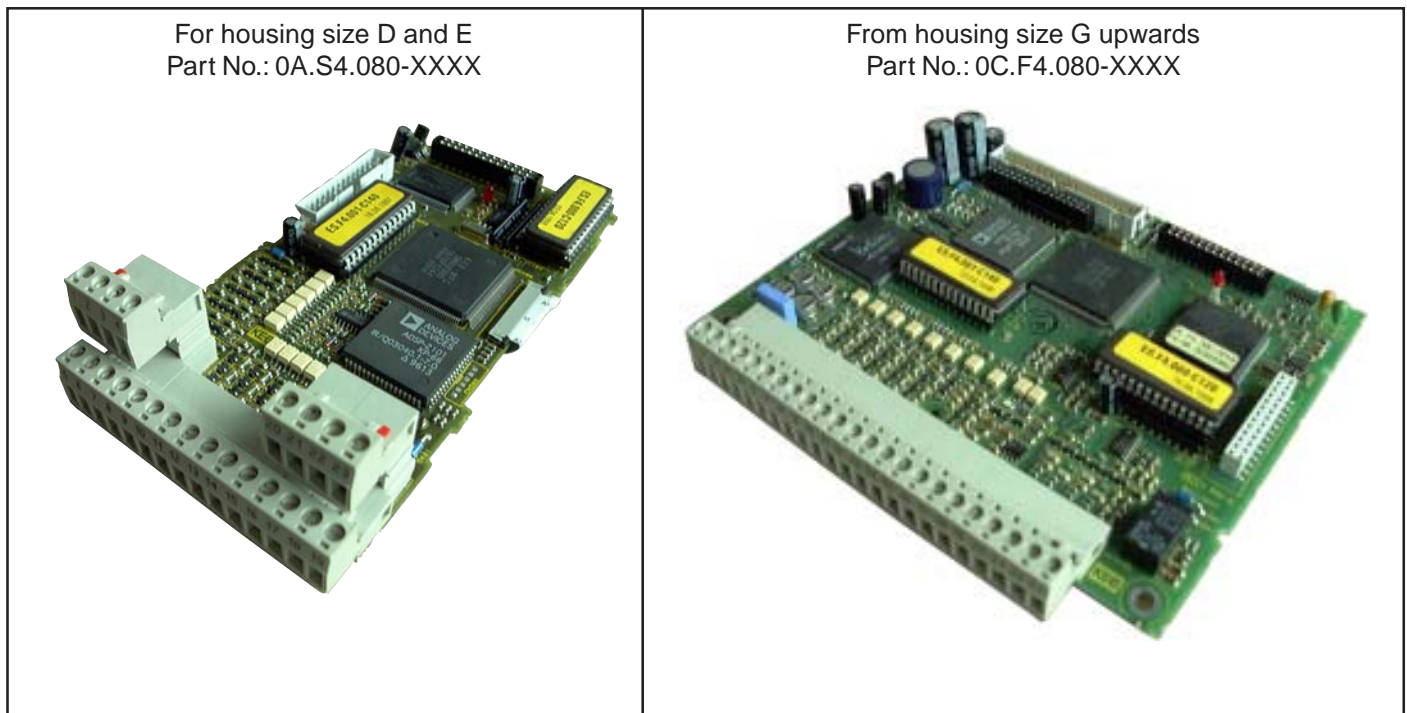

- 2 programmable transistor outputs
- 1 programmable relay output
- 6 programmable digital inputs
- 1 non-adjustable digital inputs
- 2 analog outputs
- 2 differential voltage inputs
- 2 voltage outputs
- separate supply

3.1.3 Control Terminal Strip X2

from housing size G upwards

for housing size D and E



Ter.	Name	Function	
1	ST	Control release	Digital Inputs logic 1: \pm (12...30V) internal input resistor: approx. 2 k Ω Logic: PNP/NPN (prog. with di. 1) (*1) Factory setting, also other functions can be assigned to the terminals (see chapter 6.3 „Digital inputs“) Scan time: 2ms
2	I4	Reset	
3	I5	Rotation selection / forward *1	
4	I6	Rotation selection / reverse *1	
5	I1	Programmable input 1 (Jog-speed forward *1)	
6	I2	Programmable input 2 (Jog-speed reverse *1)	
7	I3	Programmable input 3 (external fault *1)	
8	D1	Digital output 1 (Out 1)	programmable PNP-transistor outputs 14...30 V / max. 20 mA per output (see chapter 6.3 „Digital In- and Outputs“)
9	D2	Digital output 2 (Out 2)	
10	Uout	Voltage output	Voltage output: supply voltage provided by the inverter for digital in- and outputs Voltage: depending on power circuit and load 16...30V max.60 mA
11	0V	Mass for Uout and digital in-/outputs	
12	CRF	+10 V reference voltage	Voltage output: +10V (+/-3%); max. 4 mA Mass for analog in-/outputs
13	COM	Analogmass	
14	REF 1 +	Analog setpoint input	Differential voltage input \pm 10 V / resolution: 12 Bit / Ri = 24 k Ω / 40 k Ω (see next page) Current inputs can only be realized by external switch mode with load resistance (see chapter 6.2). Scan time: 2ms / At fast setpoint input and torque control: 128 μ s
15	REF 1 -	see An.2 - An.5 (chapter 5.9)	
16	REF 2 +	Prog. analog input	
17	REF 2 -	see An.8 - An.11 (chapter 5.9)	
18	A1	Analog output 1	Analog outputs Voltage range: 0... \pm 10V / internal resistance: 100 Ω Resolution: 10 bit (see chapter 6.2 „Analog outputs“) Scan time: 2ms
19	A2	Analog output 2	
20	RLA	Output relay (Out 3)	30 VDC / 1A (see chapter 6.3 „Digital In- and Outputs“)
21	RLB		
22	RLC		
23	Ext. Spg.	External voltage supply	External voltage input: Bezugspotential 0V (X2.11) external supply voltage for digital in-/outputs (only necessary if the voltage provided by the inverter is too low for a primary control or an external encoder) and for the supply of the control card at switched off power circuit (this function is not available for all power circuit sizes)

! Potential isolation between terminals for digital signals (X2.1 - X2.11, X2.23) and terminals for analog signals (X2.12 - X2.19).

! Release of rotation (X2.3 / X2.4) and torque limitation (prog. funktion for analog input 2 (X2.16 / X2.17)) do not have a function in the Drive-Mode (see chapter 4.4).

3.1.4 Wiring of Digital In-/Outputs

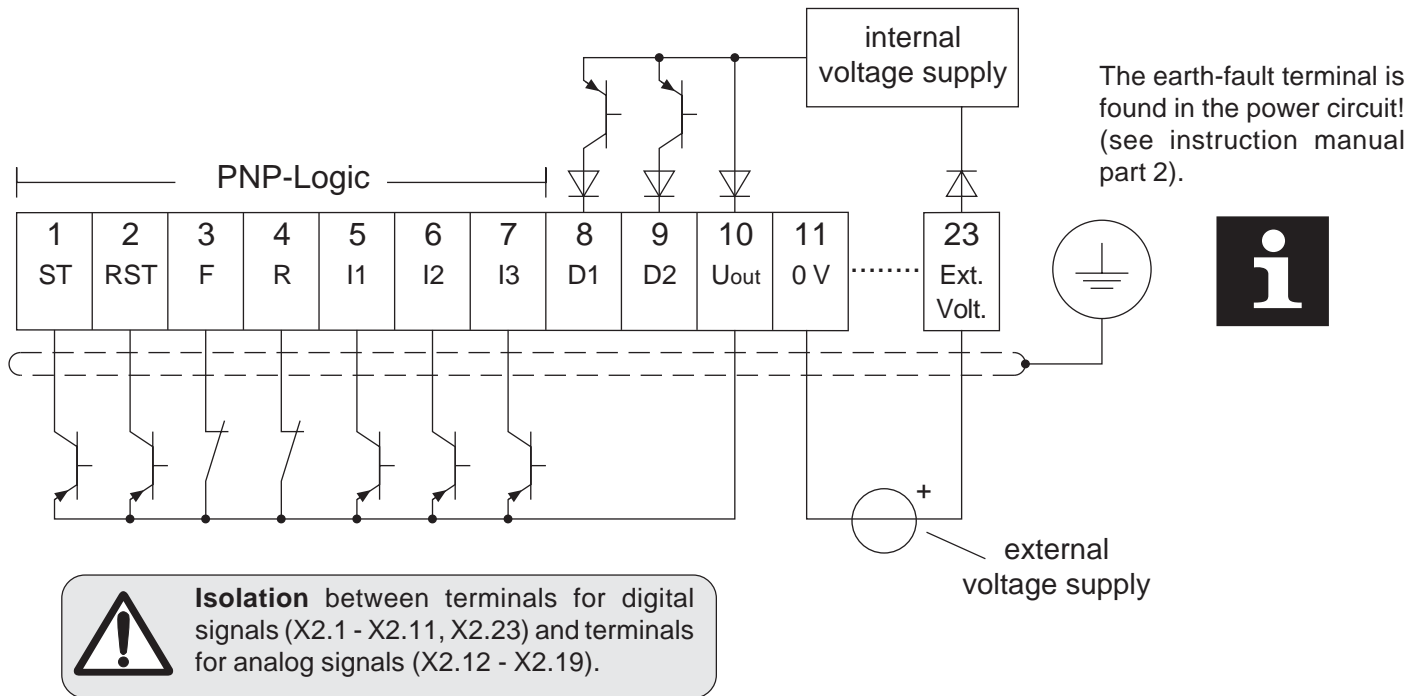

3.1.5 Wiring of Analog In-/Outputs

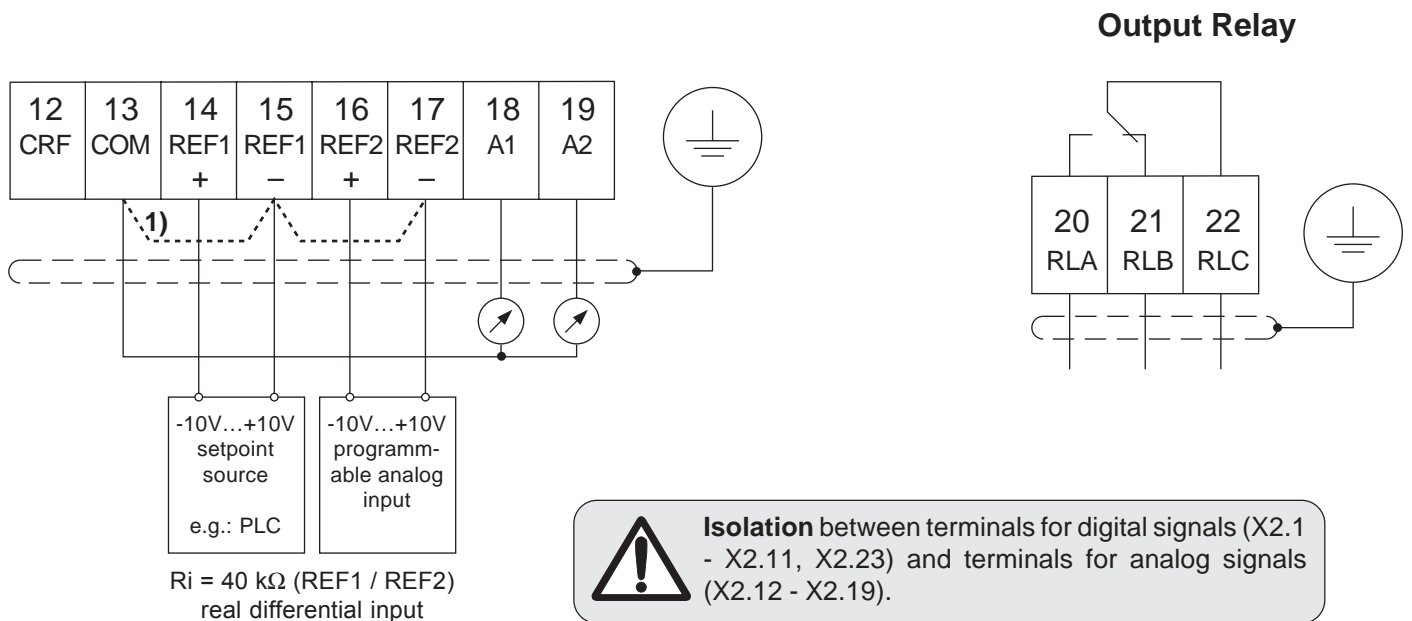

1) differential input with internal ground (COM)
 $R_i = 24\text{ k}\Omega$ (REF1 / REF2)

1. Introduction

2. Summary

3. Hardware

4. Operation

5. Parameter

6. Functions

7. Start-up

8. Special Operation

9. Error Assistance

10. Project Planning

11. Networks

12. Applications

13. Annex

4.1 Fundamentals

4.2 Password Structure

4.3 CP-Parameter

4.4 Drive-Mode

4.1.1 Parameters, Parameter Groups, Parameter Sets 3

4.1.2 Selection of a Parameter 4

4.1.3 Adjustment of Parameter Values 4

4.1.4 ENTER-Parameter 4

4.1.5 Non-programmable Parameters 5

4.1.6 Resetting of Error Messages.. 5

4.1.7 Resetting of Peak Values 5

4.1.8 Acknowledgement of Status Signals 5

Chapter 4	Section 1	Page 2	Date 18.12.02	Name: Basis KEB COMBIVERT F4-F	© KEB Antriebstechnik, 2002 All Rights reserved
---------------------	---------------------	------------------	------------------	--	--

4. Operation

4.1 Fundamentals

The following chapter describes the fundamentals of the software structure as well as the operation of the unit.

The control board F4-F incorporates 3 operating modes:

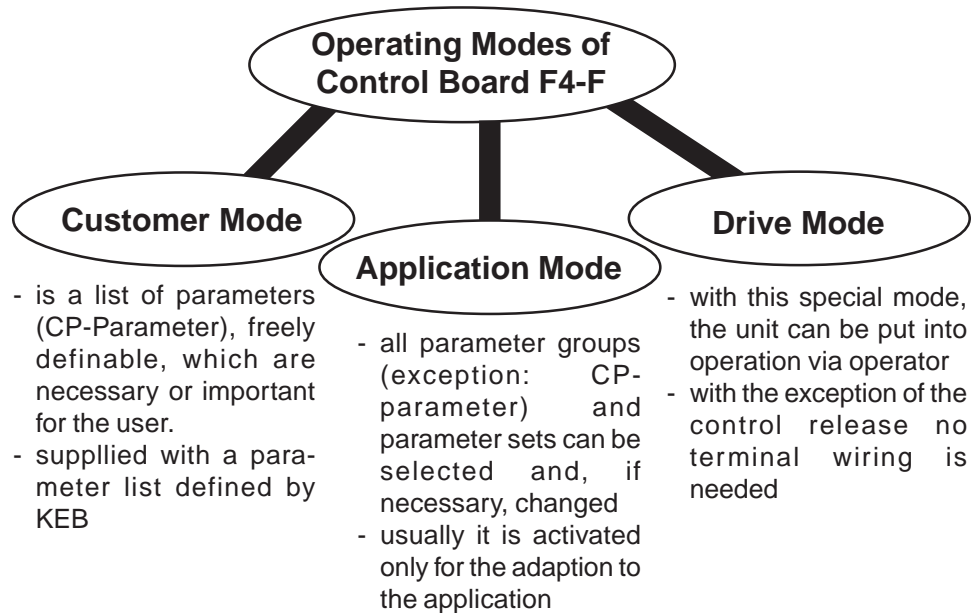

4.1.1 Parameters, Parameter Groups, Parameter Sets

What are parameters, parameter groups and parameter sets?

Parameters are values changeable by the operator in a program, which have an influence on the program flow. A parameter consists of

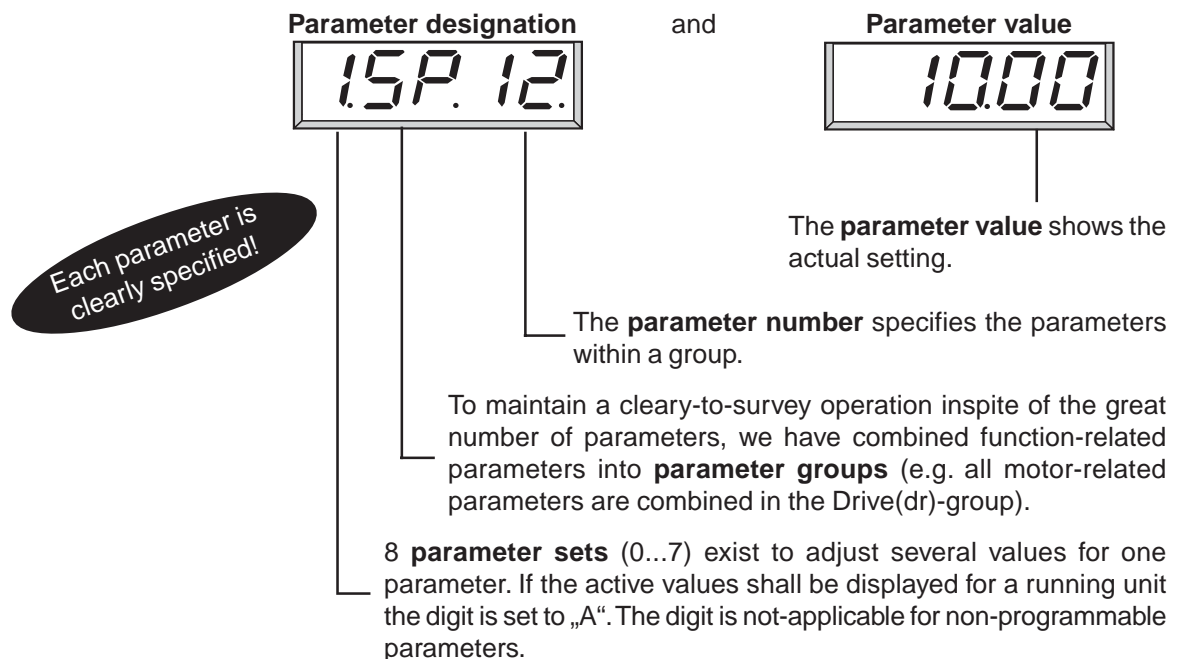

Example: A conveyor belt shall be used with 3 different speeds. A parameter set is programmed for each „speed“ ... acceleration, deceleration etc. can be adjusted individually.

4.1.2 Selection of a Parameter

The blinking point indicates the changeable area. By pressing the ENTER-key the blinking point is shifted.

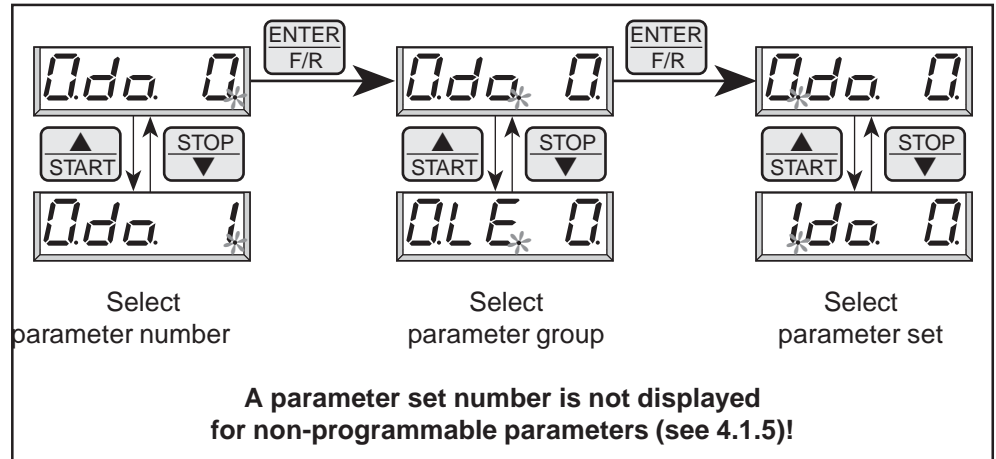

4.1.3 Adjustment of Parameter Values

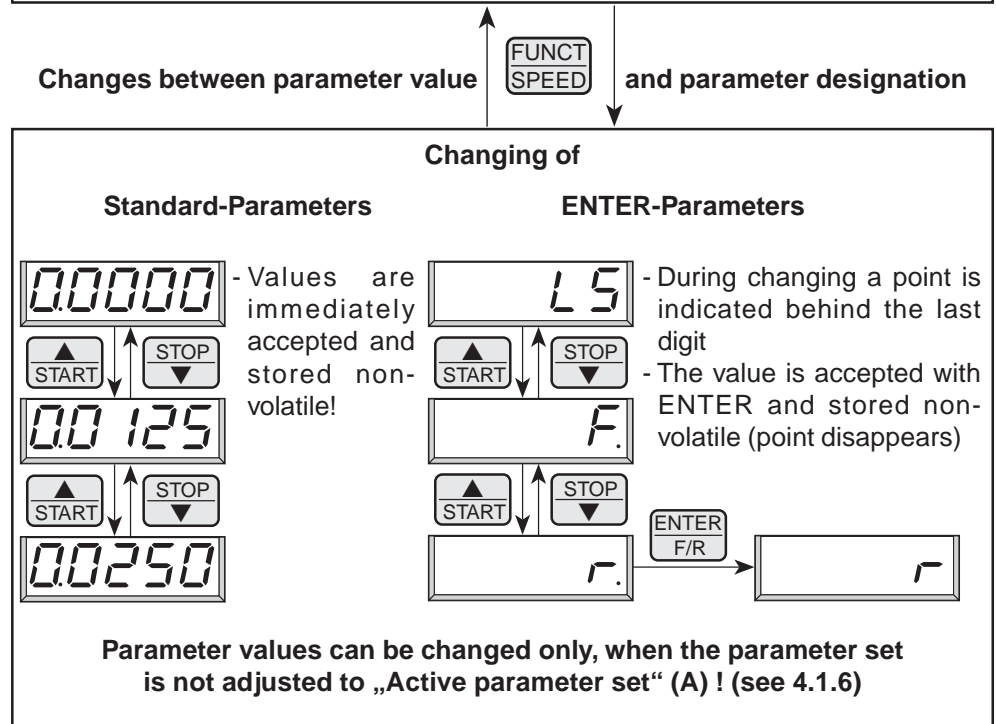

4.1.4 ENTER-Parameter

For some parameters it is not sensible that the selected values become active immediately. For that reason they are called ENTER-parameters, they do not become active until the ENTER-key is pressed.

Example: At digital setting of rotation direction the rotation reverse (r) shall be selected from standstill (LS). As shown above, the actuation must be done via rotation forward (F). However, the drive must not start yet, first the rotation direction reverse has to be selected and confirmed with ENTER (point disappears).

4.1.5 Non-programmable Parameters

Certain parameters are not programmable, as their value must be the same in all sets (e.g. bus address or baud rate). For an easy identification of these parameters the parameter set number is missing in the parameter identification. **For all non-programmable parameters the same value is valid independent of the selected parameter set!**

4.1.6 Resetting of Error Messages

If a malfunction occurs during operation, the actual display is overwritten by a blinking error message. The error message can be cancelled by pressing the ENTER-key, so that the original value is again shown in the display.

ATTENTION! The resetting of the error message with ENTER is no error reset, i.e. the error status in the inverter is not reset. Thus it is possible to correct adjustments before the error reset. An error reset is only possible through the reset terminal or control release (see chapter 6.3.1 „Short Description Digital Inputs“).

4.1.7 Resetting of Peak Values

To permit conclusions on the operational performance of the drive, parameters are provided that indicate the peak values. Peak value means that the highest measured value is stored for the ON-time of the inverter (slave pointer principle). The peak value is cancelled by ▲ or ▼ and the actual measured value is shown in the display.

4.1.8 Acknowledgement of Status Signals

To monitor the correct execution of an action some parameters send a status signal. For example, after copying a set the display shows „PASS“ to indicate that the action was carried out without error. These status signals must be acknowledged with ENTER.

Chapter 4	Section 1	Page 6	Date 18.12.02	Name: Basis KEB COMBIVERT F4-F	© KEB Antriebstechnik, 2002 All Rights reserved
---------------------	---------------------	------------------	------------------	--	--

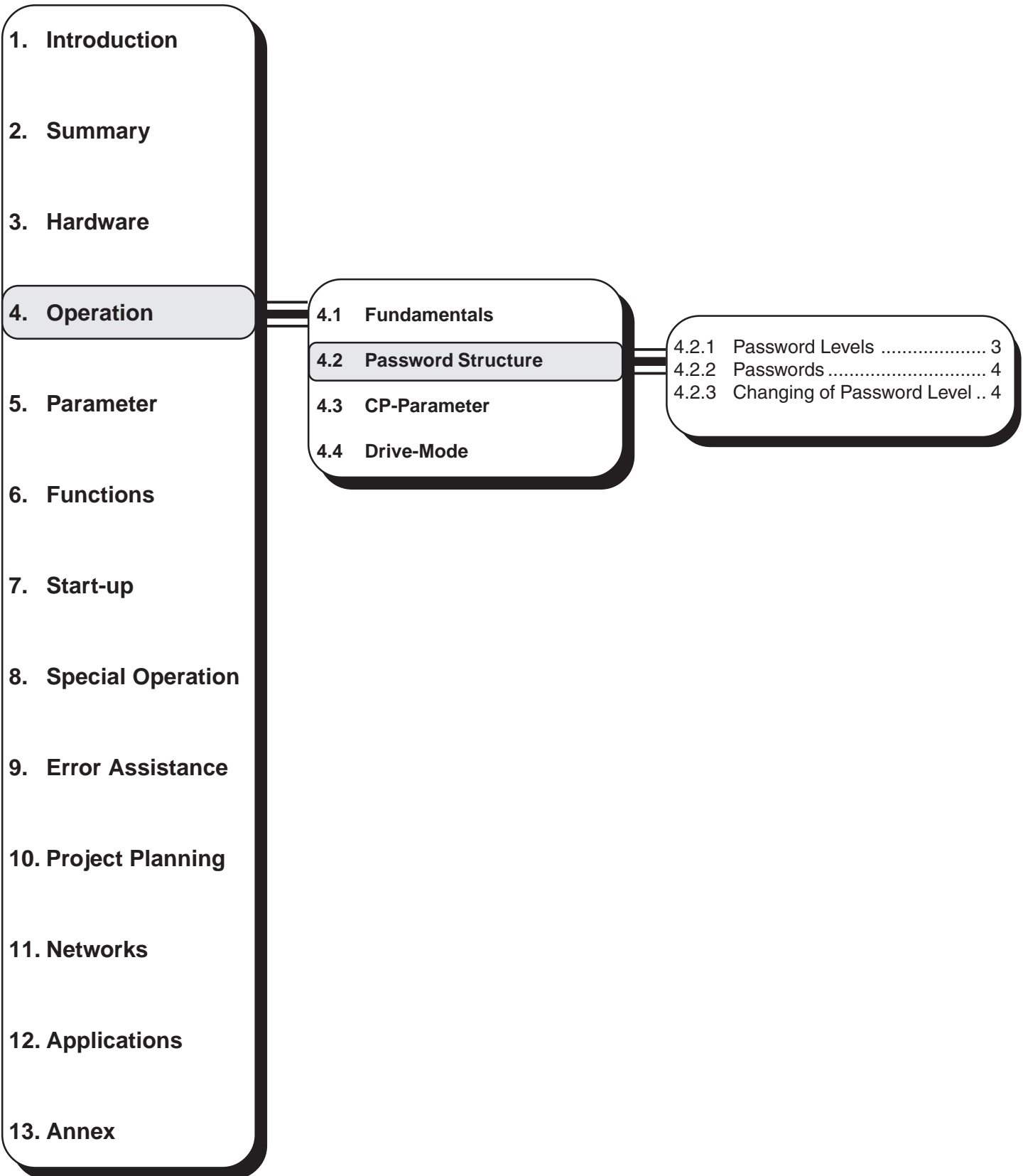

Chapter 4	Section 2	Page 2	Date 18.12.02	Name: Basis KEB COMBIVERT F4-F	© KEB Antriebstechnik, 2002 All Rights reserved
---------------------	---------------------	------------------	------------------	--	--

4.2 Password Structure

The KEB COMBIVERT is provided with extensive password protection. The different passwords are used to

- change the operating mode
- set a write protection
- activate the Service-Mode
- switch to the Drive-Mode

Depending on the actual operating mode the password can be entered in following parameters



when the CP-Mode is active



when the application mode is active

4.2.1 Password Levels

The parameter value of the above parameters shows the actual password level. Following indications are possible:



CP - read only

Only the Customer-parameter group is visible, except for CP.0 all parameters are in the read-only status (see Chapter 4.3).



CP - on

Only the Customer-parameter group is visible. All parameters can be changed.



CP - Service

Like CP-on, but the parameter identification is indicated according to the original parameter (see Chapter 4.3).



Application

All application parameters are visible and can be changed. The CP-parameters are not visible.

Drive-Mode

The Drive-Mode is a special operating mode, here the unit can be put into operation via the operator (see Chapter 4.4).

4.2.2 Passwords

By selecting one of the following passwords in CP.0 or ud.1 you can switch to the respective password level:

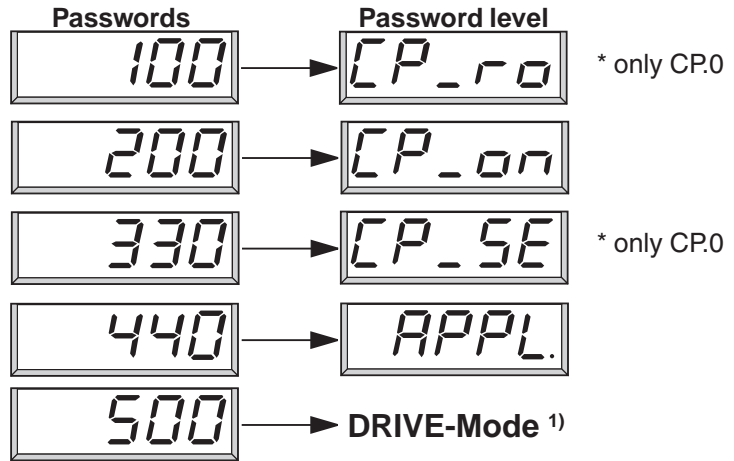

- 1) To finish the Drive-Mode press ENTER + FUNCT key for approx. 3 sec. (see Chapter 4.4).

4.2.3 Changing of Password Level

Example 1:
Switching from CP-Mode to the application mode

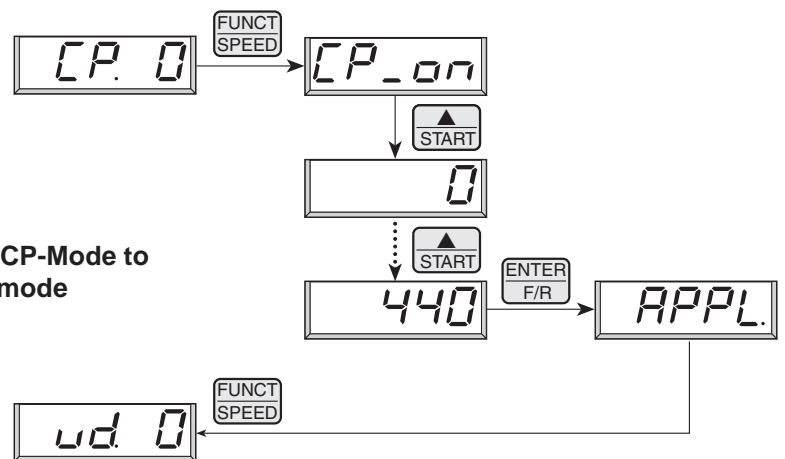

Example 1:
Switching from application mode to the CP-read-only mode

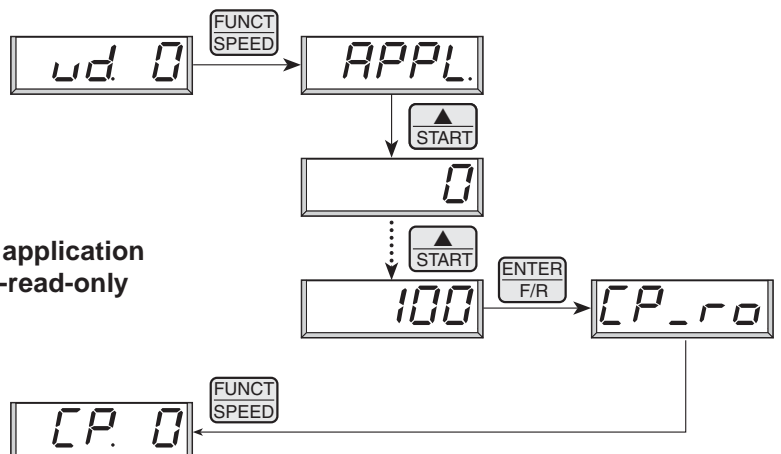

1. Introduction																
2. Summary																
3. Hardware																
4. Operation	<table border="1"> <tr> <td>4.1 Fundamentals</td> <td></td> </tr> <tr> <td>4.2 Password Structure</td> <td></td> </tr> <tr> <td>4.3 CP-Parameter</td> <td> <table border="1"> <tr> <td>4.3.1 Operation in CP-Mode</td> <td>3</td> </tr> <tr> <td>4.3.2 Factory Setting</td> <td>3</td> </tr> <tr> <td>4.3.3 Description of CP-Parameter</td> <td>5</td> </tr> </table> </td> </tr> <tr> <td>4.4 Drive-Mode</td> <td></td> </tr> </table>	4.1 Fundamentals		4.2 Password Structure		4.3 CP-Parameter	<table border="1"> <tr> <td>4.3.1 Operation in CP-Mode</td> <td>3</td> </tr> <tr> <td>4.3.2 Factory Setting</td> <td>3</td> </tr> <tr> <td>4.3.3 Description of CP-Parameter</td> <td>5</td> </tr> </table>	4.3.1 Operation in CP-Mode	3	4.3.2 Factory Setting	3	4.3.3 Description of CP-Parameter	5	4.4 Drive-Mode		
4.1 Fundamentals																
4.2 Password Structure																
4.3 CP-Parameter	<table border="1"> <tr> <td>4.3.1 Operation in CP-Mode</td> <td>3</td> </tr> <tr> <td>4.3.2 Factory Setting</td> <td>3</td> </tr> <tr> <td>4.3.3 Description of CP-Parameter</td> <td>5</td> </tr> </table>	4.3.1 Operation in CP-Mode	3	4.3.2 Factory Setting	3	4.3.3 Description of CP-Parameter	5									
4.3.1 Operation in CP-Mode	3															
4.3.2 Factory Setting	3															
4.3.3 Description of CP-Parameter	5															
4.4 Drive-Mode																
5. Parameter																
6. Functions																
7. Start-up																
8. Special Operation																
9. Error Assistance																
10. Project Planning																
11. Networks																
12. Applications																
13. Annex																

Chapter 4	Section 3	Page 2	Date 18.12.02	Name: Basis KEB COMBIVERT F4-F	© KEB Antriebstechnik, 2002 All Rights reserved
---------------------	---------------------	------------------	------------------	--	--

4.3 CP-Parameter

The Customer-Parameters (CP) are a special group of parameter. With the exception of CP.0 (Password input), they can be defined by the user. The following Parameters are preset at delivery.

Advantages from it: - operator-friendly for the customer
- critical parameters are protected against maloperation
- low documentation cost for the machine builder

4.3.1 Operation in CP-Mode

Compared to the Application-Mode the operation in the CP-Mode is easier because parameter set selection and parameter group selection are unnecessary.

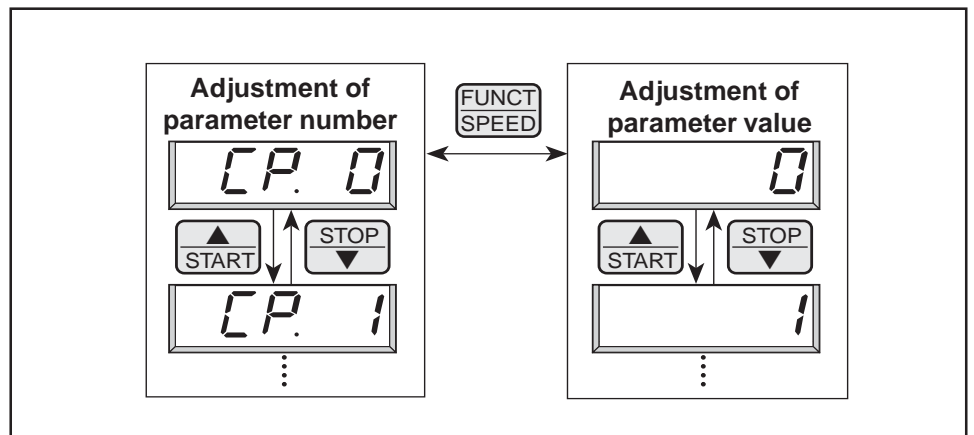

4.3.2 Factory Setting

The following list shows the CP-parameter group predefined by us. The definition of the CP-parameters is done in the User-Definition-Parameters (ud). How you can define your own parameters is described in Chapter 6.12 „CP-Parameter Definition“.

Parameter Number	Parameter Description	Adjustment Range	Resolution	Factory Setting
CP.0	Password Input	0...9999	1	–
CP.1	Actual speed display	–	0,5 rpm	–
CP.2	Status display	–	–	–
CP.3	Apparent motor current	–	0,1 A	–
CP.4	Max. apparent motor current	–	0,1 A	–
CP.5	Actual torque display	–	0,1 Nm	–
CP.6	Speed reference display	–	0,5 rpm	–
CP.7	Acceleration time	0...320 s	0,01 s	2,0 s
CP.8	Deceleration time	0...320 s	0,01 s	2,0 s
CP.9	Torque limit	0...5 x M _N Nm	0,1 Nm	dependent on size
CP.10	Maximum setpoint speed	0...9999,5 rpm	0,5 rpm	2100 rpm
CP.11	Jogging speed	0...9999,5 rpm	0,5 rpm	100 rpm
CP.12	P-factor speed controller	0...65535	1	400
CP.13	I-factor speed controller	0...65535	1	200
CP.14	Encoder 1 (inc/r)	256...10000	1	2500
CP.15	Behaviour at external fault	0...6	1	0
CP.16	Offset REF 1	-100...+100 %	0,1 %	0 %
CP.17	Zero point hysteresis REF 1	0...10 %	0,1 %	0,2 %
CP.18	Function output A1	0...10	1	2
CP.19	Gain output A1	-20...+20	0,01	1
CP.20	Gain output A2	-20...+20	0,01	1
CP.21	Output condition D1	0...33	1	20
CP.22	Output condition D2	0...33	1	18
CP.23	Torque level D1	0...2000 Nm	0,1 Nm	0 Nm
CP.24	Speed level D2	0...9999,5 rpm	0,5 rpm	0 rpm
CP.25	Rated motor power	0,01...75 kW	0,01 kW	dependent on size
CP.26	Rated motor speed	100...9999,5 rpm	1 rpm	dependent on size
CP.27	Rated motor current	0,1...50 A	0,1 A	dependent on size
CP.28	Rated motor frequency	20...300 Hz	1 Hz	dependent on size
CP.29	Rated motor cos (Phi)	0,05...1	0,01	dependent on size
CP.30	Rated motor voltage	100...400 V	1 V	400 V
CP.31	Load motor dependent parameter	0...2	1	0
CP.32	Speed control on/off	0...1	1	0
CP.33	Boost	0...25,5 %	0,1 %	2 %
CP.34	Change encoder 1 rotation	0...1	1	0
CP.35	Reaction to limit switch	0...6	1	6
CP.36	Aux function	0...96	1	0

¹⁾ Resolution means the program internal resolution of parameters.

The accuracy of the detection / calculation of the parameter values may be worse than the resolution.

²⁾ See table for parameter values that are dependent on the size (page GB 35)!



Due to the calculation / measuring accuracies, tolerances with the current and torque displays as well as with the switching levels and limitations, must be taken into consideration. The given tolerances (see parameter description) refer to the respective maximum values with the dimensioning KEB COMBIVERT: Motor = 1:1.

Dependent on the data from the motor manufacturer, larger tolerances at the torque displays are possible, due to the usual variations in the machine parameters and temperature drifts.

4.3.3 Description of CP-Parameter

Preadjusted CP-parameters are described in the following section.

Password input



On delivery all CP-parameters are without password protection, i.e. all changeable parameters can be readjusted. After the parameterization the unit can be locked against unauthorized access. The adjusted mode is stored.

Locking of CP-Parameter

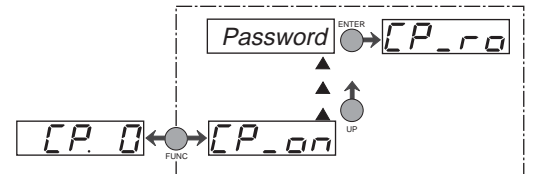

Enabling of CP-Parameter

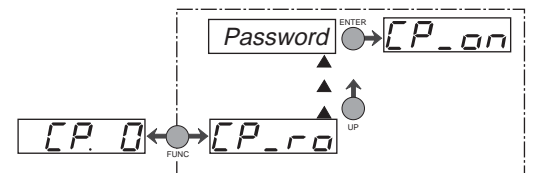

Actual Speed Display



Display of the actual motor speed (incremental encoder).

For a correct display value, observe the adjustment of encoder 1 (inc/r) (CP.14) and the change encoder 1 rotation (CP.34) of the incremental encoder!

Example:

Display	Direction of Rotation	Actual Motor Speed	Resolution of Display
1837.5	"forward"	1837,5 rpm	0,5 rpm
- 1837	"reverse"	1837,0 rpm or 1837,5 rpm	1 rpm (The internal resolution of the speed is 0.5 rpm)

Status Display



Shows the actual operating state of the inverter. Possible displays and their meaning: (Further state messages see chapter 6.1.5)

noP	no Operation	<ul style="list-style-type: none"> - Control release (terminal X2.1) not activated - Modulation off - Output voltage = 0 V/drive uncontrolled 	
FAcc	Forward Acceleration	Drive accelerates forward	
FdEc	Forward deceleration	Drive decelerates forward	
rAcc	reverse Acceleration	Drive accelerates in reverse	
rdEc	reverse deceleration	Drive decelerates in reverse	
Fcon	Forward constant	Drive runs with constant speed and forward	
rcon	reverse constant	Drive runs with constant speed and reverse	
bbl	Base-Block Time	The Base-Block-Time (motor suppression time) runs out. The power transistors are locked.	
A b n o r m a l S t o p p i n g	A EF	external fault	The external fault is triggered (terminal X2.7). The drive's response to external errors is adjusted in parameter CP.15.
	AP-rF	Prohibited rotation forward	Rotation release on terminal X2.3 is missing: Drive does not start with positive setpoint and/or decelerates until standstill. See also parameter CP.35
	AP-rr	Prohibited rotation reverse	Rotation release on terminal X2.4 missing: Drive does not start with negative setpoint and/or decelerates until standstill. See also parameter CP.35

Apparent Motor Current



Displays the actual apparent current in ampere.

Resolution: 0,1 A
max. tolerance: approx. ±10 %

Max. Apparent Motor Current



Displays the maximum apparent motor current, which is measured during operation. The display is in ampere.

During operation, using **UP** (▲) or **DOWN** (▼) you can reset the peak value. The peak value is deleted when the unit is POWER OFF.

Resolution: 0,1 A
max. tolerance: approx. ±10 %

Actual Torque Display



Displays the actual torque in newtonmeter. During open-loop operation (CP.32 = 0) value 0 is always shown.

Resolution: 0,1 Nm
 max. tolerance: approx. ±30 % in base speed range (see page 4.3.4)
 (In the field weakening range larger tolerances are possible)

Speed Reference Display



Displays the speed reference at the output of the ramp generator in rpm. When the modulation is switched off the setpoint 0 rpm is displayed.

Resolution: 0,5 rpm
 positive speed: direction of rotation "forward"
 negative speed: direction of rotation "reverse"

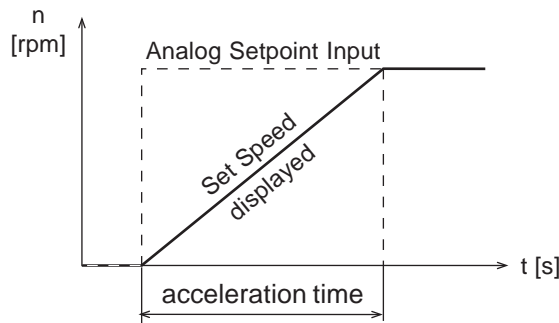

Acceleration Time



Defines the time needed to accelerate from 0 to 1000 rpm. The actual acceleration time is proportional to the speed change (Δ n).

Adjustment Range: 0...320 s
 Resolution: 0,01 s
 Factory setting: 2,0 s
 Customer setting: _____ s

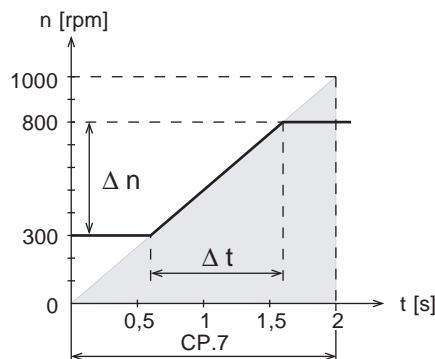

Δ n speed change
 Δ t acceleration time for Δ n

$$CP.7 = \frac{\Delta t}{\Delta n} \times 1000 \text{ rpm}$$

Example:

The drive should accelerate from 300 rpm to 800 rpm in 1 s.

Δ n = 800 rpm - 300 rpm = 500 rpm
 Δ t = 1 s

$$CP.7 = \frac{\Delta t}{\Delta n} \times 1000 \text{ rpm} = \frac{1 \text{ s}}{500 \text{ rpm}} \times 1000 \text{ rpm} = 2 \text{ s}$$

Deceleration Time

CP. 8

Defines the time needed to decelerate from 1000 to 0 rpm. The actual deceleration time is proportional to the speed change (Δn).

Adjustment Range:	0...320	s
Resolution:	0,01	s
Factory setting:	2,0	s
Customer setting:	_____	s

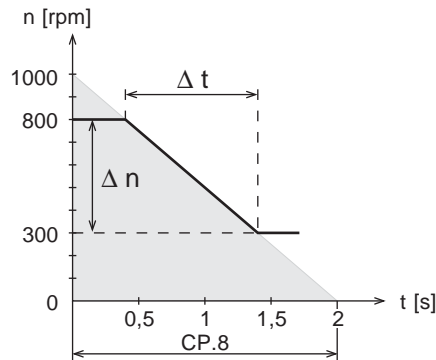

Δn speed change
 Δt deceleration for Δn

$$CP.8 = \frac{\Delta t}{\Delta n} \times 1000 \text{ rpm}$$

Example:

The drive should decelerate from 800 rpm to 300 rpm in 1 s.

$$\Delta n = 800 \text{ rpm} - 300 \text{ rpm} = 500 \text{ rpm}$$

$$\Delta t = 1 \text{ s}$$

$$CP.8 = \frac{\Delta t}{\Delta n} \times 1000 \text{ rpm} = \frac{1 \text{ s}}{500 \text{ rpm}} \times 1000 \text{ rpm} = 2 \text{ s}$$

Torque Limit

CP. 9

Adjusts the maximum permissible torque of the drive. The parameter can be influenced by the analog torque limitation. **During open-loop operation (CP.32 = 0) this parameter has no function.**

Adjustment Range:	0...5 x M_N	Nm
Resolution:	0,1	Nm
Factory setting:	dependent on size	
Customer setting:	_____	Nm

max. tolerance: approx. $\pm 20\%$ in base speed range

(In the field weakening range larger tolerances are possible, also see reference on page 4)

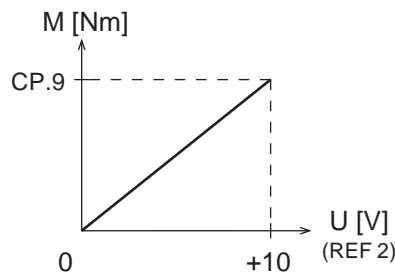

Analog Limiting
 Terminals X2.16 / X2.17
! only when CP.36 = 5 !



The maximum torque of the drive is limited by the following:

- *Dimensioning KEB COMBIVERT – Motor*

If KEB COMIBVERT is dimensioned too small the torque is automatically limited due to a motor current which is too low.

- *Programming the Motor Parameters CP.25 - CP.30*

Dependent on the adjusted motor data a speed-dependent limit curve (see below) is set. The value of the calculated maximum torque is automatically written in parameter CP.9

Parameter CP.31 (Load motor dependent parameter) activates the motor data and the respective limit curve.

See table on page 23 for the factory setting of the motor parameter!

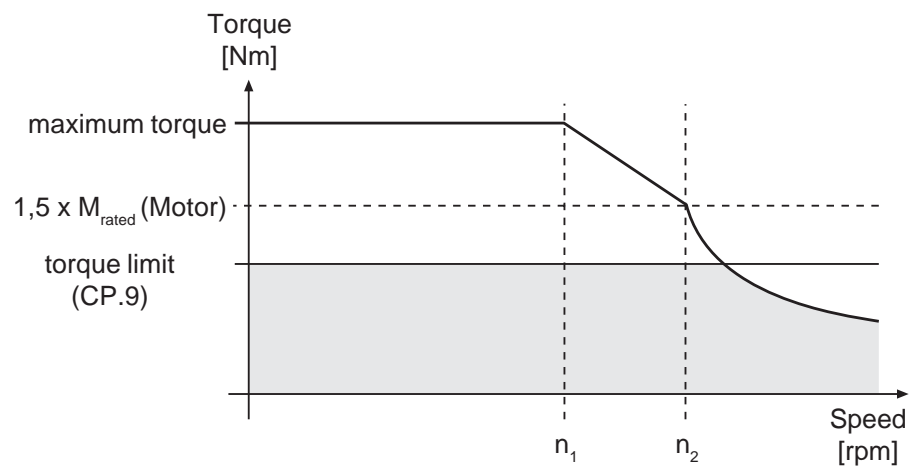

$$n_1 = 0,6 \times n_{in} \times \frac{U_{\text{rated}}}{\text{CP.30}}$$

$$n_2 = 0,86 \times n_{in} \times \frac{U_{\text{rated}}}{\text{CP.30}}$$

n_{in} Nominal-Rotating Field Speed
 U_{rated} Inverter Rated Voltage
 CP.30 Motor Rated Voltage

Maximum Setpoint Speed

CP.10

Defines the maximum setpoint speed.

Adjustment Range:	0...9999,5	rpm
Resolution:	0,5	rpm
Factory setting:	2100	rpm
Customer setting:	_____	rpm

Analog setpoint
[rpm]

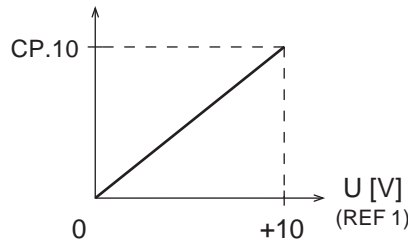

Analog setpoint presetting: REF 1 terminals X2.14 + X2.15



Only the reference speed is limited by this parameter. The actual speed can exceed this value because of control oscillations or a fault in the speed detection.

Jog-Speed

CP.11

Specifies a jogging speed (fixed speed), which can be activated by the digital inputs I1 (forward) or I2 (reverse). If both rotations are simultaneously preset, 'forward' has priority.

Adjustment Range:	0...9999,5	rpm
Resolution:	0,5	rpm
Factory setting:	100	rpm
Customer setting:	_____	rpm

Function:

I1 or I2 active ⇒ The drive runs with an adjusted jogging speed.

- The original direction of rotation, speed, acceleration and deceleration times do not have a function!
- ACC and DEC times only have limited functions (see the following table)!
- If the jogging speed entered is too high, the adjusted value is internally limited onto the maximum permissible motor speed!
- The software limit switches (see CP.35) remain active!

I1 and I2 not active ⇒ The drive runs with the analog reference speed.

Input I1 / I2	Speed Ratio	Acceleration/Deceleration Performance
is activated	Actual speed dis. (CP.1) < Jogging speed (CP.11)	drive accelerates on the torque limit
is activated	Actual speed dis. (CP.1) > Jogging speed (CP.11)	drive accelerates in accord. with the adjusted ramp
is deactivated	Speed reference dis. (CP.6) < Jogging speed (CP.11)	drive decelerates on the torque limit
is deactivated	Speed reference dis. (CP.6) > Jogging speed (CP.11)	drive accelerates in accord. with the adjusted ramp

P-Factor Speed Controller

CP.12

Proportional factor of the speed controller.

Adjustment Range: 0...65535
 Resolution: 1
 Factory setting: 400
 Customer setting: _____

! see also parameter CP.36 !

I-Factor Speed Controller

CP.13

Integral factor of the speed controller.

Adjustment Range: 0...65535
 Resolution: 1
 Factory setting: 200
 Customer setting: _____

! see also parameter CP.36 !

Encoder 1 (inc/r)

CP.14

Adjusts the increments of the incremental encoder used. Check the set and actual speed displays during open-loop operation and compare.
 The correct setting is: actual speed = set speed - slip

Adjustment Range: 256...10000
 Resolution: 1
 Factory setting: 2500
 Customer setting: _____

Behaviour at External Fault



This parameter determines how the drive reacts to an external error (digital Input I3).

Adjustment Range: 0..6
 Resolution: 1
 Factory setting: 0
 Customer setting: _____
 Note: **ENTER-Parameter**

Value	Error / Status message	Response of the drive
0	E.EF	modulation immediately switched off ! To restart remove error and activate Reset !
1	A.EF	quick stop / modulation switched off after speed 0 is reached ! To restart remove error and activate Reset !
2	A.EF	quick stop / holding torque at speed 0 ! To restart remove error and activate Reset !
3	A.EF	modulation immediately switched off ! Automatic restart , when error is no longer present !
4	A.EF	quick stop / modulation switched off after speed 0 is reached ! Automatic restart , when error is no longer present !
5	A.EF	quick stop / holding torque at speed 0 ! Automatic restart , when error is no longer present !
6	none	no effect on the drive ! Fault is ignored !



Quick stop



deceleration at the torque limit (CP.9)

Offset REF 1

CP.16

Makes it possible to shift the speed setpoint curve.

Adjustment Range:	-100...+100	%
Resolution:	0,1	%
Factory setting:	0	%
Customer setting:	_____	%

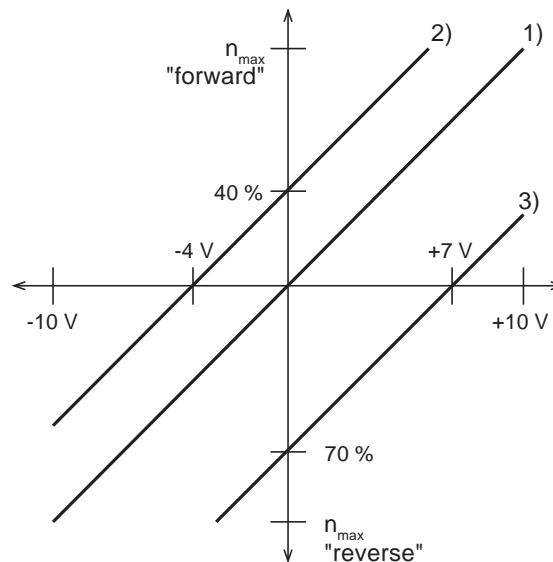
**Examples:**Curve 1: CP.16 = 0% (Standard adjustment)

0V = 0 rpm

Direction of rotation "forward": n_{max} is reached at +10VDirection of rotation "reverse": n_{max} is reached at -10VCurve 2: CP.16 = -40%0V = -40 % of n_{max} "forward"Direction of rotation "forward": n_{max} is reached at 60% of +10VDirection of rotation "reverse": maximum 60% of n_{max} possibleCurve 3: CP.16 = +70%0V = 70 % of n_{max} "reverse"Direction of rotation "forward": maximum 30% of n_{max} possibleDirection of rotation "reverse": n_{max} is reached at 30% of -10V

Zero Point Hysteresis REF 1

CP.17

CP.17 adjusts a zero point hysteresis of the setpoint input REF1. Voltage fluctuations and ripple voltages near the zero point of the setpoint do not cause the motor to shift.

Adjustment Range:	0...10	%
Resolution:	0,1	%
Factory setting:	0	%
Customer setting:	_____	%

This function has a switching hysteresis of 50%. If the analog signal is larger than the adjusted hysteresis value (CP.17), then the analog value is active. If the analog signal goes below 50% of the adjusted hysteresis value (0.5 x CP.17), then the analog setpoint is set at 0.

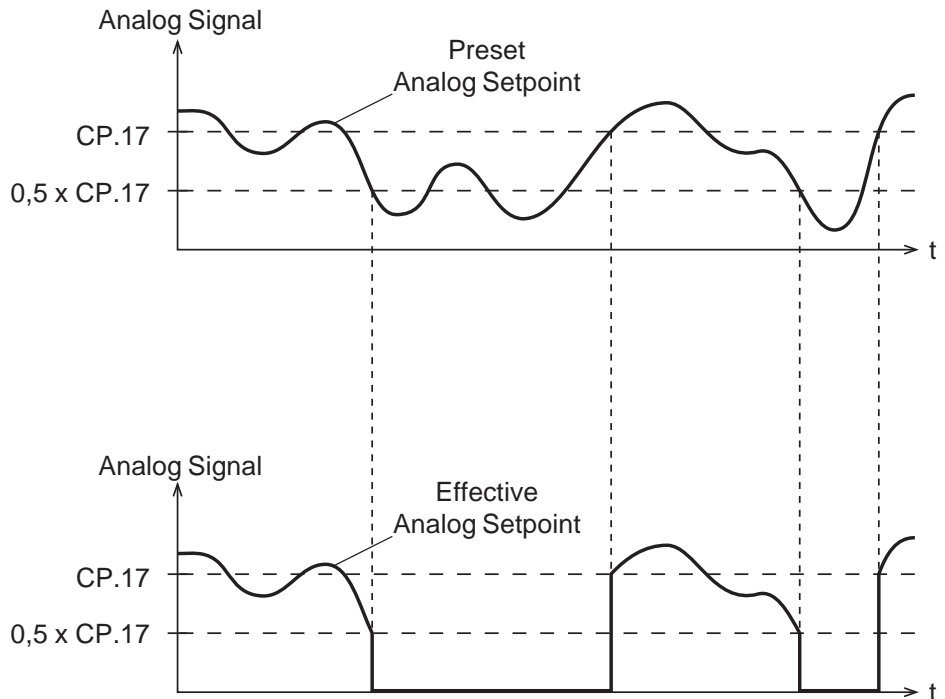

for CP.17 the following is valid:
 0...10 % $\hat{=}$ 0...±1 V

Function Output A1



Defines which variable is displayed on analog output 1 (terminal X2.18).

Adjustment Range: 0...10
 Resolution: 1
 Factory setting: 2
 Customer setting: _____
 Note: **ENTER-Parameter**

Value	Output Variable	Value Range when CP.19 = 1
0	Actual speed	$-2 \cdot n_{fn} \dots +2 \cdot n_{fn} \hat{=} -10V \dots +10V$
1	Motor apparent current	$0 \dots 2 \cdot I_{SN} \hat{=} 0 \dots +10V$
2	Actual torque	$-2 \cdot M_N \dots +2 \cdot M_N \hat{=} -10V \dots +10V$
3	DC-bus voltage	$0 \dots 1000 V \hat{=} 0 \dots +10V$
4	Speed reference (CP.6)	$-2 \cdot n_{fn} \dots +2 \cdot n_{fn} \hat{=} -10V \dots +10V$
5	Control difference (speed controller)	$-2 \cdot n_{fn} \dots +2 \cdot n_{fn} \hat{=} -10V \dots +10V$
6	Set torque	$-2 \cdot M_N \dots +2 \cdot M_N \hat{=} -10V \dots +10V$
7	Modulation depth	$0 \dots 100 \% \hat{=} 0 \dots 10V$
8	Position	- in the CP-Mode no funktion-
9	Speed in front of ramp	$-2 \cdot n_{fn} \dots +2 \cdot n_{fn} \hat{=} -10V \dots +10V$
10	REF1 output	$-10V \dots +10V \hat{=} -10V \dots +10V$

n_{fn} : Rated-Rotating Field Speed

M_N : Rated Torque

I_{SN} : Rated-Motor Apparent Current



During open-loop operation (CP.32 = 0) the analog output A1 has no function with the values 2,5, and 6.

Gain Output A1

CP.19

The parameter CP.19 specifies the gain of the analog output signal on output A1 (terminal X2.18).

Adjustment Range: -20...+20
 Resolution: 0,01
 Factory setting: 1
 Customer setting: _____

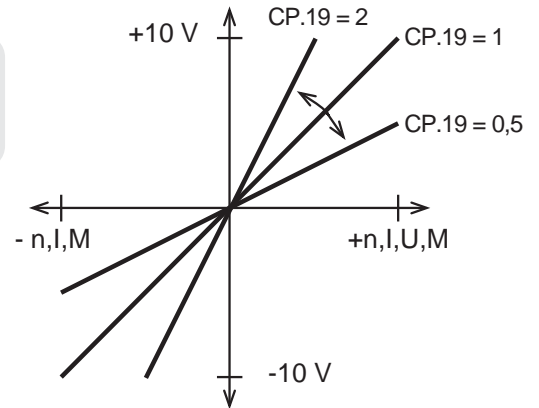

Calculation example:

When $1.5 \times M_{\text{rated}} + 10 \text{ V}$ should be measured on analog output A1.

$$\text{CP.19} = \frac{\text{value when gain is 1 (see CP.18)}}{\text{desired value at +10V}} = \frac{2 \times M_{\text{rated}}}{1.5 \times M_{\text{rated}}} = 1.33$$

Gain Output A2

CP.20

Determines the gain of the analog output signal A2 (terminal X2.19). The analog output A2 specifies the actual speed of the motor.

Adjustment Range: -20...+20
 Resolution: 0,01
 Factory setting: 1
 Customer setting: _____

for gain 1
 the following is valid:
 $\pm(2 \cdot n_{rn}) \hat{=} \pm 10 \text{ V}$

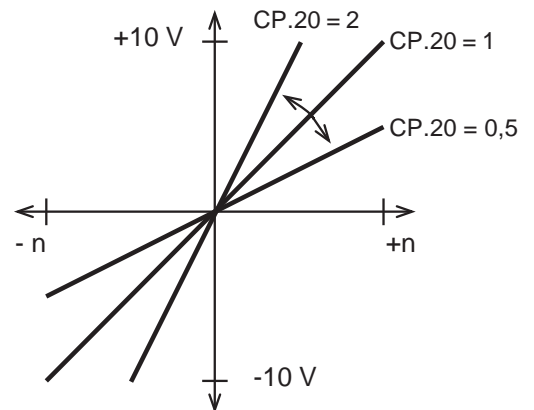

n_{rn} : Rated-Rotating Field Speed

See CP.19 for calculation example

Output Condition OUT D1

CP.21

Parameter CP.21 determines the output condition of digital output D1 (terminal X2.8).
! see table below !

Adjustment Range: 0...33
 Resolution: 1
 Factory setting: 20
 Customer setting: _____

Output Condition OUT D2



Parameter CP.22 determines the output condition of digital output D2 (terminal X2.9). **! see table below !**

Adjustment Range:	0...33
Resolution:	1
Factory setting:	18
Customer setting:	_____

Value	D1 and D2 Switching conditions
0	always inactive
1	always active
2	ready for operation; no malfunction (operating state: ready)
3	ready for operation; control release (terminal X2.1) given; modulation enabled (operating state: run)
4	abnormal operating state or error (status A.xx or E.xx)
5	error (only status E.xx)
6	- reserved -
7	after the motor positive temperature coefficient is triggered
8	- reserved -
9	current controller restricted ¹⁾
10	speed controller restricted ¹⁾
11	any controller restricted ¹⁾
12	acceleration ramp active
13	deceleration ramp active
14	constant run
15	drive runs with constant speed > speed 0
16	forward – not with noP, LS, Abnormal Stopping or error
17	reverse – not with noP, LS, Abnormal Stopping or error

	only digital output D1	only digital output D2
18	- reserved -	actual speed > speed level
19	- reserved -	- reserved -
20	torque > torque level ¹⁾	- reserved -
21	- reserved -	- reserved -
22	- reserved -	- reserved -
23	- reserved -	- reserved -
24	overload prewarning: overload counter > 80 %	
25	overload prewarning: overload counter > 40 %	
26	prewarning: "heat sink temperature"	
27	- reserved -	speed reference displ. > speed level
28	- reserved -	system deviation > speed level ¹⁾
29	overload 2 - prewarning (refer to Instruction Manual Part 2)	
30	- reserved -	
31	- reserved -	
32	- reserved -	
33	Fault signal; Inverter has disabled the modulation after an error or fast stop and automatic restart is not activated for the respective error.	

1) Only during closed-loop operation (CP.32 = 1) !



Hysteresis

of the torque level : 5% of M_N motor adjusted in the factory (see page 23)
of the speed level : 10 rpm

Torque Level output D1

CP.23

Defines the torque level for the digital output D1. During open-loop operation (CP.32 = 0) the value for the motor torque is set at 0.

Adjustment Range:	0...2000	Nm
Resolution:	0,1	Nm
Factory setting:	0	Nm
Customer setting:	_____	Nm

max. Tolerance approx. $\pm 30\%$ in the base speed range
(In the field weakening range larger tolerances are possible, also see reference on page 4)

Speed Level output D2

CP.24

Defines the speed level for the digital output D2.

Adjustment Range:	0...9999,5	rpm
Resolution:	0,5	rpm
Factory setting:	0	rpm
Customer setting:	_____	rpm

Rated Motor Power

CP.25

The rated motor power of the connected motor must be adjusted in CP.25.

Adjustment Range:	0,01...75	kW
Resolution:	0,01	kW
Factory setting:	dependent on size	
Customer setting:	_____	kW

Rated Motor Speed

CP.26

The rated motor speed of the connected motor must be adjusted in CP.26.

Adjustment Range:	100...9999,5	rpm
Resolution:	1	rpm
Factory setting:	dependent on size	
Customer setting:	_____	rpm

Rated Motor Current

CP.27

The rated current of the connected motor must be adjusted in CP.27.

Adjustment Range:	dependent on size	
Resolution:	0,1	A
Factory setting:	dependent on size	
Customer setting:	_____	A

Rated Motor Frequency

CP.28

The rated frequency of the connected motor must be adjusted in CP.28.

Adjustment Range:	20...300	Hz
Resolution:	1	Hz
Factory setting:	dependent on size	
Customer setting:	_____	Hz

Rated Motor cos (Phi)

CP.29

The rated power factor of the connected motor must be adjusted in CP.29.

Adjustment Range:	0,05...1
Resolution:	0,01
Factory setting:	dependent on size
Customer setting:	_____

Rated Motor Voltage

CP.30

The rated voltage of the connected motor must be adjusted in CP.30.

Adjustment Range:	100...500	V
Resolution:	1	V
Factory setting:	400	V
Customer setting:	_____	V

Load motor dependent parameter

CP.31

The basic settings of the inverter correspond to the size of the unit and the respective motor (see table on page GB 35). If the motor data in CP.25...30 are changed, then CP.31 must be activated once. This re-adjusts the current controller, torque curve and torque limit. With this the torque limit is set at the value, that is maximally possible in the speed range (dependent on inverter rated current).

Value Meaning

- | | |
|---|--|
| 1 | Pre-adjustment of the motor-dependent control-parameters
The adjusted voltage stabilization value or the voltage class of the inverter is taken as input voltage. |
| 2 | Pre-adjustment of the motor-dependent control-parameters
The DC-link voltage $\sqrt{2}$ measured at switch on is taken as input voltage. |

The pre-adjustments made at value 1 or 2 refer to the same parameters. For CP.31=2 the inverter measures automatically the input voltage which is required as reference value for the calculation.

Adjustment Range:	0...2
Resolution:	1
Werkseinstellung:	0
Customer setting:	_____



When control release is active the adjustment was not completed. "nco" appears in the display!

Speed Regulation on/off



In CP.32 you can select whether the inverter operates open-loop or closed loop.

Adjustment Range:	0...1
Resolution:	1
Factory setting:	0
Customer setting:	_____

- 0 = open-loop (U/f-curve)
- 1 = closed-loop (field-oriented control)

During open-loop operation the torque limits, levels and displays do not have a function. All parameters, that access these values, either do not have a function or have a restricted function. This is described in the individual parameters.

Caution ! Only switch over when control release is open ! Torque jumps may occur if not observed.

Boost



The voltage increase for the lower speed range is adjusted with the boost, which results in a higher torque in the lower range. **During closed-loop operation this parameter does not have a function!**

Adjustment Range:	0...25,5	%
Resolution:	0,1	%
Factory setting:	2	%
Customer setting:	_____	%

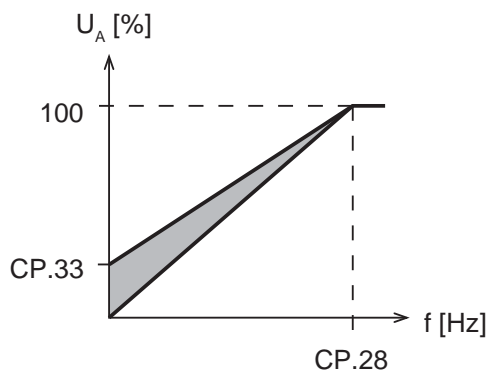

When the motor is driven during continuous operation at a slow speed and the voltage is too high, the motor may overheat!

Change Encoder 1 Rotation

Adjusts the direction of rotation of the encoder.



Adjustment Range: 0...1
 Resolution: 1
 Factory setting: 0
 Customer setting: _____

- 0 = track **not** exchanged
- 1 = track exchanged

Reaction to Limit Switch

This parameter determines the reaction of the drive, to terminal X2.3 (F) and/or X2.4 (R). These terminals can be programmed as software limit switches. The reaction of the drive is shown in the table below.



Adjustment Range: 0...6
 Resolution: 1
 Factory setting: 6
 Customer setting: _____

Value	Error / Status message	Response of the drive
0	E.PrF E.Prr	modulation immediately switched off ! To restart remove error and activate Reset !
1	A.PrF A.Prr	quick stop / modulation switched off after speed 0 is reached ! To restart remove error and activate Reset !
2	A.PrF A.Prr	quick stop / holding torque at speed 0 ! To restart remove error and activate Reset !
3	A.PrF A.Prr	modulation immediately switched off ! Automatic restart , when error is no longer present !
4	A.PrF A.Prr	quick stop / modulation switched off after speed 0 is reached ! Automatic restart , when error is no longer present !
5	A.PrF A.Prr	quick stop / holding torque at speed 0 ! Automatic restart , when error is no longer present !
6	keine	no effect on the drive ! Fault is ignored !



Quick stop



deceleration at the torque limit (CP.9)

Aux Function

CP.36

In CP.36 you can adjust on which parameter the 2nd analog input REF2 should work (X2.16 / X2.17). **During open-loop operation values 2; 3; 4 and 5 do not have a function !**

Adjustment range: 0..6
 Resolution: 1
 Factory setting: 0
 Customer setting: _____

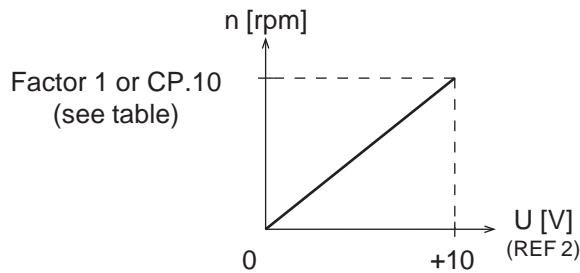

0	no function
1	adds to the setpoint (has no influence on the Jogging operation) 1 0 V = CP.10
2	works as a multiplier for parameter CP.12 (P-factor of the speed controller) 10 V = gain 1
3	works as a multiplier for parameter CP.13 (I-factor of the speed controller) 10 V = gain 1
4	works as a multiplier for parameter CP.12 + CP.13 (total gain of the speed controller) 10 V = gain 1
5	works as a multiplier for parameter CP.9 (torque limit) 10 V = gain 1
6	torque control; only available in the application mode



In the table below the factory settings for the size-dependent parameter values are listed.

Unit size	CP.25 [kW] Rated motor power	CP.26 [rpm] Rated motor speed	CP.27 [A] Rated motor current	CP.28 [Hz] Rated motor frequency	CP.29 cos Phi Rated motor cos (Phi)	CP.30 [V] Rated motor voltage	[Nm] Rated motor torque	CP.9 [Nm] Maximum torque
07	0,55	1400	2,8	50	0,72	230	3,7	10,5
13	4	1435	15,3	50	0,78	230	26,6	68,5
14	5,5	1440	18,5	50	0,89	230	36,4	100,2
15	7,5	1440	26,0	50	0,84	230	49,2	148,9
10	1,5	1400	3,4	50	0,83	400	10,2	32,5
12	3,0	1435	6,7	50	0,79	400	19,9	53,9
13 - E	4	1435	8,8	50	0,78	400	26,6	69,9
13 - G	4	1435	8,8	50	0,78	400	26,6	59,0
14 - E	5,5	1440	10,5	50	0,89	400	36,4	103,5
14 - G	5,5	1440	10,5	50	0,89	400	36,4	88,0
15	7,5	1440	15,0	50	0,84	400	49,7	125,8
16	11	1440	21,5	50	0,85	400	72,9	175,2
17	15	1455	28,5	50	0,86	400	98,5	224,6
18	18,5	1455	35,0	50	0,86	400	121,4	268,4
19	22	1470	42,0	50	0,84	400	142,9	321,5
20	30	1465	55,5	50	0,85	400	195,5	411,4
21	37	1470	67,0	50	0,86	400	240,3	498,3
22	45	1470	81	50	0,86	400	292,3	646,3
23	55	1475	98,5	50	0,86	400	356,0	840,9

Chapter 4	Section 3	Page 24	Date 18.12.02	Name: Basis KEB COMBIVERT F4-F	© KEB Antriebstechnik, 2002 All Rights reserved
---------------------	---------------------	-------------------	------------------	--	--

1. Introduction		
2. Summary		
3. Hardware		
4. Operation	<ul style="list-style-type: none"> 4.1 Fundamentals 4.2 Password Structure 4.3 CP-Parameter 4.4 Drive-Mode 	<ul style="list-style-type: none"> 4.4.1 Adjustment Possibilities 3 4.4.2 Display and Keyboard 3 4.4.3 Setpoint Display / Setpoint Input 3 4.4.4 Rotation Setting 4 4.4.5 Start / Stop / Run 4 4.4.6 Leaving the Drive-Mode 5
5. Parameter		
6. Functions		
7. Start-up		
8. Special Operation		
9. Error Assistance		
10. Project Planning		
11. Networks		
12. Applications		
13. Annex		

4.4 Drive-Mode

The Drive-Mode is a special operating mode of the KEB COMBIVERT. It allows an easy manual start-up. To activate the Drive-Mode enter the password „500“ in ‘CP.0’ or ‘ud.0’. Following settings are possible:

4.4.1 Adjustment Possibilities

- Stop / Start / Run
- Setpoint value
- Direction of rotation

All other settings like setpoint limitation, acceleration time, deceleration time etc. correspond to the preselection in the parameter sets.

! Hardware condition: The control release must be bridged!

4.4.2 Display and Keyboard

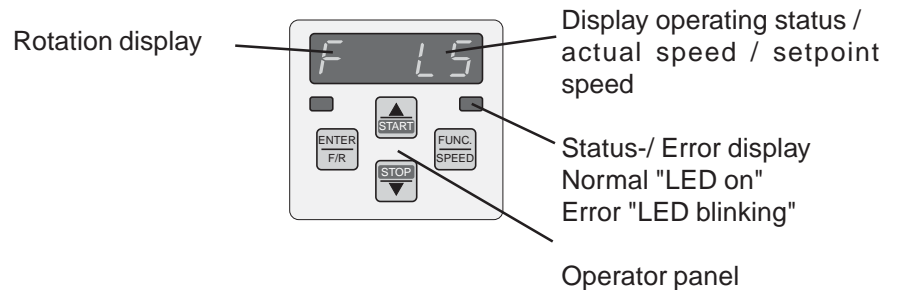

4.4.3 Setpoint Display / Setpoint Input

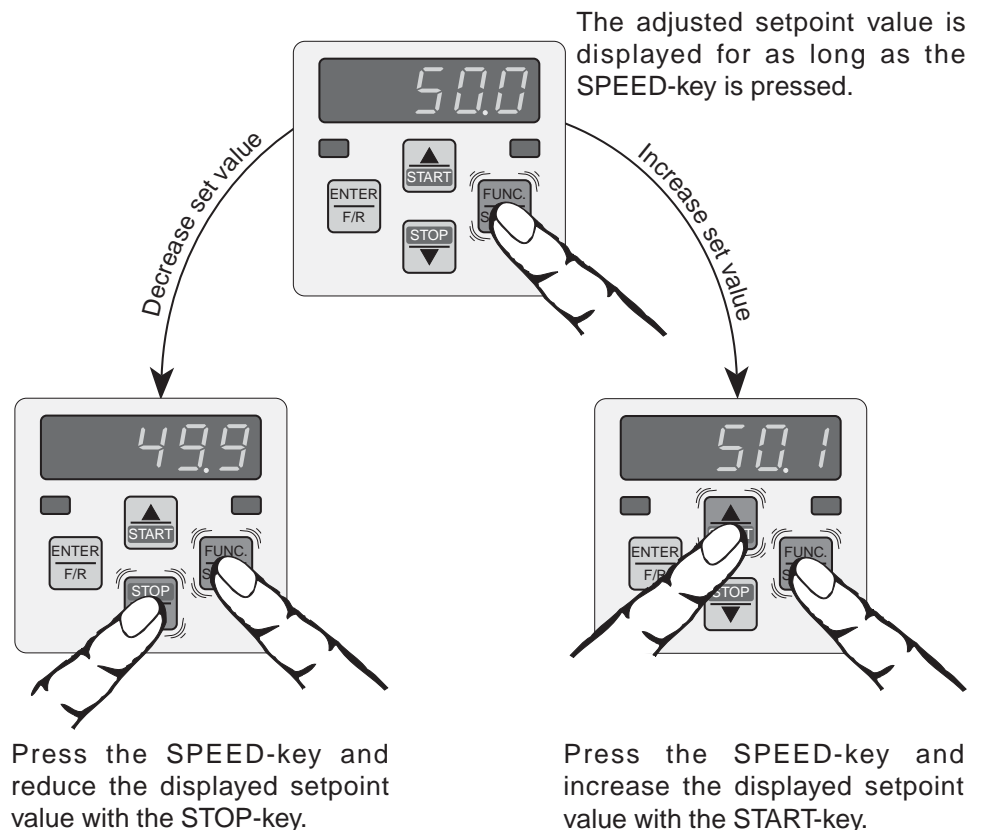

4.4.4 Rotation Setting

Setting possibilities:

F = forward (clockwise rotation)

r = reverse (counter-clockwise rotation)

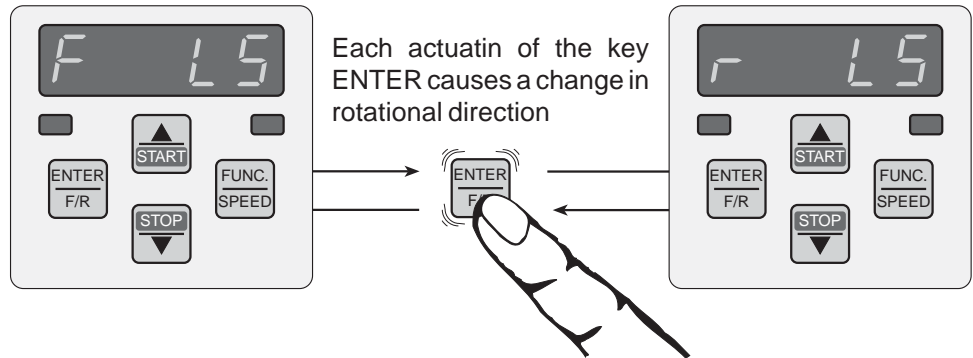

4.4.5 Start / Stop / Run

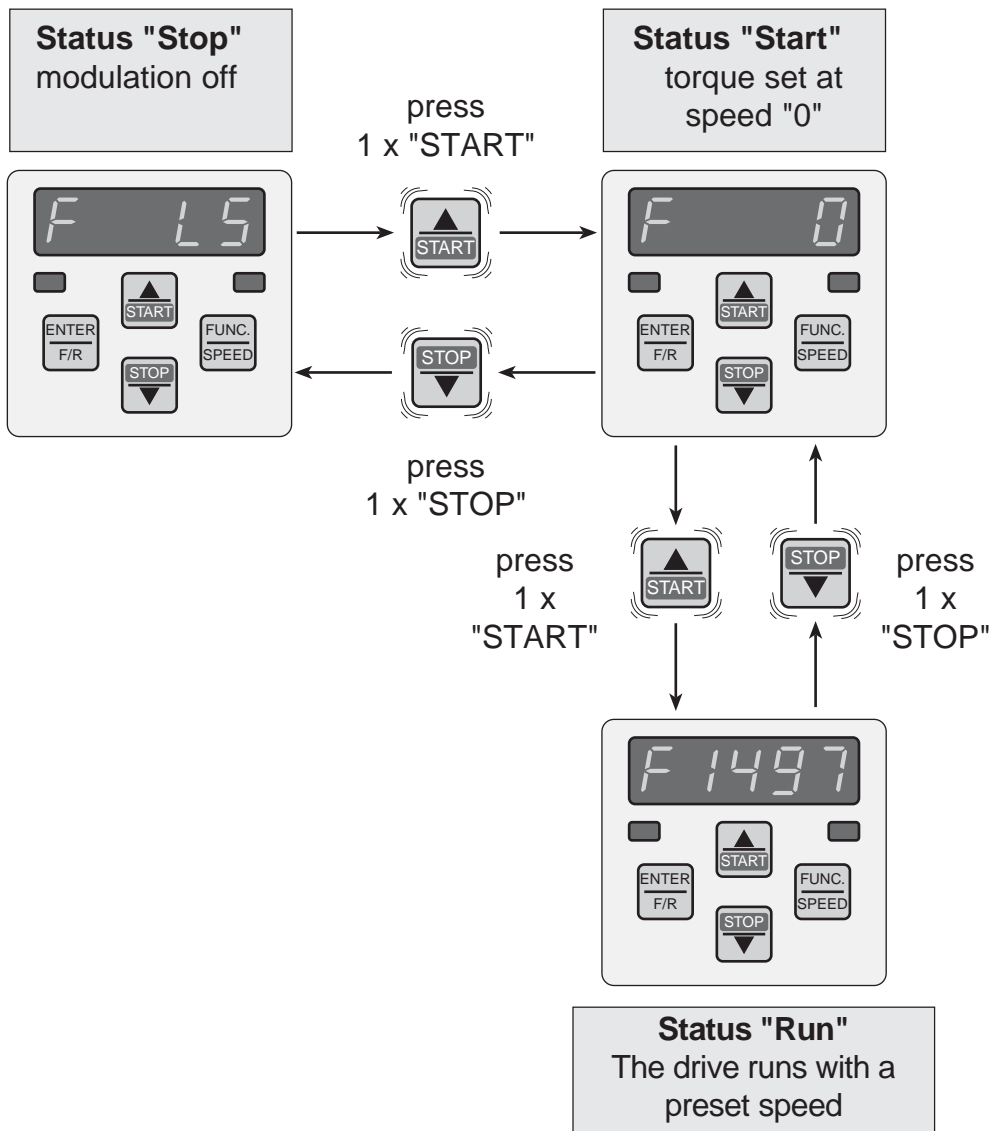

4.4.6 Leaving the Drive-Mode

To leave the Drive-Mode, the keys „FUNC“ and „ENTER“ must be pressed simultaneously for approx. 3 seconds while being in **status „Stop“**! The unit jumps back into the mode from where the Drive-Mode was started.

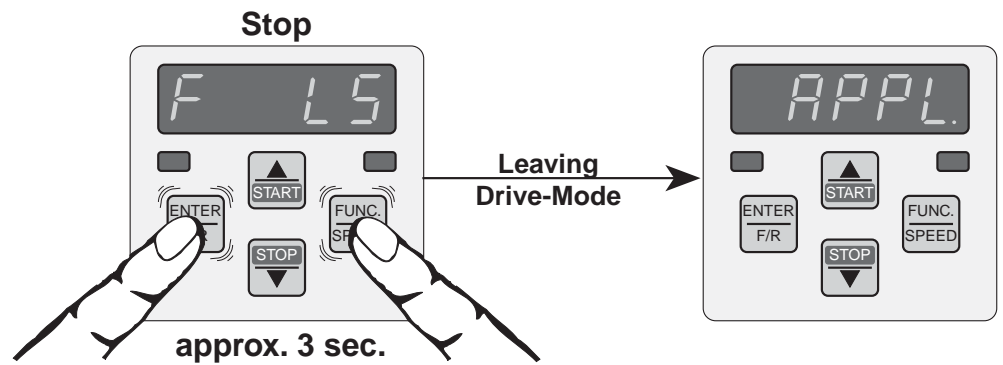

1. Introduction

2. Summary

3. Hardware

4. Operation

5. Parameter

6. Functions

7. Start-up

8. Special Operation

9. Error Assistance

10. Project Planning

11. Networks

12. Applications

13. Annex

5.1 Parameter

5.1.1 Parameter Groups 3
5.1.2 Parameter Listing F4-F 5

5. Parameter

The frequency inverter KEB COMBIVERT F4-C contains 14 fixed and one free-to-define parameter group. We have already learned about the free-to-define group (CP). In the fixed parameter groups the parameters are combined function-related.

5.1 Parameter

5.1.1 Parameter Groups

Pic. 5.1.1 Parameter structure

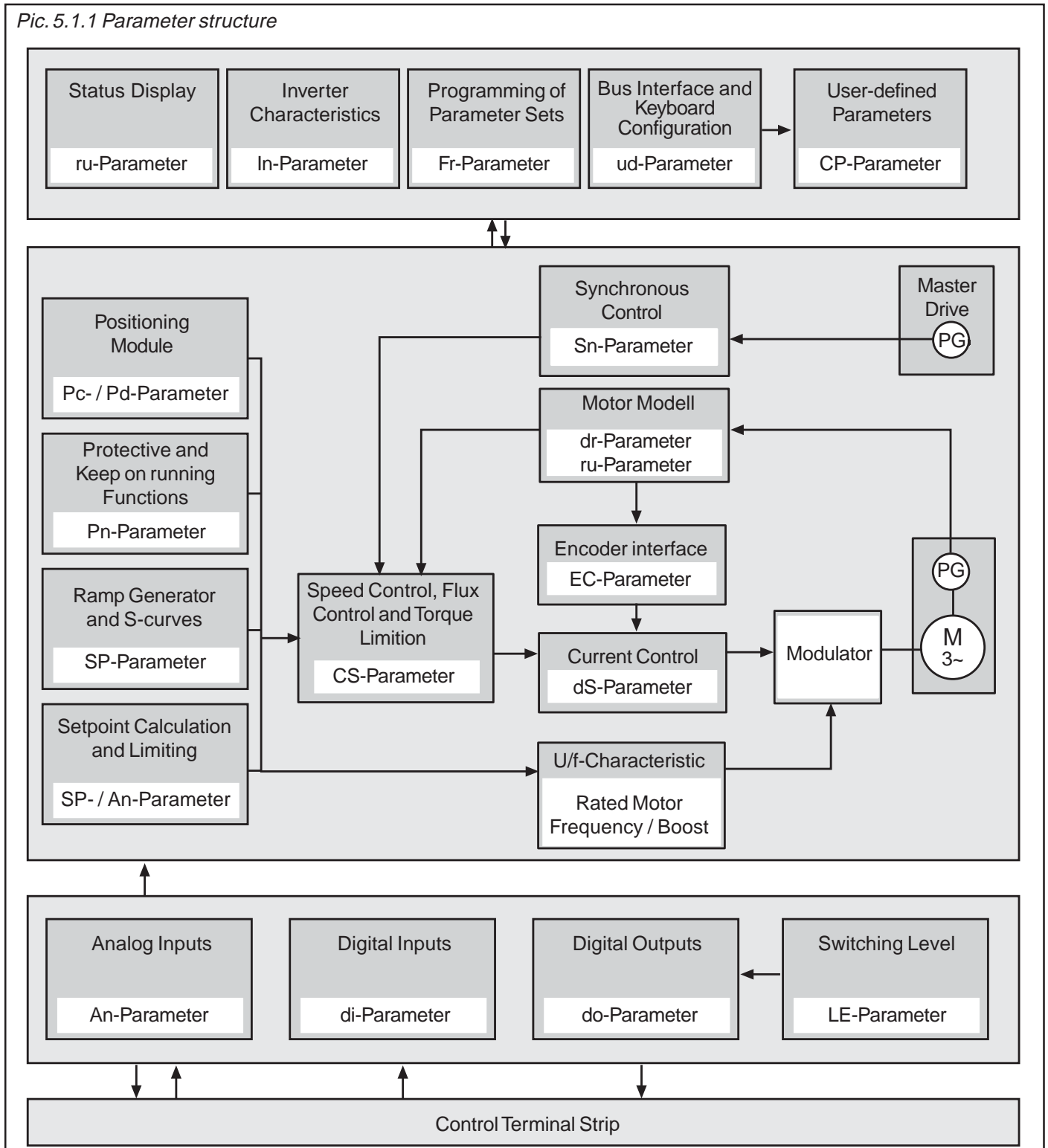

5

5.1.2 Parameterlisting F4-F

ru - Parameter	Addr.								[?]	see Page(s)
Parameter group	Parameter address	Parameter: ✓ set programmable - not programmable	Enter parameter: ✓ active after „Enter“ - active immediately	Parameter: ✓ writable - readable only	Value range Lower limit / Upper limit	Resolution	Default value	Unit	Description	
ru 0 inverter state	2000	-	-	-	0	111	table	—	—	6.1.5, 6.12.4
ru 1 actual speed display	2001	-	-	-	-14000	14000	0,5	—	rpm	6.1.8, 6.5.5
ru 2 actual torque display	2002	-	-	-	0,0	1000,0	0,1	—	Nm	6.1.8, 6.5.5
ru 4 set speed display	2004	-	-	-	-14000	14000	0,5	—	rpm	6.1.8, 6.5.5
ru 7 actual inverter utilization	2007	-	-	-	0	200	1	—	%	6.1.9, 6.3.11
ru 8 peak inverter utilization	2008	-	-	✓	0	200	1	—	%	6.1.9
ru 9 apparent current	2009	-	-	-	0	*)	0,1	—	A	6.1.9
ru 10 active current	200A	-	-	-	0	*)	0,1	—	A	6.1.9, 6.3.11, 6.5.5
ru 11 actual DC voltage	200B	-	-	-	200	999	1	—	V	6.1.9
ru 12 peak DC voltage	200C	-	-	✓	200	999	1	—	V	6.1.10
ru 14 input terminal state	200E	-	-	-	0	127	1	—	—	6.1.10, 6.3.4
ru 15 output terminal state	200F	-	-	-	0	247	1	—	—	6.1.10, 6.3.15
ru 16 internal input state	2010	-	-	-	0	3967	1	—	—	6.1.11, 6.3.8
ru 17 internal output state	2011	-	-	-	0	255	1	—	—	6.1.11
ru 18 actual parameter set	2012	-	-	-	0	7	1	—	—	6.1.12
ru 20 speed REF display	2014	-	-	-	-14000	14000	0,5	—	rpm	6.1.12
ru 22 REF 1 display	2016	-	-	-	-100,0	100,0	0,1	—	%	6.1.12
ru 23 REF 2 display	2017	-	-	-	-100,0	100,0	0,1	—	%	6.1.12
ru 24 OL counter display	2018	-	-	-	0	100	1	—	%	6.1.12
ru 25 peak apparent current	2019	-	-	✓	0	*)	0,1	—	A	6.1.13
ru 26 actual speed master	201A	-	-	-	-14000	14000	0,5	—	rpm	6.1.13
ru 27 angular deviation	201B	-	-	-	-360,0	360,0	0,1	—	°	6.1.13
ru 28 speed deviation	201C	-	-	-	-14000	14000	0,5	—	rpm	6.1.13
ru 29 heat sink temperature	201D	-	-	-	0	100	1	—	°C	6.1.13
ru 31 power on counter	201F	-	-	-	0	65535	1	—	h	6.1.14
ru 32 modulation on counter	2020	-	-	-	0	65535	1	—	h	6.1.14
ru 35 actual position sign	2023	-	-	-	0	1	1	—	inc	6.1.14, 6.11.4
ru 36 actual position high	2024	-	-	-	0	65535	1	—	inc	6.1.14, 6.11.4
ru 37 actual position low	2025	-	-	-	0	65535	1	—	inc	6.1.15, 6.11.4
ru 38 set position sign	2026	-	-	-	0	1	1	—	inc	6.1.15, 6.11.4
ru 39 set position high	2027	-	-	-	0	65535	1	—	inc	6.1.15, 6.11.4
ru 40 set position low	2028	-	-	-	0	65535	1	—	inc	6.1.15, 6.11.4
ru 58 latch-position sign	203A	-	-	✓	-	-	1	—	-	6.1.16
ru 59 latch-position high	203A	-	-	✓	-	-	1	—	-	6.1.16
ru 60 latch-position low	203A	-	-	✓	-	-	1	—	-	6.1.16
SP - Parameter	Addr.								[?]	see Page(s)
SP 0 speed setting source	3000	✓	✓	✓	0	18	1	2	—	6.4.6
SP 1 speed setting absolut	3001	✓	-	✓	-14000	14000	0,5	0,0	rpm	6.4.5
SP 2 speed setting %	3002	✓	-	✓	-100,0	100,0	0,1	0,0	%	6.4.5
SP 3 rotation setting	3003	✓	✓	✓	0	2	1	0	—	6.4.6
SP 4 minimal speed reference forward	3004	✓	-	✓	0,0	14000	0,5	0,0	rpm	6.4.7
SP 5 maximal speed reference forward	3005	✓	-	✓	0,0	14000	0,5	2100,0	rpm	6.4.7
SP 6 minimal speed reference reverse	3006	✓	-	✓	0,0	14000	0,5	-1 : off	rpm	6.4.7
SP 7 maximal speed reference reverse	3007	✓	-	✓	0,0	14000	0,5	-1 : off	rpm	6.4.7
SP 8 absolute maximum speed forward	3008	-	-	✓	0,0	14000	0,5	6000,0	rpm	6.4.7
SP 9 absolute maximum speed reverse	3009	-	-	✓	0,0	14000	0,5	-1 : off	rpm	6.4.7
SP 10 speeddifference accelearat/decelerat.	300A	✓	-	-	0,0	14000	0,5	1000	rpm	6.4.10
SP 11 acceleration time forward	300B	✓	-	✓	0,00	320,00	0,01	2,00	sec	6.4.10
SP 12 deceleration time forward	300C	✓	-	✓	0,00	320,00	0,01	2,00	sec	6.4.10
SP 13 acceleration time reverse	300D	✓	-	✓	0,00	320,00	0,01	-1 : off	sec	6.4.10
SP 14 deceleration time reverse	300E	✓	-	✓	0,00	320,00	0,01	-1 : off	sec	6.4.10
SP 15 s-curve accelerate forward	300F	✓	-	✓	0,00	5,00	0,01	0,00	sec	6.4.12
SP 16 s-curve decelerate forward	3010	✓	-	✓	0,00	5,00	0,01	-1 : off	sec	6.4.12
SP 17 s-curve accelerate reverse	3011	✓	-	✓	0,00	320,00	0,01	-1 : off	sec	6.4.12
SP 18 s-curve decelerate reverse	3012	✓	-	✓	0,00	5,00	0,01	-1 : off	sec	6.4.12
SP 22 jogging speed	3016	-	-	✓	0,0	14000	0,5	100,0	rpm	4.3.4, 4.3.10
SP 26 motorpoti function	301A	-	-	✓	0	15	1	0	—	6.8.12
SP 27 motorpoti time	301B	-	-	✓	0,00	300,00	0,01	128,00	sec	6.8.12

*) dependent by the inverter size

Parameter

Pn - Parameter	Addr.							[?]	see Page(s)	
Pn 0 automatic retry UP	2200	-	-	✓	0	1	1	0	—	6.6.6
Pn 1 automatic retry OP	2201	-	-	✓	0	1	1	0	—	6.6.6
Pn 3 electronic motor protection	2203	-	-	-	0	4	1	0	—	6.6.3
Pn 7 speed search condition	2207	✓	-	✓	0	15	1	8	—	6.6.5, 6.6.6
Pn 16 E.dOH delay time	2210	-	-	✓	0	120	1	0	sec	6.3.10, 6.6.3, 6.6.4
Pn 17 power off start voltage	2211	-	✓	✓	198	800	1	198	—	6.8.13
Pn 20 extern fault stopping condition	2214	-	✓	✓	0	6	1	0	—	6.6.4
Pn 23 E.bus stopping condition	2217	-	✓	✓	0	6	1	6	—	11.2.3
Pn 24 prohibited rotation stopping condition	2218	-	✓	✓	0	6	1	6	—	6.11.7
Pn 25 warning dOH stopping condition	2219	-	✓	✓	0	6	1	6	—	6.6.3
Pn 26 warning OH stopping condition	221A	-	✓	✓	0	6	1	6	—	6.6.3
Pn 33 power off mode	2221	-	✓	✓	1	2	1	2	—	6.8.13
Pn 60 torque for abnormal stop	223C	-	✓	✓	0,0	5 x dr.09	0,1	?	Nm	6.8.13
Pn 63 emergency-stop-ramp	223F	-	-	-	0	10	0,01	0	sec	6.6.7
dr - Parameter	Addr.							[?]	see Page(s)	
dr 0 rated motor power	2400	-	✓	✓	0,01	327,67	0,01	*)	kW	6.5.3
dr 1 rated motor speed	2401	-	✓	✓	100	9999	1	*)	rpm	6.5.3
dr 2 rated motor current	2402	-	✓	✓	0,1	1000	0,1	*)	A	6.5.3
dr 3 rated motor frequency	2403	-	✓	✓	20	500	1	50	Hz	6.5.3, 6.5.5
dr 4 rated motor cos (phi)	2404	-	✓	✓	0,05	1,00	0,01	*)	—	6.5.3
dr 9 rated motor torque	2409	-	-	-	0,1	500,0	0,1	—	Nm	6.5.11
dr 10 maximum torque	240A	-	-	-	0,1	Inv. max.	0,1	—	Nm	6.5.5, 6.5.11
dr 12 rated motor voltage	240C	-	✓	✓	100	500	1	400	V	6.5.3, 6.5.5
dr 13 speed for maximum torque	240D	-	✓	✓	0,0	14000	0,5	1000,0	rpm	6.5.5, 6.5.11
dr 16 maximum torque corner speed	2410	-	✓	✓	0,0	5 x dr.09	0,1	1,5 x dr.09 *)	Nm	6.5.5, 6.5.11
dr 19 corner speed field weakening	2413	-	✓	✓	200,0	14000	0,5	1300,0	rpm	6.5.6, 6.5.12
dr 20 field weakening curve	2414	-	✓	✓	0,10	2,00	0,01	1,20	—	6.5.12
dr 21 flux adaption factor	2415	-	✓	✓	25	250	1	100	%	6.5.12
dr 48 rotor resistance	2430	-	✓	-	0,001	32,767	0,001	1,100	Ohm	6.5.7
dr 49 magnetic inductance	2431	-	✓	-	10,0	3276,7	0,1	146	mH	6.5.7
dr 50 stator resistance	2432	-	✓	✓	0,000	32,767	0,001	1,100	Ohm	6.5.13
dr 51 leakage reactance	2433	-	✓	✓	0,00	327,67	0,01	10,58	mH	6.5.13
dr 52 motor connection	2434	-	✓	✓	0	1	1	1	—	6.5.13
CS - Parameter	Addr.							[?]	see Page(s)	
CS 0 KP speed	2D00	✓	-	✓	0	32767	1	400	—	6.5.10
CS 1 KI speed	2D01	✓	-	✓	0	32767	1	200	—	6.5.10
CS 3 KP speed gain	2D03	-	-	✓	0	32767	1	0	—	6.5.10
CS 4 KP speed limit	2D04	-	-	✓	0	32767	1	0	—	6.5.10
CS 6 torque limit forward positive	2D06	✓	-	✓	0,0	5 x dr.9	0,1	dr.10	Nm	6.5.11
CS 7 torque limit reverse positive	2D07	✓	-	✓	-0,1 : off	5 x dr.9	0,1	-0,1 : off	Nm	6.5.11
CS 8 torque limit forward negative	2D08	✓	-	✓	-0,1 : off	5 x dr.9	0,1	-0,1 : off	Nm	6.5.11
CS 9 torque limit reverse negative	2D09	✓	-	✓	-0,1 : off	5 x dr.9	0,1	-0,1 : off	Nm	6.5.11
CS 10 aktivation of adaptation	2D0A	-	-	✓	0	65535	1	0	—	6.5.13
CS 11 KI offset	2D0B	-	-	✓	0	65535	1	0	—	6.5.10
CS 12 max speed for max Ki	2D0C	-	-	✓	0,0	14000	0,5	10,0	rpm	6.5.10
CS 13 min. speed for Cs.01	2D0D	-	-	✓	0,0	14000	0,5	500,0	rpm	6.5.10
CS 14 standstill position control	2D0E	-	-	✓	0	65535	1	0	—	6.5.10
CS 19 KP flux	2D13	-	-	✓	0 : off	65535	1	0 : off	—	6.5.12
CS 20 KI flux	2D14	-	-	✓	1	65535	1	1	—	6.5.12
CS 21 magn. current limit	2D15	-	-	✓	0,0	ln.1	0,1	0,0	A	6.5.12
CS 22 flux mode	2D16	-	✓	✓	0	1	1	0	—	6.5.13
CS 23 speed regulation active	2D17	✓	✓	✓	0 : off	1	1	0 : off	—	6.5.5
CS 39 KP U-max	2D27	-	-	✓	0	65535	1	0	—	6.5.13
CS 40 PT1-time U-max	2D28	-	-	-	0	5000	0	100	ms	6.5.13
ds - Parameter	Addr.							[?]	see Page(s)	
ds 0 KP I active	2F00	-	-	✓	1	65535	1	1500	—	6.5.9
ds 1 KI I active	2F01	-	-	✓	1	65535	1	500	—	6.5.9
ds 5 KP I magnetizing	2F05	-	-	✓	0	65535	1	-1 : off	—	6.5.9
ds 6 KI I magnetizing	2F06	-	-	✓	0	65535	1	-1 : off	—	6.5.9
ds 9 no load voltage	2F09	-	-	✓	0,0	100,0	0,1	75,0	%	6.5.9
ds 10 DC voltage compensation	2F0A	-	✓	✓	180	500	1	501 : off	V	6.5.6
ds 11 boost	2F0B	-	-	✓	0,0	25,5	0,1	2,0	%	6.5.6
ds 12 modulation depth	2F0C	-	-	-	0	100	1	—	%	6.5.8
ds 13 carrier frequency	2F0D	-	✓	✓	0	1	1	0	—	6.5.8
ds 14 overmodulation	2F0E	-	✓	✓	0	1	1	1	—	6.5.8
dS 15 Adaption factor	2F0F	-	-	-	0,0 : off	100,0	0,1	-	%	6.5.14
ds 16 dead time compensation	2D10	-	-	-	0 : off	1 : on	1	0 : off	—	—
ds 17 waiting for magnetisation current	2D11	-	-	-	0 : off	1 : on	1	0 : off	—	6.5.8
ds 18 eqv circuit identification	2D12	-	-	-	0	9999	1	0	—	6.5.6

*) dependent by the inverter size

ud - Parameter	Addr.								[?]	see Page(s)
ud 0 key password input	2600	-	✓	✓	0	9999	1	cp_on	—	4.4.3
ud 1 bus password input	2601	-	-	✓	-32767	32767	1	cp_on	—	6.12.5
ud 2 start parameter group	2602	-	-	✓	1 : ru	16 : Pd	1	1 : ru	—	6.12.4
ud 3 start parameter number	2603	-	-	✓	0	255	1	1	—	6.12.4
ud 6 inverter address	2606	-	✓	✓	0	239	1	1	—	11.2.3
ud 7 baud rate	2607	-	✓	✓	1200	57600	table	9600	Baud	11.2.3
ud 8 watchdog time	2608	-	✓	✓	0 : off	10,00	0,01	0 : off	sec	11.2.3
ud 13 CP0 address	260D	-	-	-	—	—	1	—	—	6.12.5
ud 14 CP0 set definition	260E	-	-	-	—	—	1	—	—	6.12.5
ud 15 CP1 address	260F	-	✓	✓	-1 : off	7FFF	1	2001 (ru. 1)	—	6.12.4
ud 16 CP1 set definition	2610	-	✓	✓	0	8 (A)	1	0	—	6.12.4
ud 17 CP2 address	2611	-	✓	✓	-1 : off	7FFF	1	2000 (ru. 0)	—	6.12.4
ud 18 CP2 set definition	2612	-	✓	✓	0	8 (A)	1	0	—	6.12.4
ud 19 CP3 address	2613	-	✓	✓	0	7FFF	1	2009 (ru. 9)	—	6.12.4
ud 20 CP3 set definition	2614	-	✓	✓	0	8 (A)	1	0	—	6.12.4
ud 21 CP4 address	2615	-	✓	✓	0	7FFF	1	2019 (ru.25)	—	6.12.4
ud 22 CP4 set definition	2616	-	✓	✓	0	8 (A)	1	0	—	6.12.4
ud 23 CP5 address	2617	-	✓	✓	0	7FFF	1	2002 (ru. 2)	—	6.12.4
ud 24 CP5 set definition	2618	-	✓	✓	0	8 (A)	1	0	—	6.12.4
ud 25 CP6 address	2619	-	✓	✓	0	7FFF	1	2004 (ru. 4)	—	6.12.4
ud 26 CP6 set definition	261A	-	✓	✓	0	8 (A)	1	0	—	6.12.4
ud 27 CP7 address	261B	-	✓	✓	0	7FFF	1	300B (sP.11)	—	6.12.4
ud 28 CP7 set definition	261C	-	✓	✓	0	8 (A)	1	0	—	6.12.4
ud 29 CP8 address	261D	-	✓	✓	0	7FFF	1	300C (sP.12)	—	6.12.4
ud 30 CP8 set definition	261E	-	✓	✓	0	8 (A)	1	0	—	6.12.4
ud 31 CP9 address	261F	-	✓	✓	0	7FFF	1	2D06 (Cs. 6)	—	6.12.4
ud 32 CP9 set definition	2620	-	✓	✓	0	8 (A)	1	0	—	6.12.4
ud 33 CP10 address	2621	-	✓	✓	0	7FFF	1	3005 (sP. 5)	—	6.12.4
ud 34 CP10 set definition	2622	-	✓	✓	0	8 (A)	1	0	—	6.12.4
ud 35 CP11 address	2623	-	✓	✓	0	7FFF	1	3016 (sP.22)	—	6.12.4
ud 36 CP11 set definition	2624	-	✓	✓	0	8 (A)	1	0	—	6.12.4
ud 37 CP12 address	2625	-	✓	✓	0	7FFF	1	2D00 (Cs. 0)	—	6.12.4
ud 38 CP12 set definition	2626	-	✓	✓	0	8 (A)	1	0	—	6.12.4
ud 39 CP13 address	2627	-	✓	✓	0	7FFF	1	2D01 (Cs. 1)	—	6.12.4
ud 40 CP13 set definition	2628	-	✓	✓	0	8 (A)	1	0	—	6.12.4
ud 41 CP14 address	2629	-	✓	✓	0	7FFF	1	2419 (dr.25)	—	6.12.4
ud 42 CP14 set definition	262A	-	✓	✓	0	8 (A)	1	0	—	6.12.4
ud 43 CP15 address	262B	-	✓	✓	0	7FFF	1	2214 (Pn.20)	—	6.12.4
ud 44 CP15 set definition	262C	-	✓	✓	0	8 (A)	1	0	—	6.12.4
ud 45 CP16 address	262D	-	✓	✓	0	7FFF	1	2804 (An.4)	—	6.12.4
ud 46 CP16 set definition	262E	-	✓	✓	0	8 (A)	1	0	—	6.12.4
ud 47 CP17 address	262F	-	✓	✓	0	7FFF	1	2802 (An. 2)	—	6.12.4
ud 48 CP17 set definition	2630	-	✓	✓	0	8 (A)	1	0	—	6.12.4
ud 49 CP18 address	2631	-	✓	✓	0	7FFF	1	280E (An.14)	—	6.12.4
ud 50 CP18 set definition	2632	-	✓	✓	0	8 (A)	1	0	—	6.12.4
ud 51 CP19 address	2633	-	✓	✓	0	7FFF	1	280F (An.15)	—	6.12.4
ud 52 CP19 set definition	2634	-	✓	✓	0	8 (A)	1	0	—	6.12.4
ud 53 CP20 address	2635	-	✓	✓	0	7FFF	1	2813 (An.19)	—	6.12.4
ud 54 CP20 set definition	2636	-	✓	✓	0	8 (A)	1	0	—	6.12.4
ud 55 CP21 address	2637	-	✓	✓	0	7FFF	1	2A01 (do. 1)	—	6.12.4
ud 56 CP21 set definition	2638	-	✓	✓	0	8 (A)	1	0	—	6.12.4
ud 57 CP22 address	2639	-	✓	✓	0	7FFF	1	2A02 (do. 2)	—	6.12.4
ud 58 CP22 set definition	263A	-	✓	✓	0	8 (A)	1	0	—	6.12.4
ud 59 CP23 address	263B	-	✓	✓	0	7FFF	1	2B14 (LE.20)	—	6.12.4
ud 60 CP23 set definition	263C	-	✓	✓	0	8 (A)	1	0	—	6.12.4
ud 61 CP24 address	263D	-	✓	✓	0	7FFF	1	2B05 (LE. 5)	—	6.12.4
ud 62 CP24 set definition	263E	-	✓	✓	0	8 (A)	1	0	—	6.12.4
ud 63 CP25 address	263F	-	✓	✓	0	7FFF	1	2400 (dr. 0)	—	6.12.4
ud 64 CP25 set definition	2640	-	✓	✓	0	8 : A	1	0	—	6.12.4
ud 65 CP26 address	2641	-	✓	✓	0	7FFF	1	2401 (dr. 1)	—	6.12.4
ud 66 CP26 set definition	2642	-	✓	✓	0	8 : A	1	0	—	6.12.4
ud 67 CP27 address	2643	-	✓	✓	0	7FFF	1	2402 (dr. 2)	—	6.12.4
ud 68 CP27 set definition	2644	-	✓	✓	0	8 : A	1	0	—	6.12.4
ud 69 CP28 address	2645	-	✓	✓	0	7FFF	1	2403 (dr. 3)	—	6.12.4
ud 70 CP28 set definition	2646	-	✓	✓	0	8 : A	1	0	—	6.12.4
ud 71 CP29 address	2647	-	✓	✓	0	7FFF	1	2404 (dr. 4)	—	6.12.4
ud 72 CP29 set definition	2648	-	✓	✓	0	8 : A	1	0	—	6.12.4
ud 73 CP30 address	2649	-	✓	✓	0	7FFF	1	240C (dr.12)	—	6.12.4
ud 74 CP30 set definition	264A	-	✓	✓	0	8 : A	1	0	—	6.12.4
ud 75 CP31 address	264B	-	✓	✓	0	7FFF	1	270A (Fr.10)	—	6.12.4
ud 76 CP31 set definition	264C	-	✓	✓	0	8 : A	1	0	—	6.12.4
ud 77 CP32 address	264D	-	✓	✓	0	7FFF	1	2D17 (Cs.23)	—	6.12.4
ud 78 CP32 set definition	264E	-	✓	✓	0	8 : A	1	0	—	6.12.4
ud 79 CP33 address	264F	-	✓	✓	0	7FFF	1	2F0B (ds.11)	—	6.12.4
ud 80 CP33 set definition	2650	-	✓	✓	0	8 : A	1	0	—	6.12.4

*) dependent by the inverter size

Parameter

ud 81	CP34 address	2651	-	✓	✓	0	7FFF	1	241D (dr.29)	—	6.12.4
ud 82	CP34 set definition	2652	-	✓	✓	0	8 : A	1	0	—	6.12.4
ud 83	CP35 address	2653	-	✓	✓	0	7FFF	1	2218 (Pn.24)	—	6.12.4
ud 84	CP35 set definition	2654	-	✓	✓	0	8 : A	1	0	—	6.12.4
ud 85	CP36 address	2655	-	✓	✓	0	7FFF	1	280D (An.13)	—	6.12.4
ud 86	CP36 set definition	2656	-	✓	✓	0	8 : A	1	0	—	6.12.4
ud 92	position display mode	265C	-	✓	✓	0 : off	1 : on	1	0	—	
Fr - Parameter		Addr.								[?]	see Page(s)
Fr 0	copy parameter set (key)	2700	✓	✓	✓	-2 : init	7	1	0	—	6.7.3, 6.12.3
Fr 2	parameter set source	2702	-	✓	✓	0	3	1	0	—	6.7.5
Fr 3	parameter set lock	2703	-	✓	✓	0	255	1	0	—	6.7.6
Fr 4	parameter set setting	2704	-	✓	✓	0	7	1	0	—	6.7.5
Fr 5	parameter set activation delay	2705	✓	-	✓	0,000	10,000	0,001	0,000	sec	6.7.7
Fr 6	parameter set deactivation delay	2706	✓	-	✓	0,000	10,000	0,001	0,000	sec	6.7.7
Fr 9	bus parameter set	2709	-	-	✓	-1	7	1	0	—	6.7.3, 6.7.4
Fr 10	load motor dependent parameter	270A	-	✓	✓	0	2	1	0	—	6.5.4
An - Parameter		Addr.								[?]	see Page(s)
An 0	measured value hysteresis	2800	-	-	-	0,00	10,00	0,01	0,00	%	6.2.6
An 1	noise filter REF	2801	-	-	✓	0	10	1	3 (1ms)	—	6.2.6
An 2	zero clamp REF 1	2802	-	-	✓	0,0	10,0	0,1	0,2	%	6.2.9
An 3	REF 1 gain	2803	-	-	✓	-20,00	20,00	0,01	1,00	—	6.2.6
An 4	REF 1 offset X	2804	-	-	✓	-100,0	100,0	0,1	0,0	%	6.2.6
An 5	REF 1 offset Y	2805	-	-	✓	-100,0	100,0	0,1	0,0	%	6.2.6
An 8	zero clamp REF 2	2808	-	-	✓	0,0	10,0	0,1	0,2	%	6.2.9
An 9	REF 2 gain	2809	-	-	✓	-20,00	20,00	0,01	1,00	—	6.2.6
An 10	REF 2 offset X	280A	-	-	✓	-100,0	100,0	0,1	0,0	%	6.2.6
An 11	REF 2 offset Y	280B	-	-	✓	-100,0	100,0	0,1	0,0	%	6.2.6
An 12	REF 1 ↔ REF 2	280C	✓	-	-	0	1	1	0	—	6.2.7
An 13	REF 2 input function	280D	-	✓	-	0	9	1	0	—	6.4.5, 6.4.9, 6.8.9
An 14	analog out1 function	280E	✓	✓	✓	0	6	1	2	—	6.2.10
An 15	analog out1 gain	280F	✓	-	✓	-20	20	0,01	1,00	—	6.2.11
An 16	analog out1 offset X	2810	✓	-	✓	-100,0	100,0	0,1	0,0	%	6.2.11
An 18	analog out2 function	2812	✓	✓	✓	0	6	1	0	—	6.2.10
An 19	analog out2 gain	2813	✓	-	✓	-20,00	20,00	0,01	1,00	—	6.2.11
An 20	analog out2 offset X	2814	✓	-	✓	-100,0	100,0	0,1	0,0	%	6.2.11
di - Parameter		Addr.								[?]	see Page(s)
di 0	noise filter digital	2900	-	-	✓	0,0	20,0	0,1	0,5	ms	6.3.5
di 1	NPN/PNP selection	2901	-	✓	✓	0 : pnp	1 : npn	1	0 : pnp	—	6.3.3
di 2	input logic	2902	-	✓	✓	0	127	1	0	—	6.3.5
di 3	input function I1	2903	-	✓	✓	0	22	1	4	—	6.3.7, 6.1.4, 6.11.10
di 4	input function I2	2904	-	✓	✓	0	22	1	5	—	6.3.7, 6.1.4, 6.11.10
di 5	input function I3	2905	-	✓	✓	0	22	1	3	—	6.3.7, 6.1.4, 6.11.10
di 6	input function I4	2906	-	✓	✓	0	22	1	15	—	6.3.7, 6.1.4, 6.11.10
di 7	input function IA	2907	-	✓	✓	0	22	1	0	—	6.3.7
di 8	input function IB	2908	-	✓	✓	0	22	1	0	—	6.3.7
di 9	input function IC	2909	-	✓	✓	0	22	1	0	—	6.3.7
di 10	input function ID	290A	-	✓	✓	0	22	1	0	—	6.3.7
di 11	input function I5	290B	-	✓	✓	0	22	1	16	—	6.10.4, 6.11.10
di 12	input function I6	290C	-	✓	✓	0	22	1	17	—	6.10.4, 6.11.10
di 15	select signal source	290F	-	✓	✓	0	127	1	0	—	6.3.4
di 16	digital input setting	2910	-	✓	✓	0	127	1	0	—	6.3.4
di 17	input strobe dependance	2911	-	✓	✓	0	4095	1	0	—	6.3.5
di 18	select strobe source	2912	-	✓	✓	0	4095	1	0	—	6.3.5
di 19	select strobe mode	2913	-	✓	✓	0	1	1	0	—	6.3.5
do - Parameter		Addr.								[?]	see Page(s)
do 0	output logic	2A00	✓	✓	✓	0	255	1	0	—	6.3.15
do 1	output condition 1	2A01	✓	✓	✓	0	35	1	20	—	6.3.10
do 2	output condition 2	2A02	✓	✓	✓	0	35	1	18	—	6.3.10
do 3	output condition 3	2A03	✓	✓	✓	0	35	1	2	—	6.3.10
do 4	output condition 4	2A04	✓	✓	✓	0	35	1	0	—	6.3.10
do 5	output condition 5	2A05	✓	✓	✓	0	35	1	0	—	6.3.10
do 6	output condition 6	2A06	✓	✓	✓	0	35	1	0	—	6.3.10
do 7	output condition 7	2A07	✓	✓	✓	0	35	1	0	—	6.3.10
do 8	output condition 8	2A08	✓	✓	✓	0	35	1	0	—	6.3.10
do 9	select out 1 condition	2A09	✓	✓	✓	0	255	1	1	—	6.3.14
do 10	select out 2 condition	2A0A	✓	✓	✓	0	255	1	2	—	6.3.14
do 11	select out 3 condition	2A0B	✓	✓	✓	0	255	1	4	—	6.3.14
do 13	select out A condition	2A0D	✓	✓	✓	0	255	1	0	—	6.3.14
do 14	select out B condition	2A0E	✓	✓	✓	0	255	1	0	—	6.3.14
do 15	select out C condition	2A0F	✓	✓	✓	0	255	1	0	—	6.3.14
do 16	select out D condition	2A10	✓	✓	✓	0	255	1	0	—	6.3.14
do 17	out 1 condition logic	2A11	✓	✓	✓	0	255	1	0	—	6.3.14
do 18	out 2 condition logic	2A12	✓	✓	✓	0	255	1	0	—	6.3.14
do 19	out 3 condition logic	2A13	✓	✓	✓	0	255	1	0	—	6.3.14

*) dependent by the inverter size

do 21	out A condition logic	2A15	✓	✓	✓	0	255	1	0	—	6.3.14
do 22	out B condition logic	2A16	✓	✓	✓	0	255	1	0	—	6.3.14
do 23	out C condition logic	2A17	✓	✓	✓	0	255	1	0	—	6.3.14
do 24	out D condition logic	2A18	✓	✓	✓	0	255	1	0	—	6.3.14
do 25	output condition connection	2A19	✓	✓	✓	0	255	1	0	—	6.3.14
do 26	output filter 1 mode	2A1A	✓	✓	✓	0	2	1	0	—	6.3.12
do 27	output filter 2 mode	2A1B	✓	✓	✓	0	2	1	0	—	6.3.12
do 28	output filter 1 time	2A1C	✓	✓	✓	0	488	1	0	ms	6.3.12
do 29	output filter 2 time	2A1D	✓	✓	✓	0	488	1	0	ms	6.3.12
do 30	filter 1 condition connection	2A1E	✓	✓	✓	0	8	1	0	—	6.3.12
do 31	filter 2 condition connection	2A1F	✓	✓	✓	0	8	1	0	—	6.3.12
LE - Parameter		Addr.							[?]	see Page(s)	
LE 4	speed level 1	2B04	✓	-	✓	0,0	9999,5	0,5	0,0	rpm	6.3.11
LE 5	speed level 2	2B05	✓	-	✓	0,0	9999,5	0,5	0,0	rpm	6.3.11
LE 6	speed level 3	2B06	✓	-	✓	0,0	9999,5	0,5	0,0	rpm	6.3.11
LE 7	speed level 4	2B07	✓	-	✓	0,0	9999,5	0,5	0,0	rpm	6.3.11
LE 8	load level 1	2B08	✓	-	✓	0	200	1	0	%	6.3.11
LE 9	load level 2	2B09	✓	-	✓	0	200	1	0	%	6.3.11
LE 10	load level 3	2B0A	✓	-	✓	0	200	1	0	%	6.3.11
LE 11	load level 4	2B0B	✓	-	✓	0	200	1	0	%	6.3.11
LE 12	apparent current level 1	2B0C	✓	-	✓	0,0	500,0	0,1	0,0	A	6.3.11
LE 13	apparent current level 2	2B0D	✓	-	✓	0,0	500,0	0,1	0,0	A	6.3.11
LE 14	apparent current level 3	2B0E	✓	-	✓	0,0	500,0	0,1	0,0	A	6.3.11
LE 15	apparent current level 4	2B0F	✓	-	✓	0,0	500,0	0,1	0,0	A	6.3.11
LE 20	torque level 1	2B14	✓	-	✓	0,0	2000,0	0,1	0,0	Nm	6.3.11
LE 21	torque level 2	2B15	✓	-	✓	0,0	2000,0	0,1	0,0	Nm	6.3.11
LE 22	torque level 3	2B16	✓	-	✓	0,0	2000,0	0,1	0,0	Nm	6.3.11
LE 23	torque level 4	2B17	✓	-	✓	0,0	2000,0	0,1	0,0	Nm	6.3.11
LE 28	angular level 1	2B1C	✓	-	✓	0,0	2800,0	0,1	0,0	°	6.3.11
LE 29	angular level 2	2B1D	✓	-	✓	0,0	2800,0	0,1	0,0	°	6.3.11
LE 30	angular level 3	2B1E	✓	-	✓	0,0	2800,0	0,1	0,0	°	6.3.11
LE 31	angular level 4	2B1F	✓	-	✓	0,0	2800,0	0,1	0,0	°	6.3.11
LE 37	speed hysteresis	2B25	-	-	✓	0,0	9999,5	0,5	10,0	rpm	6.3.11, 6.8.4
LE 38	current hysteresis	2B26	-	-	✓	0,0	50,0	0,1	0,2	A	6.3.11
LE 39	angular hysteresis	2B27	-	-	✓	0,0	2800,0	0,1	1,0	°	6.3.11
LE 40	torque hysteresis	2B28	-	-	✓	0,0	1000,0	0,1	0,2	°	6.3.11
LE 48	position hysteresis	2B30	✓	-	✓	0	28000	1	0	inc	6.3.11
LE 50	position level 1 sign	2B32	✓	-	✓	0	2	1	0	—	6.3.11
LE 51	position level 1 high	2B33	✓	-	✓	0	65535	1	0	inc	6.3.11
LE 52	position level 1 low	2B34	✓	-	✓	0	65535	1	0	inc	6.3.11
LE 53	position level 2 sign	2B35	✓	-	✓	0	2	1	0	—	6.3.11
LE 54	position level 2 high	2B36	✓	-	✓	0	65535	1	0	inc	6.3.11
LE 55	position level 2 low	2B37	✓	-	✓	0	65535	1	0	inc	6.3.11
LE 56	position level 3 sign	2B38	✓	-	✓	0	2	1	0	—	6.3.11
LE 57	position level 3 high	2B39	✓	-	✓	0	65535	1	0	inc	6.3.11
LE 58	position level 3 low	2B3A	✓	-	✓	0	65535	1	0	inc	6.3.11
LE 59	position level 4 sign	2B3B	✓	-	✓	0	2	1	0	—	6.3.11
LE 60	position level 4 high	2B3C	✓	-	✓	0	65535	1	0	inc	6.3.11
LE 61	position level 4 low	2B3D	✓	-	✓	0	65535	1	0	inc	6.3.11
LE 66	delay time brake	2B42	-	-	✓	0	65535	1	0	ms	6.3.11, 6.8.3, 6.8.4
LE 67	switch off time brake	2B43	-	-	✓	0	5000	1	0	ms	6.3.11, 6.8.3, 6.8.4
LE 68	closing time brake	2B44	-	-	✓	0	5000	1	0	ms	6.3.11, 6.8.3, 6.8.4
LE 70	temperature switch time	2B46	-	-	✓	1,0	100,0	0,1	10,0	s	6.8.14
LE 71	set temperature	2B47	-	-	✓	20	OH-temp.	1	40	°C	6.8.14
LE 72	max. temperature	2B48	-	-	✓	20	OH-temp.	1	50	°C	6.8.14
LE 73	Min. temperature	2B49	-	-	✓	20	OH-temp.	1	30	°C	6.8.14
LE 74	collant warning	2B50	-	-	✓	1	50	1	5	—	6.8.14
In - Parameter		Addr.							[?]	see Page(s)	
In 0	inverter Type	2C00	-	-	-	-	-	table	rating plate	—	6.1.16
In 1	rated inverter current	2C01	-	-	-	370	0,1	LTK	A	—	6.1.16
In 4	software version	2C04	-	-	-	-	1	-	—	—	6.1.16
In 5	software date	2C05	-	-	-	-	0,1	-	—	—	6.1.17
In 6	configfile no.	2C06	-	-	-	0	255	1	52	—	6.1.17
In 7	serial no. (date)	2C07	-	-	-	0	65535	1	0	—	6.1.17
In 8	serial no. (counter)	2C08	-	-	-	0	65535	1	0	—	6.1.17
In 9	serial no. (AB-no. high)	2C09	-	-	-	0	65535	1	0	—	6.1.17
In 10	serial no. (AB-no. low)	2C0A	-	-	-	0	65535	1	0	—	6.1.17
In 11	cust. no. (high)	2C0B	-	-	-	0	65535	1	0	—	6.1.17, 6.9.5
In 12	cust. no. (low)	2C0C	-	-	-	0	65535	1	0	—	6.1.17
In 40	last error	2C28	-	-	-	0	63	1	0	—	6.1.18
In 41	error counter OC	2C29	-	-	-	0	255	1	0	—	6.1.18
In 42	error counter OL	2C2A	-	-	-	0	255	1	0	—	6.1.18
In 43	error counter OP	2C2B	-	-	-	0	255	1	0	—	6.1.18
In 44	error counter OH	2C2C	-	-	-	0	255	1	0	—	6.1.18
In 45	error counter watchdog	2C2D	-	-	-	0	255	1	0	—	6.1.18
In 54	software version DSP	2C36	-	-	-	-	-	0,1	-	—	6.1.18

*) dependent by the inverter size

Parameter

In 55	software date DSP	2C37	-	-	-	-	-	0,1	-	—	6.1.18
In 56	feedback-system channel1	2C38	-	-	-	0	7	1	-	—	6.1.18
In 57	feedback-system channel2	2C39	-	-	-	0	7	1	-	—	6.1.18, 6.9.5
In 60	last error (t-1)	2C3C	-	-	-	-	-	1	-	—	6.1.19
In 61	last error (t-2)	2C3D	-	-	-	-	-	1	-	—	6.1.19
In 62	last error (t-3)	2C3E	-	-	-	-	-	1	-	—	6.1.19
In 63	last error (t-4)	2C3F	-	-	-	-	-	1	-	—	6.1.19
Sn - Parameter		Addr.							[?]	see Page(s)	
Sn 0	synchron control	3400	✓	-	✓	0 : off	3	1	0 : off	—	6.10.3, 6.10.6
Sn 1	Kp synchron control	3401	✓	-	✓	0	65535	1	0	—	6.10.3
Sn 2	gear ratio master/slave	3402	✓	-	✓	-20	20	0,001	1	—	6.10.3
Sn 5	angular shifting slave activation	3405	-	✓	✓	0	2	1	0	—	6.10.3
Sn 6	angular shifting slave value lo	3406	-	-	✓	0,0	360,0	0,1	0,0	°	6.10.3
Sn 7	angular shifting slave value hi	3407	-	-	✓	0	65535	1	0	rpm	6.10.3
Sn 8	register function period	3408	-	-	-	0	0,100	0,001	0,001	—	6.10.10
Sn 19	slave ratio	3414	-	-	-	1	15	1	1	—	—
Sn 21	register function filter mode	3415	-	-	-	0 : off	2	1	0	—	6.10.10
Sn 22	period level for angular correction sign	3417	-	-	-	0	2	1	2	—	6.10.11
Sn 23	period level for angular correction high	3417	-	-	-	0	65535	1	0	inc.	6.10.11
Sn 24	period level for angular correction low	3417	-	-	-	0	65535	1	8192	inc.	6.10.11
Sn 25	register function correction mode	3419	-	-	-	0	2	1	0	—	6.10.11
Sn 26	register function max angle for correc. sign	341A	-	-	-	0	2	1	2	—	6.10.11
Sn 27	register function max angle for correc. high	341B	-	-	-	0	65535	1	0	inc.	6.10.11
Sn 28	register function max angle for correc. low	341C	-	-	-	0	65535	1	0	inc.	6.10.11
Sn 29	minimum speed for angular offset 1	341D	-	-	-	0	15000	0,5	0	rpm	6.10.11
Sn 30	angular offset 1 sign	341E	-	-	-	0	2	1	2	—	6.10.11
Sn 31	angular offset 1 high	341F	-	-	-	0	65535	1	0	inc.	6.10.11
Sn 32	angular offset 1 low	3420	-	-	-	0	65535	1	0	inc.	6.10.11
Sn 33	maximum speed for angular offset 2	3421	-	-	-	0	15000	0,5	0	rpm	6.10.11
Sn 34	angular offset 2 sign	3422	-	-	-	0	2	1	2	—	6.10.11
Sn 35	angular offset 2 high	3423	-	-	-	0	65535	1	0	inc.	6.10.11
Sn 36	angular offset 2 low	3424	-	-	-	0	65535	1	0	inc.	6.10.11
Sn 40	slave register display sign	3428	-	-	-	0	2	1	2	—	6.10.11
Sn 41	slave register display high	3429	-	-	-	0	65535	1	0	inc.	6.10.11
Sn 42	slave register display low	342A	-	-	-	0	65535	1	0	inc.	6.10.11
Sn 43	master register display sign	342B	-	-	-	0	2	1	2	—	6.10.11
Sn 44	master register display high	342C	-	-	-	0	65535	1	0	inc.	6.10.11
Sn 45	master register display low	342D	-	-	-	0	65535	1	0	inc.	6.10.11
Sn 46	period duration display sign	342E	-	-	-	0	2	1	2	—	6.10.11
Sn 47	period duration display high	342F	-	-	-	0	65535	1	0	inc.	6.10.11
Sn 48	period duration display low	3430	-	-	-	0	65535	1	0	inc.	6.10.11
Sn 49	period duration display sign	3431	-	-	-	0	2	1	2	—	6.10.11
Sn 50	period duration display high	3432	-	-	-	0	65535	1	0	inc.	6.10.11
Sn 51	period duration display low	3433	-	-	-	0	65535	1	0	inc.	6.10.11
Sn 52	register function max correction sign	3434	-	-	-	0	2	1	2	—	6.10.11
Sn 53	register function max correction high	3435	-	-	-	0	65535	1	0	inc.	6.10.11
Sn 54	register function max correction low	3436	-	-	-	0	65535	1	16834	inc.	6.10.11
Sn 55	start offset sign	3431	-	-	-	0	2	1	2	—	6.10.3
Sn 56	start offset high	3432	-	-	-	0	65535	1	0	inc.	6.10.3
Sn 57	start offset low	3433	-	-	-	0	65535	1	0	inc.	6.10.3
Pc - Parameter		Addr.							[?]	see Page(s)	
Pc 0	control mode	3600	-	✓	✓	0	1	1	0	—	6.11.3
Pc 1	position input mode	3601	-	✓	✓	0	3	1	3	—	6.11.6
Pc 4	limit switch left sign	3604	-	-	✓	0	1	1	2	—	6.11.10
Pc 5	limit switch left high	3605	-	-	✓	0	65535	1	8000h	inc.	6.11.10
Pc 6	limit switch left low	3606	-	-	✓	0	65535	1	0	inc.	6.11.10
Pc 7	limit switch right sign	3607	-	-	✓	0	1	1	2	—	6.11.10
Pc 8	limit switch right high	3608	-	-	✓	0	65535	1	7fffh	inc.	6.11.10
Pc 9	limit switch right low	3609	-	-	✓	0	65535	1	ffffh	inc.	6.11.10
Pc 10	mode of position reference	360A	-	✓	✓	0	3	1	0	—	6.11.17
Pc 11	reference point sign	360B	-	-	✓	0	1	1	0	—	6.11.5
Pc 12	reference point high	360C	-	-	✓	0	65535	1	0	—	6.11.5
Pc 13	reference point low	360D	-	-	✓	0	65535	1	0	—	6.11.5
Pc 14	reference speed 1	360E	-	-	✓	-3000,0	3000,0	0,5	100,0	rpm	6.10.4, 6.11.16
Pc 16	encoder mode for positioning	3610	-	✓	✓	0	1	1	0	—	6.11.4
Pc 17	gear factor for positioning	3611	-	✓	✓	1,00	250,00	0,01	1,00	—	6.11.4
Pc 18	distance after abort high	3612	✓	-	-	0	32767	1	0	inc.	6.11.4
Pc 19	distance after abort low	3613	✓	-	-	0	65535	1	0	inc.	6.11.4
Pc 33	distance before abort high	3621	✓	-	-	0	32767	1	0	inc.	6.11.5
Pc 34	distance before abort low	3622	✓	-	-	0	65535	1	0	inc.	6.11.15
Pc 35	posi init mode	3623	-	-	-	0	2	1	0	inc.	6.11.16
Pc 36	posi stop mode	3624	-	-	-	0	3	1	0	—	6.11.15

Pd - Parameter	Addr.								[?]	see Page(s)
Pd 0 posi mode	3700	✓	-	✓	0	2	1	0	—	6.11.3
Pd 1 manuall start	3701	-	✓	✓	0	4	1	0	—	6.10.4, 6.11.9, 6.11.10
Pd 2 Kp position	3702	✓	-	✓	0	65535	1	30	—	6.11.9
Pd 3 limit for Kp position	3703	✓	-	✓	0,0	500,0	0,5	250,0	rpm	6.11.8, 6.11.9
Pd 5 s curve time	3705	✓	-	✓	0,01	8,00	0,01	0,10	s	6.11.8, 6.11.9
Pd 6 acceleration time	3706	✓	-	✓	0,01	8,00	0,01	1,00	s	6.11.8, 6.11.9
Pd 7 max speed for position	3707	✓	-	✓	0	10000	1	1000	rpm	6.11.8, 6.11.9
Pd 8 set position sign	3708	✓	-	✓	0	1	1	0	—	6.11.8, 6.11.9
Pd 9 set position high	3709	✓	-	✓	0	65535	1	0	inc	6.11.4, 6.11.5, 6.11.6
Pd 10 set position low	370A	✓	-	✓	0	65535	1	0	inc	6.11.4, 6.11.5, 6.11.6
Pd 11 mode of positioning	370B	✓	-	✓	0	1	1	0	—	6.11.7
Pd 12 position deviation	370C	✓	-	✓	0	65535	1	1000	inc	6.11.7
EC - Parameter	Addr.								[?]	see Page(s)
EC 0 encoder interface 1	3800	-	-	✓	-	-	1	-	—	6.9.3
EC 1 line number encoder 1	3801	-	-	-	256	10000	1	2500	inc.	6.9.5
EC 2 track change encoder 1	3802	-	-	-	0 : off	1 : on	1	0 : off	—	6.9.5
EC 5 clock freq. encoder 1	3805	-	-	-	5,00	10,00	0,01	10,00	kHz	6.9.6
EC 6 encoder 1 mode	3806	-	-	-	0	1	1	0	—	6.9.5
EC 8 speed scan time encoder 1	3808	-	-	-	0	5	1	3	—	6.9.12
EC 9 Current input resolver	3809	-	-	-	-1 : Auto	72,0	0,1	7,7	mA	6.9.6
EC 10 encoder interface 2	380A	-	-	✓	-	-	1	-	—	6.9.3
EC 11 line number encoder 2	380B	-	-	-	256	10000	1	2500	inc.	6.9.5
EC 12 track change encoder 2	380C	-	-	-	0 : off	1 : on	1	0 : off	—	6.9.5
EC 13 operat. mode encoder 2	380D	-	-	-	0	1	1	0	—	6.9.8
EC 14 multi-turn resolution encoder 2	380E	-	-	-	0	13	1	0	—	6.9.9
EC 15 clock freq. encoder 2	380F	-	-	-	0	1	1	0	—	6.9.9
EC 16 data format encoder 2	3810	-	-	-	0	1	1	0	—	6.9.9
EC 18 speed scan time encoder 2	3812	-	-	-	0	5	1	0	—	6.9.12
EC 20 hiper-type	3814	-	-	✓	-	-	1	-	—	6.9.6
EC 21 hiper-status	3815	-	-	✓	-	-	1	-	—	6.9.7
AA - Parameter	Addr.								[?]	see Page(s)
AA 0 graph 1 parameter selection	3200	-	-	✓	0	65535	1	2001	—	6.8.7
AA 1 graph 2 parameter selection	3201	-	-	✓	0	65535	1	-1 : off	—	6.8.7
AA 2 graph 3 parameter selection	3202	-	-	✓	0	65535	1	-1 : off	—	6.8.7
AA 3 graph 4 parameter selection	3203	-	-	✓	0	65535	1	-1 : off	—	6.8.7
AA 4 time base	3204	-	-	✓	0,001	32,000	0,001	0,001	sec	6.8.7
AA 5 trigger source	3205	-	-	✓	0	4095	1	6	—	6.8.7
AA 6 trigger position	3206	-	-	✓	0	100	1	50	—	6.8.7
AA 7 synchronisation	3207	-	-	✓	-32767	32767	1	0	—	6.8.8
AA 8 trigger status	3208	-	-	✓	0	2	1	0	—	6.8.8
AA 9 select graph address	3209	-	-	✓	0	1999	1	0	—	6.8.8
AA 10 read graph 1	320A	-	-	-	0	-	1	-	—	6.8.8
AA 11 read graph 2	320B	-	-	-	0	-	1	-	—	6.8.8
AA 12 read graph 3	320C	-	-	-	0	-	1	-	—	6.8.8
AA 13 read graph 4	320D	-	-	-	0	-	1	-	—	6.8.8

- 1. Introduction
- 2. Summary
- 3. Hardware
- 4. Operation
- 5. Parameter
- 6. Functions**
- 7. Start-up
- 8. Special Operation
- 9. Error Assistance
- 10. Project Planning
- 11. Networks
- 12. Applications
- 13. Annex

- 6.1 Operating and Unit Data**
- 6.2 Analog In- and Outputs
- 6.3 Digital In- and Outputs
- 6.4 Set Value and Ramp Adjustment
- 6.5 Motor Data and Controller Adjustment
- 6.6 Keep on Running Functions
- 6.7 Parameter Sets
- 6.8 Special Functions
- 6.9 Encoder Interface
- 6.10 Synchronous Control
- 6.11 Positioning Module
- 6.12 CP-Parameter Definition

- 6.1.1 Summary of ru-Parameter 3
- 6.1.2 Summary In-Parameter 3
- 6.1.3 Explanation to Parameter Description 4
- 6.1.4 Description of ru-Parameter 5
- 6.1.5 Description of In-Parameter 16

Chapter 6	Section 1	Page 2	Date 23.10.02	Name: Basis KEB COMBIVERT F4-F	© KEB Antriebstechnik, 2002 All Rights reserved
---------------------	---------------------	------------------	------------------	--	--

6. Functional Description

6.1 Operating and Unit Datas

6.1.1 Summary of ru-Parameter

The parameter groups „ru“ and „In“ are described in this chapter. They serve for the operational monitoring, error analysis and evaluation as well as for the unit identification.

The ru- (run) parameter group represents the multimeter of the inverter. Here speeds, currents, voltages etc. are displayed which allow a conclusion on the operating condition of the drive. This can be especially helpful for the start-up of a system or with regard to trouble shooting. Following parameters are available:

ru. 0 Inverter state	ru. 22 Ref1 display
ru. 1 Actual speed display	ru. 23 Ref2 display
ru. 2 Actual torque display	ru. 24 OL counter display
ru. 4 Set speed display	ru. 25 Peak apparent current
ru. 7 Actual inverter utilization	ru. 26 Actual speed master
ru. 8 Peak inverter utilization	ru. 27 Angular deviation
ru. 9 Apparent current	ru. 28 Speed deviation
ru. 10 Active current	ru. 29 Heat sink temperature
ru. 11 Actual DC voltage	ru. 31 Power on counter
ru. 12 Peak DC voltage	ru. 32 modulation on counter
ru. 14 Input terminal state	ru. 35 Actual position sign
ru. 15 Output terminal state	ru. 36 Actual position high
ru. 16 Internal input state	ru. 37 Actual position low
ru. 17 Internal output state	ru. 38 Set position sign
ru. 18 Actual parameter set	ru. 39 Set position high
ru. 20 Speed REF display	ru. 40 Set position low

6.1.2 Summary of In-Parameter

The In- (Information) parameter group includes data and information about the identification of the hardware and software as well as to the type and number of the errors that occurred. Following parameters are available:

In. 0 Inverter type	In. 40 Last error
In. 1 Rated inverter current	In. 41 Error counter OC
In. 4 Software version	In. 42 Error counter OL
In. 5 Software date	In. 43 Error counter OP
In. 6 Configfile no.	In. 44 Error counter OH
In. 7 Serial number (date)	In. 45 Error counter watchdog
In. 8 Serial number (counter)	In. 54 Software version DSP
In. 9 Serial number (Ackn.-No. high)	In. 55 Software date DSP
In. 10 Serial number (Ackn.-No. low)	In. 56 Feedback-system channel 1
In. 11 Customer number (high)	In. 57 Feedback-system channel 2
In. 12 Customer number (low)	

6.1.3 Explanation to Parameter Description

The parameters described in the following section receive for a better survey a symbol line with following details:

ru. xx	Parameter name								
Adr.									
2016h	<input checked="" type="checkbox"/>	<input checked="" type="checkbox"/>	<input checked="" type="checkbox"/>	-100,0	100,0	0,1	%	-	
				Value range			Unit	Default value	
				Lower limit	Upper limit	Resolution, increments			
				Enter parameter <input checked="" type="checkbox"/> active after „Enter“ <input type="checkbox"/> active immediately					
				Parameter <input checked="" type="checkbox"/> set-programmable <input type="checkbox"/> not programmable					
				Parameter <input checked="" type="checkbox"/> writable <input type="checkbox"/> readable-only					
	Information line Contains particularities, tips and cross references								

Free for user adjustments

Parameter group and parameter number

Parameter address

ru. xx	Parameter name								
Adr.									
2016h	<input checked="" type="checkbox"/>	<input checked="" type="checkbox"/>	<input checked="" type="checkbox"/>	-100,0	100,0	0,1	%	-	



Value range

Lower limit

Upper limit

Resolution, increments

Unit

Default value

Enter parameter

- active after „Enter“
- active immediately

Parameter

- set-programmable
- not programmable









Parameter

- writable
- readable-only

Information line

Contains particularities, tips and cross references

6.1.4 Description of ru-Parameter

ru. 0	Inverter state								
Adr.									
2000h	<input type="checkbox"/>	<input type="checkbox"/>	<input type="checkbox"/>	0	111	-	-	-

In parameter „inverter status“ the actual operating condition of the frequency inverter is displayed. The operating conditions can be divided into four groups:

1. Ready for operation signals
2. Process signals
3. Fault signals
4. Error messages

1. Ready for operation signals

These signals are given upon completion of initialization and when the frequency inverter is ready for operation:

Display	Bus	Meaning	
noP	0	<i>no Operation</i>	<ul style="list-style-type: none"> - control release (terminal X2.1) not activated - modulation disabled - output voltage = 0 V/drive without control
LS	70	<i>Low Speed</i>	<ul style="list-style-type: none"> - control release (terminal X2.1) active - rotation setting is missing - modulation disabled - output voltage = 0 V/drive without control

2. Process signals

The signals occur during the normal operation of the frequency inverter:

Display	Bus	Meaning	(drive conditions refer to the setpoint value)
FAcc	64	<i>Forward Acceleration</i>	- drive accelerates with rotation forward
FdEc	65	<i>Forward Deceleration</i>	- drive decelerates with rotation forward
Fcon	66	<i>Forward Constant</i>	- drive operates with constant speed and rotation forward
rAcc	67	<i>Reverse Acceleration</i>	- drive accelerates with rotation reverse
rdEc	68	<i>Reverse Deceleration</i>	- drive decelerates with rotation reverse
rcon	69	<i>Reverse Constant</i>	- drive operates with constant speed and rotation reverse
rFP	79	<i>Ready for Positioning</i>	<ul style="list-style-type: none"> - positioning module active - drive is in „off“-position and waits for positioning command
PA	80	<i>Positioning Active</i>	<ul style="list-style-type: none"> - positioning module active - drive carries out positioning command
SrA	82	<i>Search for Reference Active</i>	<ul style="list-style-type: none"> - positioning or synchronous module active - drive performs reference point run

3. Fault signals

The reaction of the drive to the fault signals listed below (abnormal stopping) can be determined with parameter Pn.20 and Pn.23...Pn.26:

Display	Bus	Meaning	
A.EF	90	<i>Abnormal Stopping</i>	- The signal for an external fault is given to a programmable digital input. (reaction of the drive see parameter Pn.20)
A.buS	93	<i>Abnormal Stopping</i>	- The adjusted Watchdog-time (parameter ud.8) of the serial communication was exceeded. (reaction of the drive see parameter Pn.23)
A.PrF	94	<i>Abnormal Stopping Prohibited Rotation Forward</i>	- At setpoint direction forward terminal F (rotation release forward) is not active. (reaction of the drive see parameter Pn.24)
A.Prr	95	<i>Abnormal Stopping Prohibited Rotation Reverse</i>	- At setpoint direction reverse terminal R (rotation release reverse) is not active. (reaction of the drive see parameter Pn.24)
A.dOH	96	<i>Abnormal Stopping Drive Overheat</i>	- The temperature monitoring of the motor has tripped and the pre-warning time (Pn.16) is active. (reaction of the drive see parameter Pn.25)
A.OH	99	<i>Abnormal Stopping Overheat</i>	- The temperature monitoring of the frequency inverter has tripped and the prewarning time (10 s) is active. (reaction of the drive see parameter Pn.26)

4. Error messages

Errors cause the immediate deactivation of the modulation and the generation of corresponding error messages (see table). Before carrying out a restart remove the the error first and then actuate reset.

Display	Bus	Meaning	
E.OP	1	<i>Error Overpotential</i>	- The DC-link voltage has exceeded the permissible value.
E.UP	2	<i>Error Underpotential</i>	- The DC-link voltage has fallen below the permissible value.
E.OC	4	<i>Error Overcurrent</i>	- The output current has exceeded the permissible value.
E.OH	8	<i>Error Overheat</i>	- The temperature monitoring of the frequency inverter has tripped and the prewarning time (10s) is expired.
E.dOH	9	<i>Error Drive Overheat</i>	- The temperature monitoring of the motor has tripped and the prewarning time (Pn.16) is expired.
E.nOH	36	<i>Error no Overheat</i>	- Overtemperature error no longer exists, the error messages (E.OH / E.dOH) can be reset and the frequency inverter restarted.
E.OL	16	<i>Error Overload</i>	- The operation of the frequency inverter in the overload range has exceeded the permissible time (see overload characteristic in the Instruction Manual Part 2).
E.OL2	53	<i>Error Overload 2</i>	- Same meaning as E.OL, but occurs only in the lower frequency range (<3 Hz) (see overload characteristic in the Instruction Manual Part 2).
E.nOL	17	<i>Error no Overload</i>	- After the cooling down phase the overload error (E.OL or E.OL2) no longer exists, the error message can be reset and the frequency inverter restarted.
E.buS	18	<i>Error Bus</i>	- The adjusted Watchdog-time (parameter ud.8) of the serial communication has been exceeded (only at parameter Pn.23 = 0).
E.LSF	15	<i>Error Load Shunt</i>	- After switching on the frequency inverter the input voltage is too low or the load shunt relay is not switching (monitoring with load shunt relay not available for all unit sizes).
E.EF	31	<i>Error External Fault</i>	- The signal for an external error is given to a programmable digital input (only at parameter Pn.20 = 0).
E.SEt	39	<i>Error Set</i>	- Set selection error: selected parameter set is locked (see parameter Fr.3)
E.PrF	46	<i>Error Prohibited</i>	- At setpoint rotation forward terminal F (rotation release forward) is not active (only at parameter Pn.24 = 0).
E.Prr	47	<i>Error Prohibited</i>	- At setpoint rotation reverse terminal R (rotation release reverse) is not active (only at parameter Pn.24 = 0).
E.dSP	51	<i>Error Digital Signal Processor</i>	- Processor - error
E.Hyb	52	<i>Error Hybrid</i>	- Control card error: carry out Power-on reset; if the error message continues to show, the error can be removed only in the factory.
E.PuC	49	<i>Error Power Unit</i>	- Control card error: carry out Power-on reset; if the error message continues to show, the error can be removed only in the factory.
E.SLF	110	<i>Error Software Limit</i>	- Selection of setpoint position outside the adjusted software limit at rotation forward (also see parameter Pc.4...Pc.6 positioning module)
E.SLr	111	<i>Error Software Limit</i>	- Selection of setpoint position outside the adjusted software limit at rotation reverse (also see parameter Pc.7...Pc.9 positioning module)

ru. 1 Actual speed display									
Adr.									
2001h	<input type="checkbox"/>	<input type="checkbox"/>	<input type="checkbox"/>	-9999,5	9999,5	0,5	rpm	-

Display of actual motor speed (incremental encoder 1).

! For a correct display value observe the adjustment of the encoder line number (parameter dr.25) and the rotation direction (parameter dr.29) of the incremental encoder!

A counter-clockwise rotating field (reverse) is represented by a negative sign. Precondition is the in-phase connection of the motor.



ru. 2 Actual torque display									
Adr.									
2002h	<input type="checkbox"/>	<input type="checkbox"/>	<input type="checkbox"/>	0	1000,0	0,1	Nm	-

The displayed value corresponds to the actual motor torque in Nm. The value is calculated from the active current. In controlled operation (CS.23 = 0) the value for the actual torque is set to zero.

i Because of normal type differences and temperature deviations of the motors as well as measuring inaccuracies of the inverter tolerances of up to 30 % are possible in the base speed range. Dependent on the dimensioning or in the field weakening range higher tolerances can also occur in few cases.

Requirement for the torque display is the adjustment of the motor data in the dr-parameters. If the real motor data deviate strongly from the data on the name plate the operating performance can be optimized by entering the real data. It may be sensible to reduce the rated slip by approx. 10...20% (i.e. increase rated speed dr.1). The adjustment of the name plata data is sufficient for a start-up.

ru. 4 Set speed display									
Adr.									
2004h	<input type="checkbox"/>	<input type="checkbox"/>	<input type="checkbox"/>	-14000	14000	0,5	rpm	-

In ru. 4 the setpoint speed is displayed at the output of the ramp generator. If the inverter is locked or if an 'abnormal' operating condition is active, the value 0 rpm is displayed.

This parameter is, above all, important for the visualization with the inverter scope. In controlled operation (CS.23 = 0) the output frequency is converted and displayed in rotations per minute (precondition: correct motor data for the number of pole pair calculation is available).

ru. 7 Actual inverter utilization									
Adr.									
2007h	<input type="checkbox"/>	<input type="checkbox"/>	<input type="checkbox"/>	0	200	1	%	-

Display of the actual load related to the rated current of the inverter. Only positive values are displayed, thus a differentiation between motoric and generative operation is not possible.

ru. 8 Peak inverter utilization									
Adr.									
2008h	<input checked="" type="checkbox"/>	<input type="checkbox"/>	<input type="checkbox"/>	0	200	1	%	-

ru.8 allows the detection of short-time peak loads during an operating cycle. For that the highest detected value of ru.7 is stored in ru.8. The peak value memory is cleared by pressing the keys UP or DOWN or by bus by writing any chosen value to the address of ru.8. The disconnection of the inverter also results in a clearing of the memory.

ru.9 Apparent current									
Adr.									
2009h	<input type="checkbox"/>	<input type="checkbox"/>	<input type="checkbox"/>	0	unit-dependent	0,1	A	-

Display of actual apparent current. The maximum values depend on the size of the inverter.

ru.10 Active current									
Adr.									
200Ah	<input type="checkbox"/>	<input type="checkbox"/>	<input type="checkbox"/>	0	unit-dependent	0,1	A	-

Display of the torque-forming active current. Precondition is the input of the motor data into dr.0...dr.4. The maximum values depend on the size of the inverter. With regard to limitations of the accuracy refer to ru.2. In controlled operation (CS.23 = 0) the display always shows 0.0 A.

ru.11 Actual DC voltage									
Adr.									
200Bh	<input type="checkbox"/>	<input type="checkbox"/>	<input type="checkbox"/>	200	999	1	V	-

Display of actual DC-link voltage. Typical values are for
 normal operation: 230V-class approx. 300-330V in case of fault (E.OP): 230V-class approx.390V
 400V-class approx. 530-620V 400V-class approx.800V

ru.12 Peak DC voltage									
Adr.									
200Ch	<input checked="" type="checkbox"/>	<input type="checkbox"/>	<input type="checkbox"/>	200	999	1	%	-

ru.12 allows the detection of short-time voltage rises within an operating cycle. For that the highest detected value of ru.11 is stored in ru.12. The peak value memory is cleared by pressing the keys UP or DOWN or by bus by writing any chosen value to the address of ru.12. The disconnection of the inverter also results in a clearing of the memory.

ru.14 Input terminal state									
Adr.									
200Eh	<input type="checkbox"/>	<input type="checkbox"/>	<input type="checkbox"/>	0	127	1	-	-









Display of the actual triggered digital inputs. Whether the input is inverted or the internal acceptance takes place through edge triggering or strobe is irrelevant for the display. According to following table a certain decimal value is given out for each digital input. If several inputs are triggered then the sum of their decimal values is displayed.

Bit -No.	Decimal value	Input (standard program)	Terminal
0	1	ST (control release)	X2.1
1	2	I4 (Reset)	X2.2
2	4	I5 (rotation Forward)	X2.3
3	8	I6 (rotation Reverse)	X2.4
4	16	I1 (prog. input 1)	X2.5
5	32	I2 (prog. input 2)	X2.6
6	64	I3 (prog. input 3)	X2.7

ru.15 Output terminal state									
Adr.									
200Fh	<input type="checkbox"/>	<input type="checkbox"/>	<input type="checkbox"/>	0	247	1	-	-

Display of the currently set external and internal digital outputs. According to following table a certain decimal value is given out for each digital output. If several outputs are set then the sum of their decimal values is displayed.









Bit -No.	Decimal value	Output	Terminal
0	1	D1 (transistor output)	X2.8
1	2	D2 (transistor output)	X2.9
2	4	Out 3 (output relay)	X2.20 , 21 , 22
4	16	Out A (internal output A)	none
5	32	Out B (internal output B)	none
6	64	Out C (internal output C)	none
7	128	Out D (internal output D)	none

ru.16 Internal input state									
Adr.									
2010h	<input type="checkbox"/>	<input type="checkbox"/>	<input type="checkbox"/>	0	4095	1	-	-

Display of the currently set external and internal digital inputs. The input is considered as set when it is available as active signal for further processing (i.e. acceptance by strobe, edge triggering or logic operation). According to following table a certain decimal value is given out for each digital input. If several inputs are set then the sum of their decimal values is displayed.

Bit -No.	Decimal value	Input (standard program)	Terminal
0	1	ST (control release)	X2.1
1	2	I4 (Reset)	X2.2
2	4	I5 (rotation Forward)	X2.3
3	8	I6 (rotation Reverse)	X2.4
4	16	I1 (prog. input 1)	X2.5
5	32	I2 (prog. input 2)	X2.6
6	64	I3 (prog. input 3)	X2.7
7	128	no function	
8	256	IA (internal input A)	none
9	512	IB (internal input B)	none
10	1024	IC (internal input C)	none
11	2048	ID (internal input D)	none

() - Standard setting

ru.17 Internal output state									
Adr.									
2011h	<input type="checkbox"/>	<input type="checkbox"/>	<input type="checkbox"/>	0	255	1	-	-

With parameters do.1...do.8 switching conditions can be selected which serve as basis for the setting of the outputs. This parameter indicates which of the selected switching conditions are met, before they are linked by the programmable logic or inverted. According to following table a certain decimal value is given out for the parameters do.1...do.8. If several of the switching conditions selected with these parameters are met, then the sum of the decimal values is displayed.

Bit -No.	Decimal value	Output
0	1	Switching condition 1 (do.1)
1	2	Switching condition 2 (do.2)
2	4	Switching condition 3 (do.3)
3	8	Switching condition 4 (do.4)
4	16	Switching condition 5 (do.5)
5	32	Switching condition 6 (do.6)
6	64	Switching condition 7 (do.7)
7	128	Switching condition 8 (do.8)

ru.18 Actual parameter set									
Adr.									
2012h	<input type="checkbox"/>	<input type="checkbox"/>	<input type="checkbox"/>	0	7	1	-	-

The frequency inverter F4-F can fall back on 8 internal parameter sets (0-7). Through corresponding programming the inverter can independently change parameter sets and is thus able to drive different operating modes. This parameter shows the parameter set, with which the inverter is currently running. Independent of it another parameter set can be edited by bus.

ru.20 Speed REF display									
Adr.									
2014h	<input type="checkbox"/>	<input type="checkbox"/>	<input type="checkbox"/>	-14000	14000	0,5	rpm	-

In ru.20 the setpoint speed at the input of the ramp generator is displayed. As long as no other function with a higher priority is activated, this speed becomes the setpoint value for the control. Functions with higher priorities are e.g. 'abnormal stopping', jogging' and 'noP' or active synchronous control/positioning. Thus it is possible to check the adjusted setpoint value prior to start-up. If no direction of rotation is selected then the setpoint value, which would occur at clockwise rotation, is indicated.

ru.22 REF1 display (terminal X2.14 and X2.15)									
Adr.									
2016h	<input type="checkbox"/>	<input type="checkbox"/>	<input type="checkbox"/>	-100	100	0,1	%	-

This parameters displays the percentual value of the signal at the setpoint input REF1 (terminal X2.14/X2.15).
-10V...0...+10V = -100%...0...100%

ru.23 REF2 display (terminal X2.16 and X2.17)									
Adr.									
2017h	<input type="checkbox"/>	<input type="checkbox"/>	<input type="checkbox"/>	-100	100	0,1	%	-

This parameter displays the percentual value of the signal at the setpoint input REF2 (terminal X2.16 / X2.17).
-10V...0...+10V = -100%...0...100%

ru.24 OL counter display									
Adr.									
2018h	<input type="checkbox"/>	<input type="checkbox"/>	<input type="checkbox"/>	0	100	1	%	-

To prevent „E.OL“ errors caused by too high loads (load reduction), the internal counter content of the OL-counter can be made visible herewith. At 100 % the inverter switches off with the error „E.OL“. The error can be reset only after a cooling time (blinking display „E.nOL“).

ru.25 Peak apparent current									
Adr.									
2019h	<input checked="" type="checkbox"/>	<input type="checkbox"/>	<input type="checkbox"/>	0	unit-dependent	0,1	A	-

ru.25 allows the detection of short-time peaks of the motor current within an operating cycle. For that the highest detected value of ru.9 is stored. The peak value memory is cleared by pressing the keys UP or DOWN or by bus by writing any chosen value to the address of ru.25. A disconnection of the inverter also results in a clearing of the memory.

ru.26 Actual speed master									
Adr.									
201Ah	<input type="checkbox"/>	<input type="checkbox"/>	<input type="checkbox"/>	-14000	14000	0,5	rpm	-

Shows the actual motor speed of the drive connected to the encoder interface 2 (X5).
Precondition: Encoder line number (dr.30) and rotation of encoder (dr.34) are adjusted correctly.

ru.27 Angular deviation									
Adr.									
201Bh	<input type="checkbox"/>	<input type="checkbox"/>	<input type="checkbox"/>	-360,0	360,0	0,1	°	-

Display of the angular displacement between setpoint position and actual position in the positioning and synchronous operation.

ru.28 Speed deviation									
Adr.									
201Ch	<input type="checkbox"/>	<input type="checkbox"/>	<input type="checkbox"/>	-14000	14000	0,5	rpm	-

Display of speed droop between actual speed of the master and actual speed of the slave (independent of rotation direction).

Positive speed values: The master drive rotates faster than the slave drive.
Negative speed values: The slave drive rotates faster than the master drive.

ru.29 Heat sink temperature									
Adr.									
201Dh	<input type="checkbox"/>	<input type="checkbox"/>	<input type="checkbox"/>	0	100	1	°C	-









ru.29 shows the actual heat sink temperature of the inverter.

ru.31 Power on counter									
Adr.									
201Fh	<input type="checkbox"/>	<input type="checkbox"/>	<input type="checkbox"/>	0	65535	1	h	-
<p>The operating hours meter 1 displays the time the inverter was switched on. The indicated value includes all operating phases. On attaining the maximum value (approx. 7.5 years) the display remains on the maximum value.</p>									

ru.32 modulation on counter									
Adr.									
2020h	<input type="checkbox"/>	<input type="checkbox"/>	<input type="checkbox"/>	0	65535	1	h	-
<p>The operating hours meter 2 displays the time the inverter was active (motor controlled). On attaining the maximum value (approx. 7.5 years) the display remains on the maximum value.</p>									

ru.35 Actual position sign									
Adr.									
2023h	<input type="checkbox"/>	<input type="checkbox"/>	<input type="checkbox"/>	0	1	1	-	-
<p>Only active with activated positioning module!!! At decimal positioning display (Pc.1 = 0 or 1) it shows the sign of the actual position. At hexadecimal display (Pc.1 = 2 or 3) the parameter is without function.</p> <ul style="list-style-type: none"> 0: Actual position in positive direction from zero point 1: Actual position in negative direction from zero point 2: without function since hexadecimal display is selected <p>(Standard setting zero point = reference point)</p>									









ru.36 Actual position high									
Adr.									
2024h	<input type="checkbox"/>	<input type="checkbox"/>	<input type="checkbox"/>	0 (-65535)	65535	1	inc	-	depend on Pc.1
<p>Only active at activated positioning module!!! Indicates the absolute actual position of the reference point. Depending on Pc.1 following representation is possible:</p> <p>When display in increments (Pc.1 = 0 or 1) the displayed value must be multiplied with 10000 Inc. When display in rotations (Pc.1 = 2 or 3) the displayed value is correspond to coplete motor rotations.</p>									

ru.37 Actual position low									
Adr.									
2025h	<input type="checkbox"/>	<input type="checkbox"/>	<input type="checkbox"/>	0	9999 (65535)	1	inc	-	depend on Pc.1

Only active at activated positioning module!!! Indicates with ru.36 the absolute actual position from the reference point. Depending on Pc.1 following representation is possible:









When displayed in increments (Pc.1 = 0 or 1) increments in a range of 0...9999 are displayed.

When displayed in rotations (Pc.1 = 2 or 3) partial rotations in a range of 0...65535 are displayed. (1 rotation = 65535)

ru.38 Set position sign									
Adr.									
2026h	<input type="checkbox"/>	<input type="checkbox"/>	<input type="checkbox"/>	0	1	1	-	-

Only active at activated positioning module!!! Indicates at decimal position display (Pc.1 = 0 or 1) the sign of the setpoint position. At hexadecimal display (Pc.1 = 2 or 3) the parameter is without function.









- 0: Setpoint position in positive direction from the reference point
- 1: Setpoint position in negative direction from the reference point
- 2: Without function since hexadecimal display is selected

ru.39 Set position high									
Adr.									
2027h	<input type="checkbox"/>	<input type="checkbox"/>	<input type="checkbox"/>	0 (-65535)	65535	1	inc	-	depend on Pc.1

Only active at activated positioning module!!! Indicates the absolute setpoint position from the reference point. Depending on Pc.1 following representation is possible:

When display in increments (Pc.1 = 0 or 1) the displayed value must be multiplied with 10000 Inc.

When display in rotations (Pc.1 = 2 or 3) the displayed value is correspond to complete motor rotations.

ru.40 Set position low									
Adr.									
2028h	<input type="checkbox"/>	<input type="checkbox"/>	<input type="checkbox"/>	0	9999 (65535)	1	inc	-	depend on Pc.1

Only active at activated positioning module!!! Indicates with ru.36 the absolute setpoint position from the reference point. Depending on Pc.1 following representation is possible:

When displayed in increments (Pc.1 = 0 or 1) increments in a range of 0...9999 are displayed.

When displayed in rotations (Pc.1 = 2 or 3) partial rotations in a range of 0...65535 are displayed. (1 rotation = 65535)

Fuchntional Description

Adr.			min		max		default	
<input type="checkbox"/>	<input type="checkbox"/>	<input type="checkbox"/>						

In. 4 Software version									
Adr.									
2C04h	<input type="checkbox"/>	<input type="checkbox"/>	<input type="checkbox"/>	0	FFFF	1	-	-
The software version-number of the Host-CPU and the control hardware is encoded in this parameter. 1. digit: C = F4-F 2. and 3. digit: Software version (e.g. 14 = 1.4) 4. digit: Special version (0 = Standard)									

In. 5 Software date									
Adr.									
2C05h	<input type="checkbox"/>	<input type="checkbox"/>	<input type="checkbox"/>	-	-	0,1	-	-
Display of software date. The value incorporates date, month and year, at that only the last number of the year is indicated. Example: Display= 1507.8 Date = 15.07.98									

In. 6 Configfile number									
Adr.									
2C06h	<input type="checkbox"/>	<input type="checkbox"/>	<input type="checkbox"/>	Software	Software	1	-	-
This parameter serves to identify the software that is used on the control by means of KEB COMBIVIS. The configuration is done automatically when COMBIVIS is called and the inverter is connected.									

In. 7	Serial number / date	2C07h							
In. 8	Serial number / counter	2C08h							
In. 9	Serial number / Ackn.-no. high	2C09h							
In.10	Serial number / Ackn.-no. low	2C0Ah							
In.11	Customer number / high	2C0Bh							
In.12	Customer number / low	2C0Ch							
Adr.									
s.a.	<input type="checkbox"/>	<input type="checkbox"/>	<input type="checkbox"/>	0	65535	1	-	0
Serial number and customer number identify the inverter. The QS-number contains internal production information.									

In.40 Last error									
Adr.									
2C28h	<input type="checkbox"/>	<input type="checkbox"/>	<input type="checkbox"/>	0	63	1	-	-

In.40 shows the error that occurred last, E. UP is not stored. The error messages are described under parameter ru.0.

In.41	Error counter OC	2C29h							
In.42	Error counter OL	2C2Ah							
In.43	Error counter OP	2C2Bh							
In.44	Error counter OH	2C2Ch							
In.45 Error counter watchdog 2C2Dh									
Adr.									
s.a.	<input type="checkbox"/>	<input type="checkbox"/>	<input type="checkbox"/>	0	255	1	-	0

The error counters (for E.OC, E.OL, E.OP, E.OH (E.dOH), E.buS) state the total number of the different error types that occurred. The maximum value is 255.

In. 54 Software version DSP									
Adr.									
2C36h	<input type="checkbox"/>	<input type="checkbox"/>	<input type="checkbox"/>	0	FFFF	1	-	-

The software version-number of the control processor and the control hardware is encoded in this parameter.

- 1. digit: C = F4-F
- 2. and 3. digit: Software version (e.g. 14 = 1.4)
- 4. digit: Special version (0 = Standard)

In. 55 Software date DSP									
Adr.									
2C37h	<input type="checkbox"/>	<input type="checkbox"/>	<input type="checkbox"/>	-	-	0,1	-	-

Indicates the software date of the control processor. The value incorporates date, month and year, at that only the last number of the year is indicated.

Example: Display= 1507.8
Date = 15.07.98

In.60	Last error	2C3Ch							
In.61	Last error	2C3Dh							
In.62	Last error	2C3Eh							
In.63	Last error	2C3Fh							
Adr.									
s.a.	<input type="checkbox"/>	<input type="checkbox"/>	<input type="checkbox"/>	-	-	1	-	-

For a better error diagnosis the last 4 errors triggered are displayed.

Chapter 6	Section 1	Page 20	Date 23.10.02	Name: Basis KEB COMBIVERT F4-F	© KEB Antriebstechnik, 2002 All Rights reserved
---------------------	---------------------	-------------------	------------------	--	--

- 1. Introduction
- 2. Summary
- 3. Hardware
- 4. Operation
- 5. Parameter
- 6. Functions**
- 7. Start-up
- 8. Special Operation
- 9. Error Assistance
- 10. Project Planning
- 11. Networks
- 12. Applications
- 13. Annex

- 6.1 Operating and Unit Data
- 6.2 Analog In- and Outputs**
- 6.3 Digital In- and Outputs
- 6.4 Set Value and Ramp Adjustment
- 6.5 Motor Data and Controller Adjustment
- 6.6 Keep on Running Functions
- 6.7 Parameter sets
- 6.8 Special Functions
- 6.9 Encoder Interface
- 6.10 Synchronous Control
- 6.11 Positioning Module
- 6.12 CP-Parameter Definition

- 6.2.1 Brief Description 3
- 6.2.2 Analog Inputs 3
- 6.2.3 Measured value hysteresis 6
- 6.2.4 Interference Suppressor Filter
Analog Inputs 6
- 6.2.5 Gain of Input Characteristic 6
- 6.2.6 Zero Point Hysteresis of
Analog Inputs 9
- 6.2.7 Analog Outputs 10
- 6.2.8 Gain of Output Characteristic 11
- 6.2.9 Used Parameters 14

Chapter 6	Section 2	Page 2	Date 22.10.02	Name: Basis KEB COMBIVERT F4-F	© KEB Antriebstechnik, 2002 All Rights reserved
---------------------	---------------------	------------------	------------------	--	--

6.2 Analog In- and Outputs

6.2.1 Brief Description

The KEB COMBIVERT F4-F incorporates one differential voltage input for setpoint setting (**REF1 ±**), one programmable differential voltage input (**REF2 ±**) and two programmable analog outputs (**A1 / A2**). Depending on the analog input or output signal function, offset and gain can be adjusted.

6.2.2 Analog Inputs

The analog inputs of a digital filter are smoothed by means of averaging. The digital signals are now available for the characteristic amplifiers. In the characteristic amplifier the input signals can be influenced in X- and Y-direction as well as in the gain. To avoid voltage fluctuation and ripple voltages around the zero point the analog signal can be suppressed up to 10 % around the zero point.

Fig. 6.2.1 Diagram of analog inputs

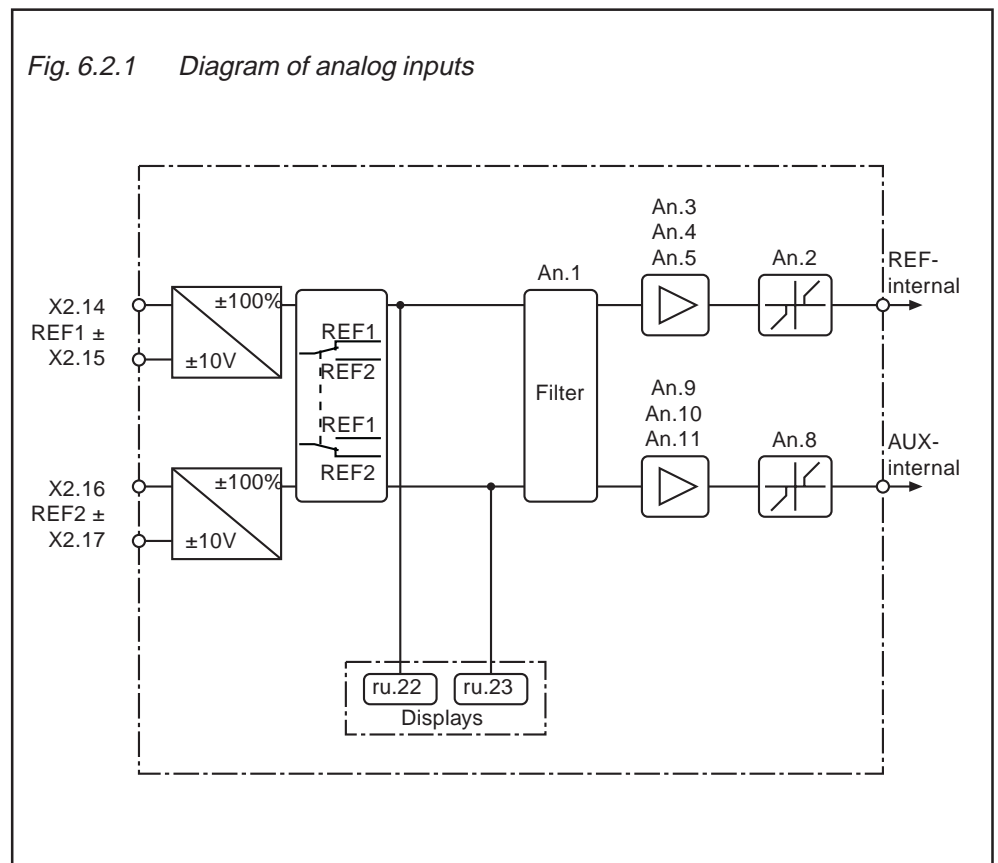

REF1 ↔ REF2 (An.12) The two analog inputs REF1 und REF2 can be exchanged with this parameter.

Control terminal strip X2

Terminal No.	Designation	Function	
12	CRF	+10 V reference voltage	+10V (+/- 3%) ; max. 4 mA
13	COM	Earth for analog inputs/outputs	
14	REF 1 +	REF 1 and REF 2 can be exchanged with parameter An.12	Differential voltage input rpm / Resolution: 12 Bit Ri = 24 kΩ / 40 kΩ scan time: 2ms At fast setpoint input and torque control: 128μs (see chapter 6.5.18)
15	REF 1 -		
16	REF 2 +	Analog setpoint setting, Programmable analog input	
17	REF 2 -		

- Typical circuits** 1. Setpoint setting: External differential voltage **without** internal reference potential. Internal resistance Ri = 40 kΩ

Fig. 6.2.2 Connection **without** internal reference potential

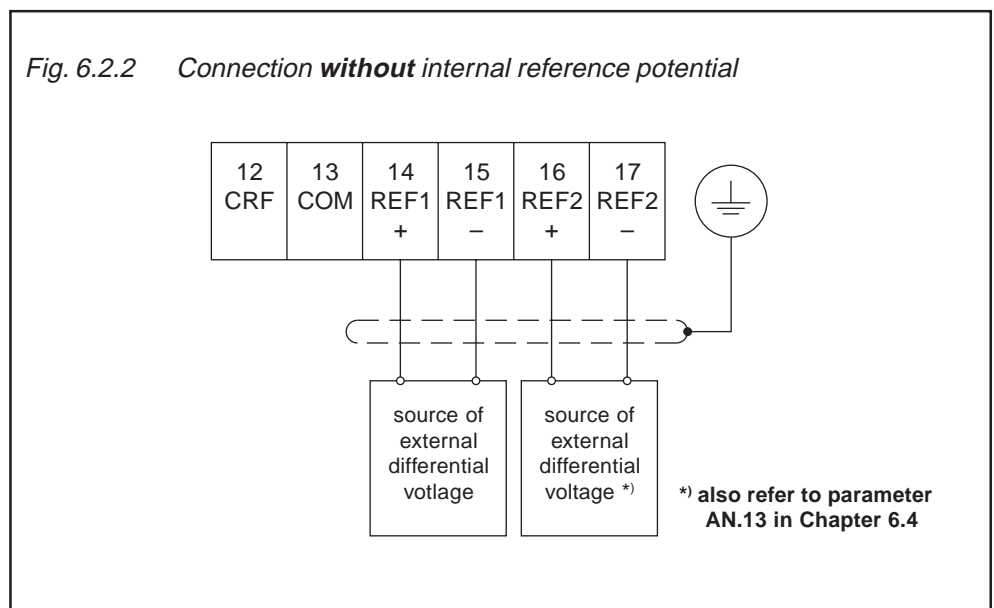

Example: Setpoint = (REF1+) – (REF1-)
 Setpoint = (+7 V) – (+3 V)
 Setpoint = +4 V

2. Setpoint setting: External differential voltage **with** internal reference potential (COM), i.e. REF1- and REF2- are connected to 0V-potential. Thus the differential voltage is always formed between REF+ and COM.

Internal resistance $R_i = 24\text{ k}\Omega$

Example:
 Setpoint = (REF1+) – (REF1-)
 Setpoint = (-7 V) – (0 V)
 Setpoint = -7 V

Fig. 6.2.3 Connection **with** internal reference potential

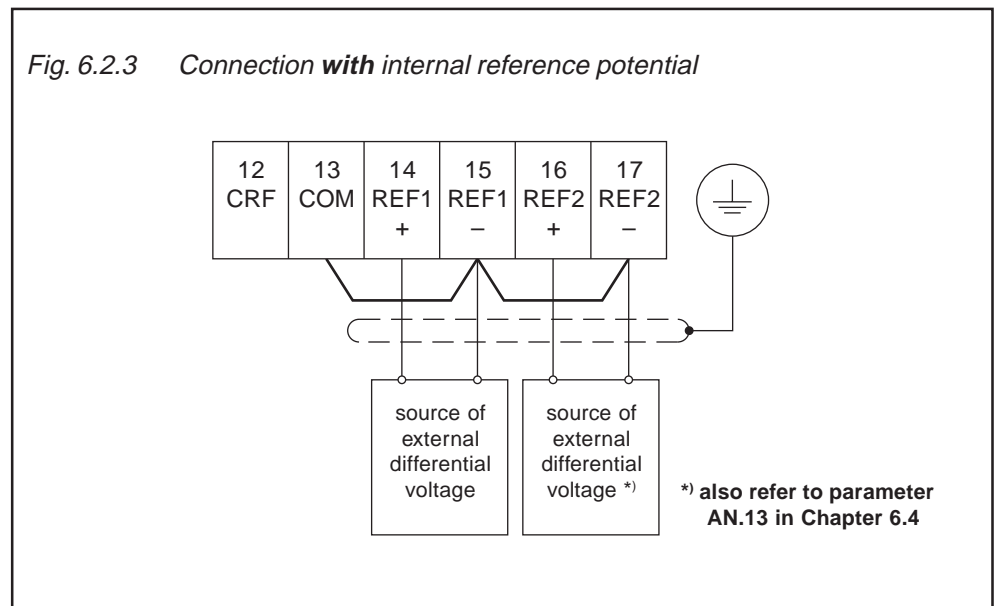

3. Setpoint setting: Internal +10 V reference voltage, i.e. the setpoint can be adjusted from 0...+10 V by means of setpoint potentiometer. Internal resistance $R_i = 24\text{ k}\Omega$

Fig. 6.2.4 Connection with +10 V reference voltage

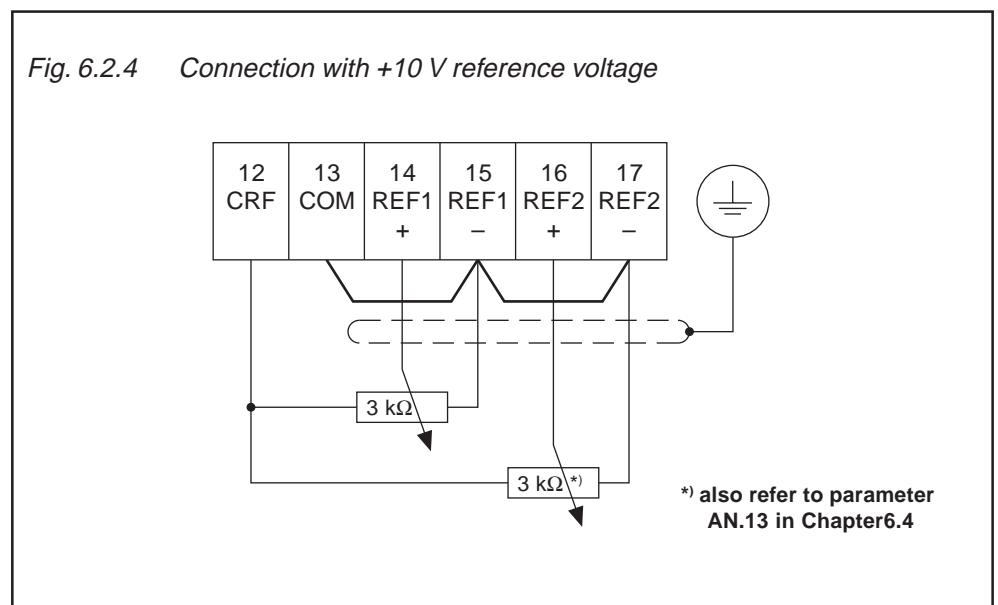

6.2.3 Measured value hysteresis

Input of a hysteresis in % off the analog final value, under which the determined analog value does not change.

6.2.4 Interference Suppressor Filter Analog Inputs (An.1)

The interference suppressor filter shall suppress disturbances and ripple contents of the input signals. Parameter An.1 = 0 means that the interference suppressor filter is deactivated, i.e. the analog inputs are queried every 128 µs, the value registered at that time is passed on.

With An.1 = 1...8 the number of queried measuring values, which are used for averaging, are adjusted. Proportional to the adjusted number of measuring values the averaging time increases.

An.1	Function	Updating time
0 *1	no averaging	128 µs
1 *1	averaging with 2 values	256 µs
2 *1	averaging with 4 values	512 µs
3 *1	averaging with 8 values	1 ms
4 *1	averaging with 16 values	2 ms
5	averaging with 32 values	4 ms
6	averaging with 64 values	8 ms
7	averaging with 128 values	16 ms
8	averaging with 256 values	32 ms
9	averaging with 512 values	64 ms
10	averaging with 1024 values	128 ms

*1) If the direct analog setpoint setting is active (parameter SP.0 = 18) then only the values 0...4 are applicable for parameter An.1. When adjusting higher values (An.1 = 5...8) the internal calculation is done with the value of An.1 = 4.

6.2.5 Gain of Input Characteristic (An.3...5, An.9...11)

As shown in Fig. 6.2.1 the characteristic amplifiers follow upon the interference suppressor filter. With these parameters the input signals can be adapted to the requirements in X- and Y-direction as well as in gain. With factory setting no zero offset is adjusted and the gain is 1, i.e. the input value corresponds to the output value (see Fig. 6.2.5).

The output value is calculated according to following formula:

$$\text{Out} = \text{Gain} \cdot (\text{In} - \text{Offset X}) + \text{Offset Y}$$

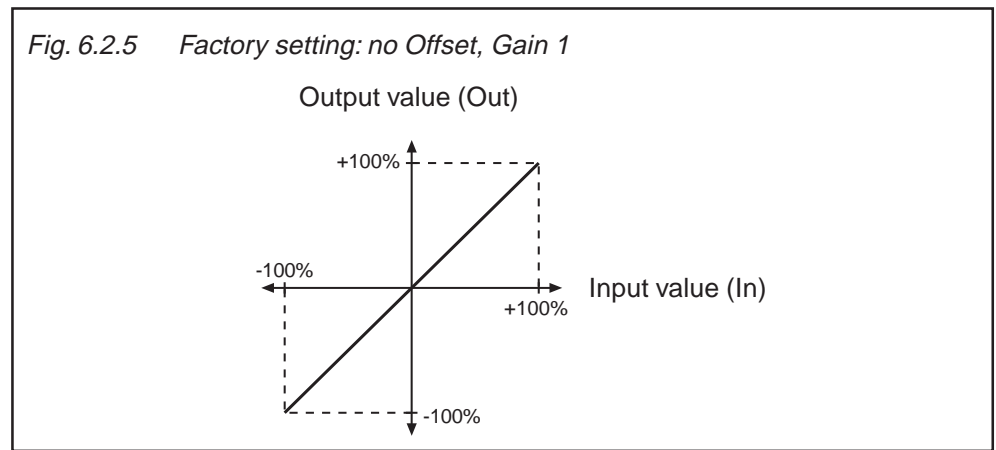

Parameter assignment

Gain	An.3	An. 9	-20...+20	0,01	1,00
X-Offset	An.4	An.10	-100...+100 %	0,1 %	0,0 %
Y-Offset	An.5	An.11	-100...+100 %	0,1 %	0,0 %

Examples By means of some examples we want to demonstrate the possibilities of these functions.

With an voltage (0...10 V) on input REF1 ± the full speed range (-100%...+100%) can be driven (rotation = ±Analog), that means:

0% IN	correspond to	-100% OUT
+50% IN	correspond to	0% OUT
+100% IN	correspond to	+100% OUT

Fig. 6.2.6 Gain (An.3) = 2,00 and X-Offset (An.4) = +50 %, 6

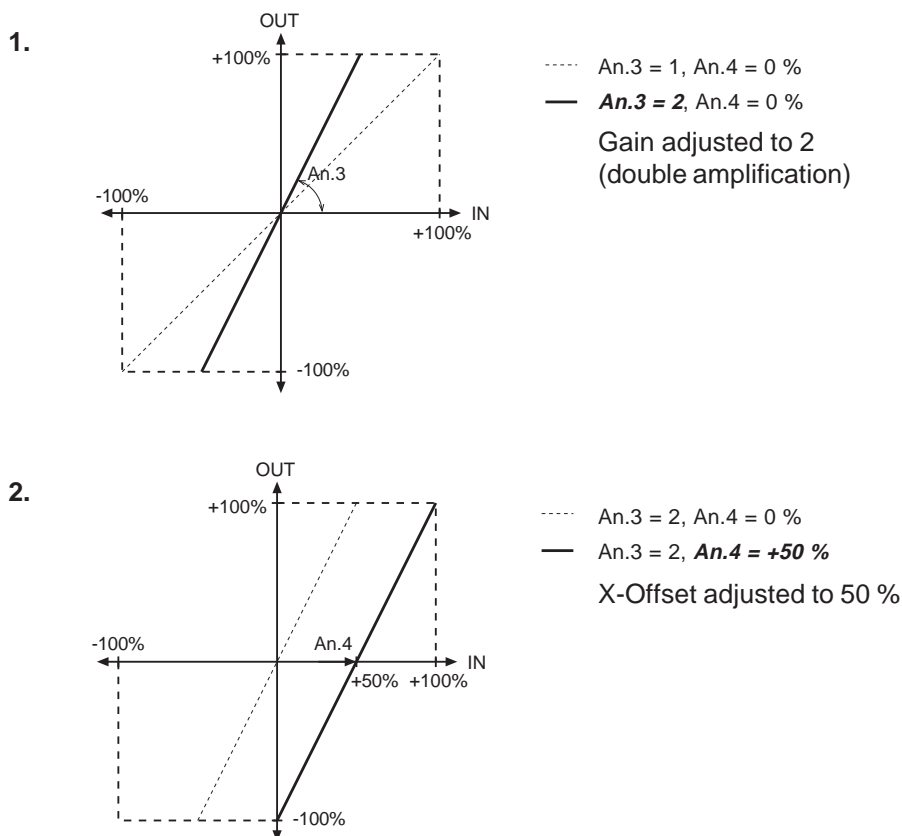

- Example 2: Following values shall be adjusted for the input REF1 ± :
1. Gain adjusted to -1 (single amplification)
 2. X-Offset adjusted to 75 %
 3. Y-Offset adjusted to 100 %

Fig. 6.2.7 Gain (An.3) = -1, X-Offset (An.4) = +75%, Y-Offset (An.5) = +100%

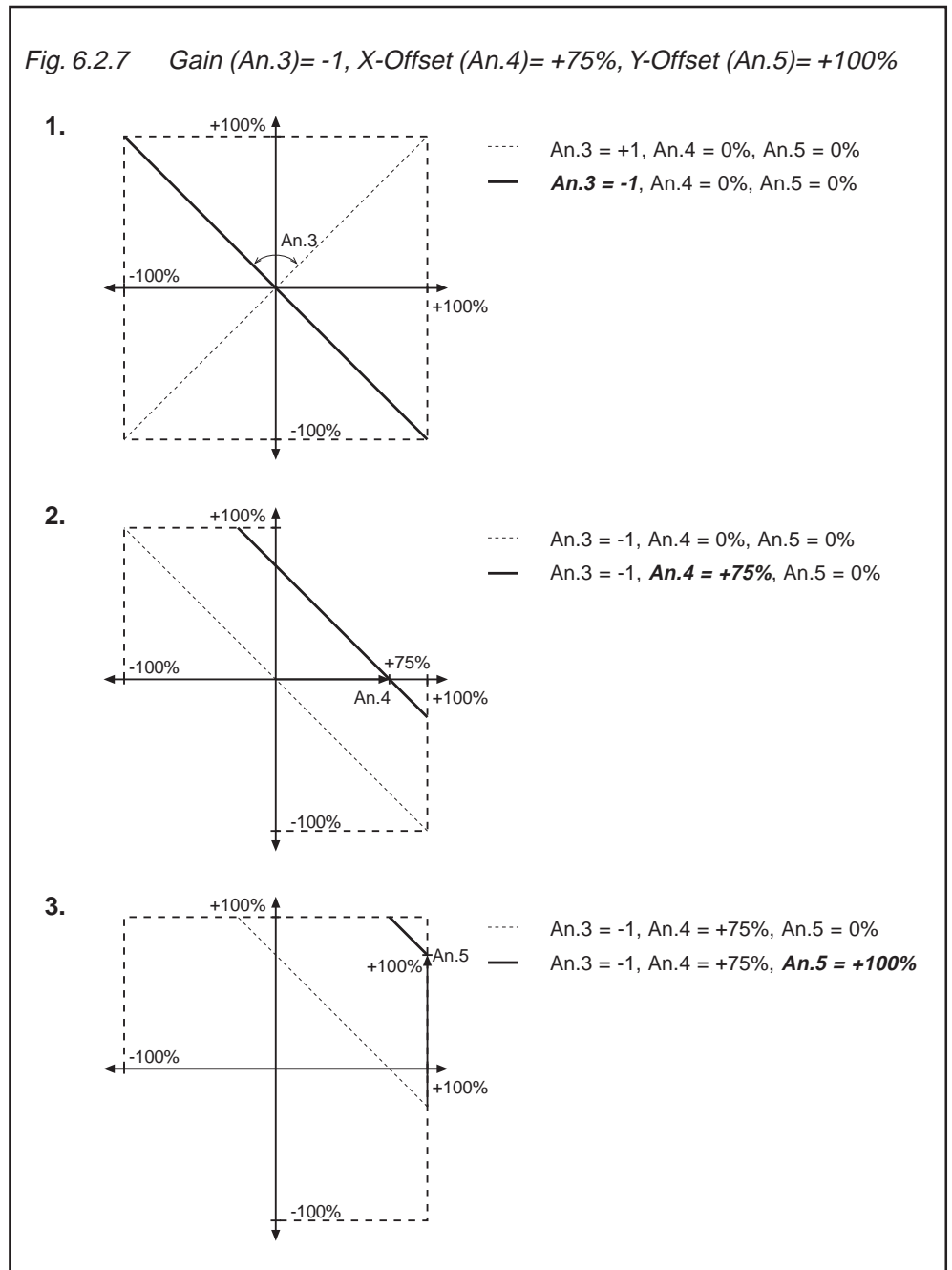

With these settings and inverted setpoint setting in the range of +75...+100 % IN by way of input REF1 ± a speed range of +100...+75% OUT can be driven, that means:

0% IN	correspond to	+100% OUT
+75% IN	correspond to	+100% OUT
+100% IN	correspond to	+75% OUT

To avoid the wrong programming of the analog input signals the IN / OUT adaption should be checked by way of control diagrams (see above).

6.2.6 Zero Point Hysteresis of Analog Inputs (An.2 / An.8)

Through capacitive or inductive coupling onto the input lines or voltage fluctuations of the signal source the motor connected to the inverter may drift in standstill position inspite of analog input filters. It is the task of the zero point hysteresis to suppress this. With the parameters An.2 and An.8 the corresponding analog signals at **the output of the characteristic amplifier** can be suppressed in a range of 0...10%.

For this applies:

0 %	≙	0 rpm
10 %	≙	Maximal speed (SP.5 / SP.7) * 0,1

Fig. 6.2.8 Zero point hysteresis

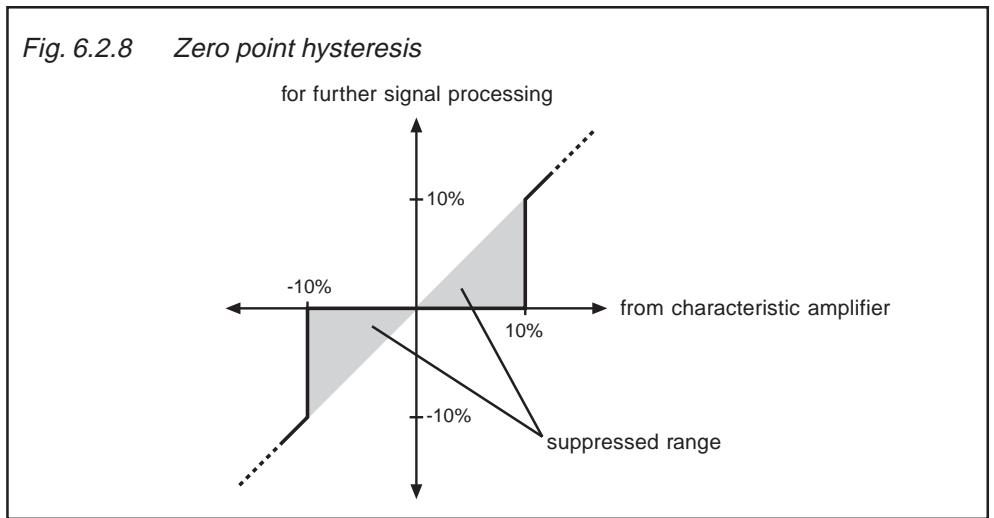

Parameter assignment

Input	Parameter	Value range	Resolution	Default value
REF1	An.2	0...10 %	0,1 %	0,2 %
REF2	An.8	0...10 %	0,1 %	0,2 %

Mode of functioning

This function is provided with a switching hysteresis of 50 %. If the analog signal is larger than the adjusted hysteresis value (An.2 / An.8), then the analog setpoint is active. When the analog signal falls below 50 % of the adjusted hysteresis value, the analog setpoint is set to value 0 . .

Fig. 6.2.9 Zero point hysteresis

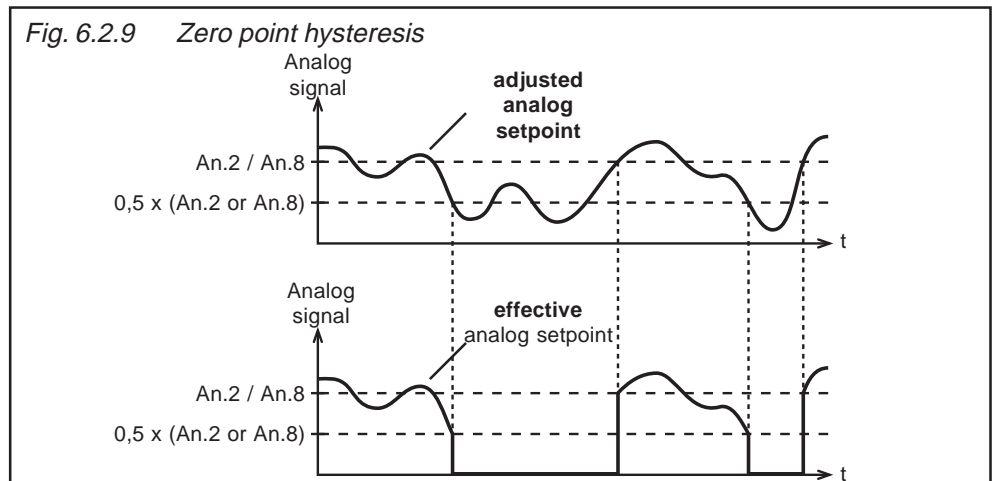

6.2.7 Analog Outputs

The KEB COMBIVERT F4-F has two programmable analog outputs. Parameters An.14 and An.18 allow the selection of one size each which is given out at the control terminal strip X2. By means of the characteristic amplifier the analog signals can be adapted to the requirements.

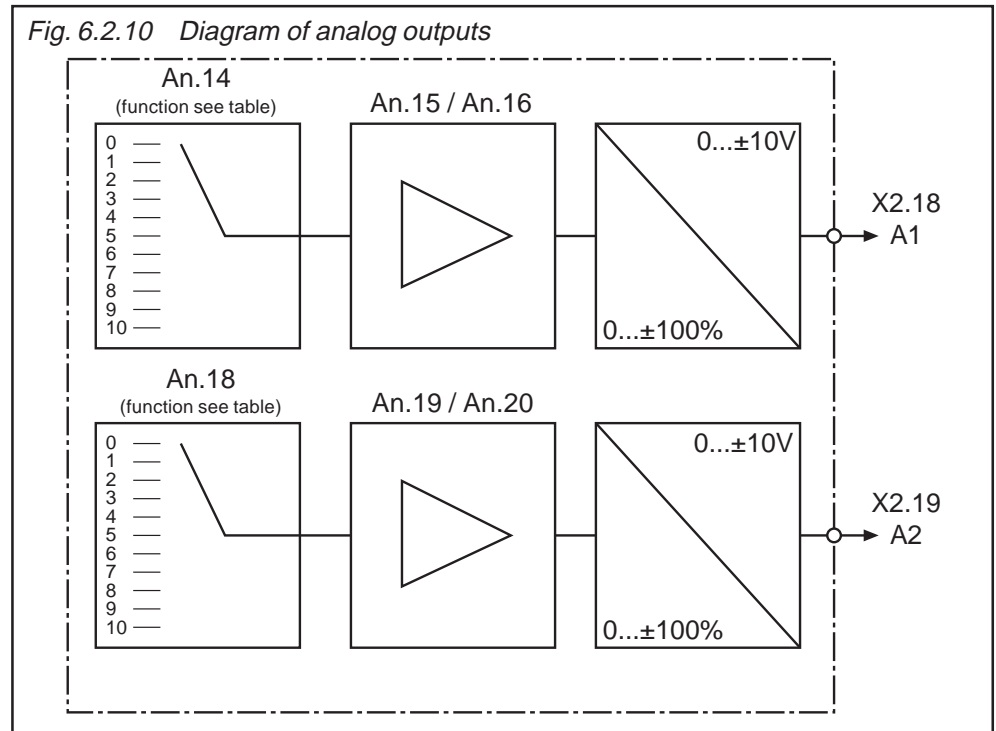

Function analog outputs

An.14 An.18	Function	0...±100% or 0...+100% correspond to
0	actual speed	0...±2 x synchronous speed
1	apparent current	0...2 x rated motor current
2	actual torque	0...±2 x rated torque
3	DC-link voltage	0...1000V
4	speed reference variable (output size of ramp generator)	0...±2 x synchronous speed
5	control difference of the speed controller (speed reference variable – actual speed)	0...±2 x synchronous speed
6	speed controller manipulated variable = torque setpoint	0...±2 x rated torque
7	Modulation depth	0...100%
8	Display of the actual position in a range of (=set pos. in set 0) to 100% (=LE.50...LE.52; LE.53...LE.55)	LE.50...LE.52 for An.14 LE.53...LE.55 for An.18
9	Speed in front of ramp	0...±2 x synchronous speed
10	REF1 output	-10V...+10V

Control terminal strip X2

Terminal No.	Designation	Function	
13	COM	earth for analog inputs/outputs	
18	A1	programmable analog outputs	0...±10 V / Ri = 100 Ω Scan time: 2 ms Resolution: 10 Bit
19	A2		

Typical circuit To visualize different functions voltage meters can be connected to the analog outputs.

Fig. 6.2.11 Connection of analog outputs

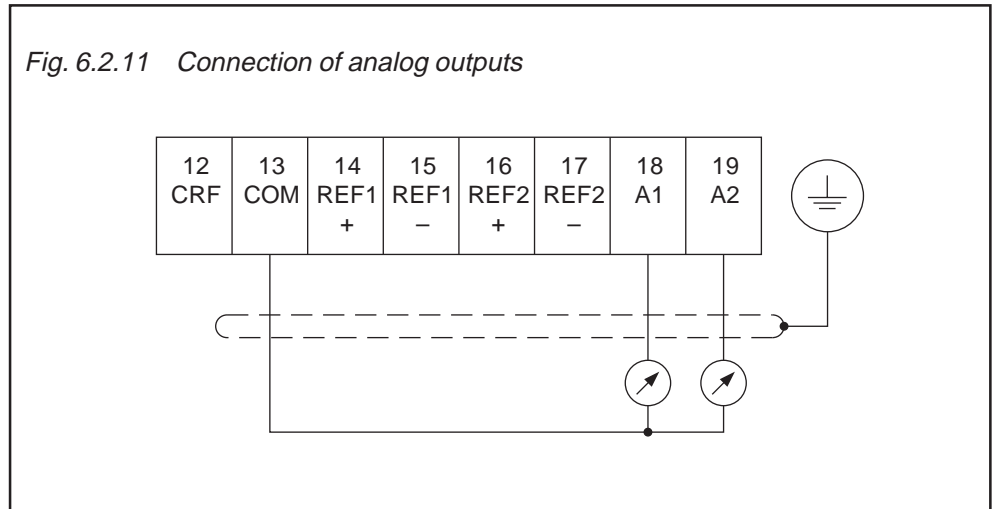

6.2.8 Gain of Output Characteristic (An.15, An.16, An.19, An.20)

After selecting the signal to be given out it can be adapted to the requirements by means of characteristic amplifier in X-direction or gain. With factory setting no zero point offset is adjusted, the gain is 1, i.e. $\pm 100\%$ of the variable to be given out correspond to $\pm 10\text{V}$ at the analog output (see Fig. 6.2.12).

Fig. 6.2.12 Factory setting: no Offset, Gain 1

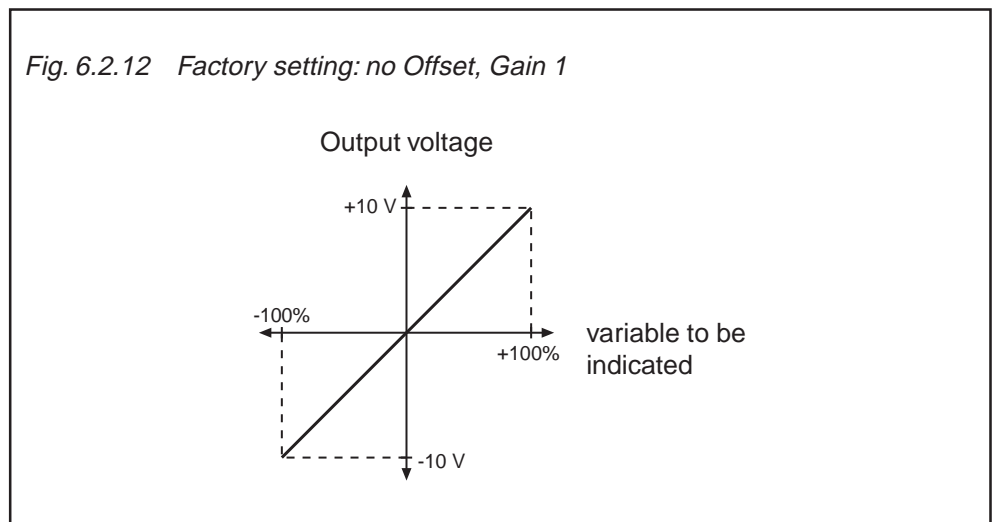

Parameter assignment

Function	A1	A2	Value range	Resolution	Default value
Gain	An.15	An.19	-20...+20	0,01	1,00
X-Offset	An.16	An.20	-100...+100 %	0,1 %	0,0 %

Examples By means of some examples we want to demonstrate the possibilities of these functions.

- Example 1: The following values shall be adjusted for output A1:
1. Gain adjusted to -1 (single amplification)
 2. X-Offset adjusted to 100 %

Fig. 6.2.13 Gain (An.15) = -1,00 and X-Offset (An.16) = 100 %,

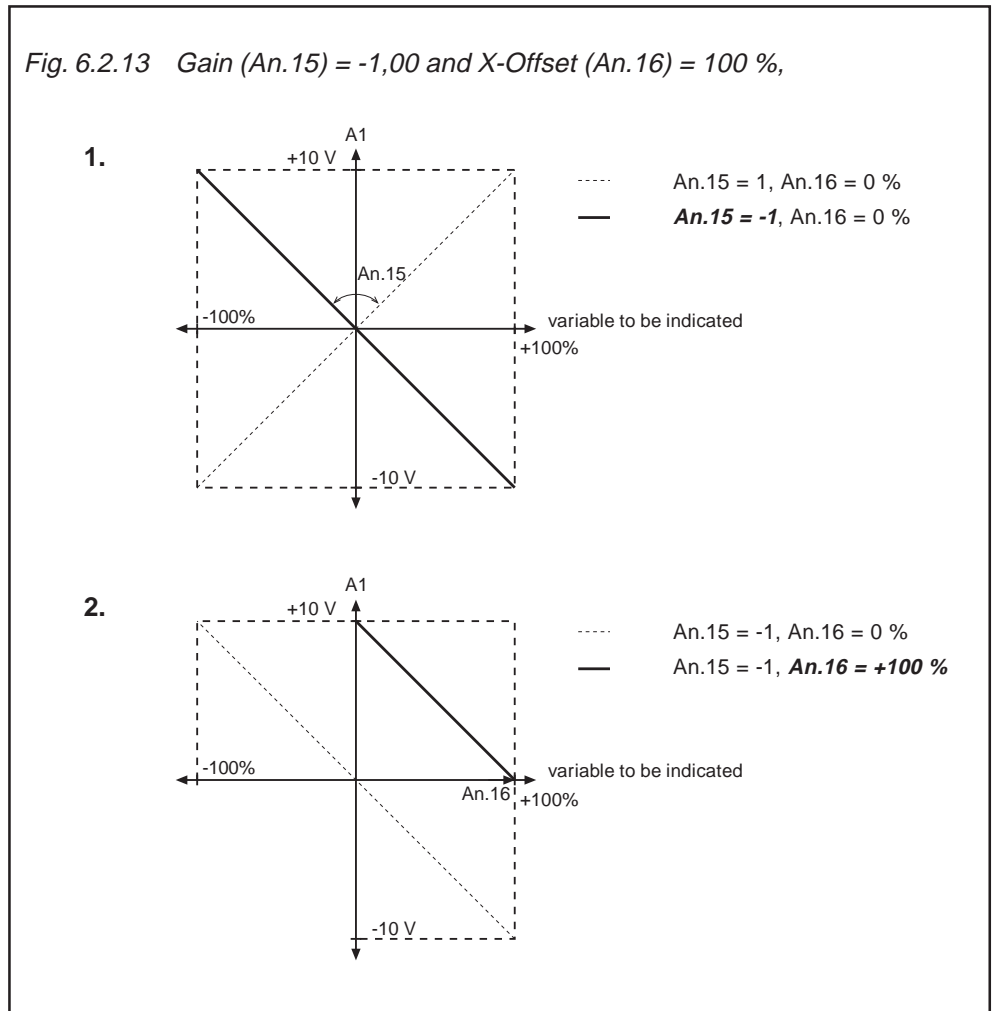

With these settings the analog output A1 is inverted and only reacts to positive values of the variable to be indicated.

This means: 0 % of the variable to be indicated correspond to +10 V at A1
 +50 % of the variable to be indicated correspond to +5 V at A1
 +100 % of the variable to be indicated correspond to 0 V at A1

- Example 2: Following values shall be adjusted for the output A2:
1. Gain adjusted to 20 (-times amplification)
 2. X-Offset adjusted to 25 %

Fig. 6.2.14 Gain (An.19) = 20,00 and X-Offset (An.20) = 25 %,

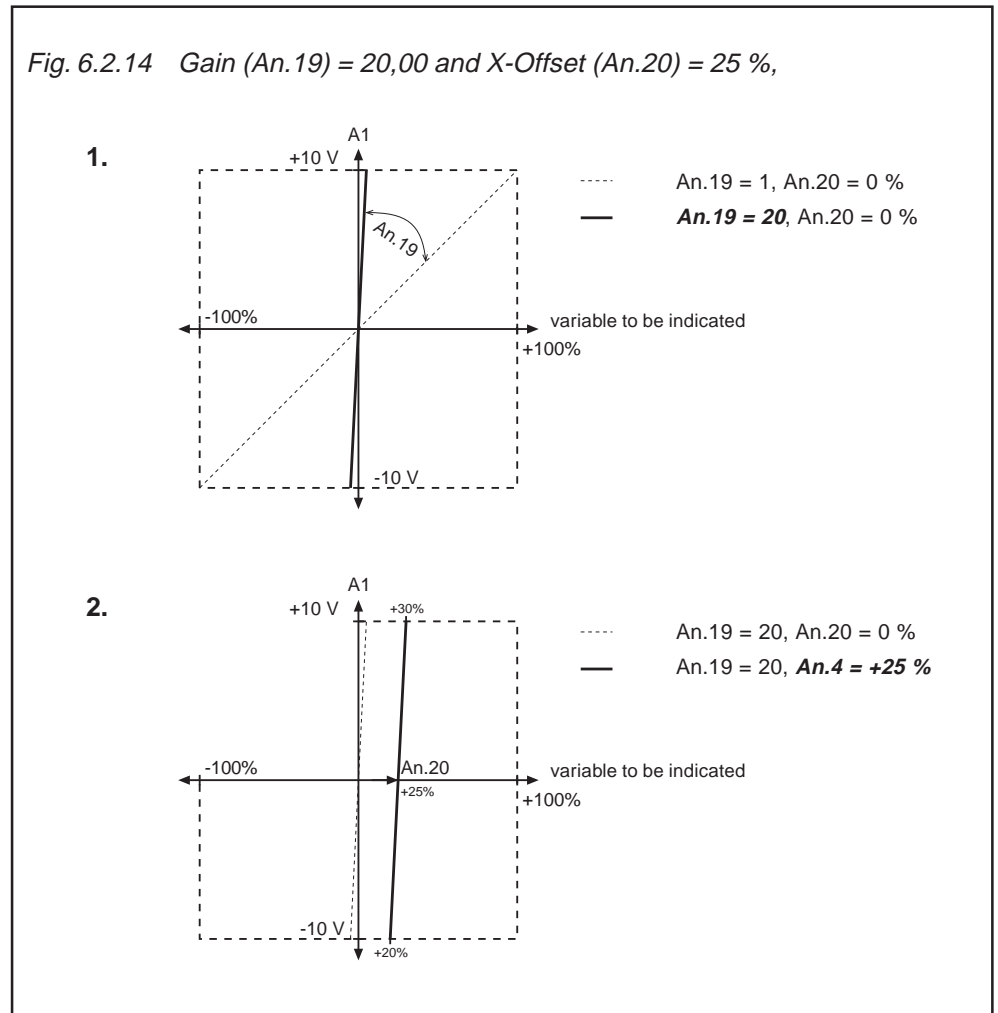

Because of the high adjustment of the gain the change of the output voltage from -10V to +10V takes place within a very small alteration range of the variable to be indicated. Thus the output can be used as „switch“ (HI- and Low-level) for some applications. The adjustment of the X-Offset determines the „switching level“.

This means:

- | | | | |
|------------|---|-------------|-------|
| 0...20 % | of the variable to be indicated correspond to | -10 V | at A2 |
| 20...30 % | of the variable to be indicated correspond to | -10...+10 V | at A2 |
| 30...100 % | of the variable to be indicated correspond to | +10 V | at A2 |

6.2.9 Used Parameters

Param.	Adr.	R/W	PROG.	ENTER	min	max	Step	default	
ru.22	2016h	-	-	-	-100,0 %	100,0 %	0,1 %	-	-
ru.23	2017h	-	-	-	-100,0 %	100,0 %	0,1 %	-	-
An.0	2800h	-	-	-	0,0 %	10 %	0,01 %	0 %	-
An.1	2801h	✓	-	-	0	10	1	3	-
An.2	2802h	✓	-	-	0,0 %	10,0 %	0,1 %	0,2 %	-
An.3	2803h	✓	-	-	-20,00	20,00	0,01	1,00	-
An.4	2804h	✓	-	-	-100,0 %	100,0 %	0,1 %	0,0 %	-
An.5	2805h	✓	-	-	-100,0 %	100,0 %	0,1 %	0,0 %	-
An.8	2808h	✓	-	-	0,0%	10,0 %	0,1 %	0,2 %	-
An.9	2809h	✓	-	-	-20,00	20,00	0,01	1,00	-
An.10	280Ah	✓	-	-	-100,0 %	100,0 %	0,1 %	0,0 %	-
An.11	280Bh	✓	-	-	-100,0 %	100,0 %	0,1 %	0,0 %	-
An.12	280Ch	-	✓	-	0	1	1	0	-
An.13	280Dh	-	-	✓	0	9	1	0	-
An.14	280Eh	✓	✓	✓	0	6	1	2	-
An.15	280Fh	✓	✓	-	-20	20	0,01	1	-
An.16	2810h	✓	✓	-	-100 %	100 %	0,1 %	0 %	-
An.18	2812h	✓	✓	✓	0	6	1	0	-
An.19	2813h	✓	✓	-	-20	20	0,01	1	-
An.20	2814h	✓	✓	-	-100,0 %	100,0 %	0,1 %	0,0 %	-

- 1. Introduction
- 2. Summary
- 3. Hardware
- 4. Operation
- 5. Parameter
- 6. Functions**
- 7. Start-up
- 8. Special Operation
- 9. Error Assistance
- 10. Project Planning
- 11. Networks
- 12. Applications
- 13. Annex

- 6.1 Operating and Unit Data
- 6.2 Analog In- and Outputs
- 6.3 Digital In- and Outputs**
- 6.4 Set Value and Ramp Adjustment
- 6.5 Motor Data and Controller Adjustment
- 6.6 Keep on Running Functions
- 6.7 Parameter Sets
- 6.8 Special Functions
- 6.9 Encoder Interface
- 6.10 Synchronous Control
- 6.11 Positioning Module
- 6.12 CP-Parameter Definition

- 6.3.1 Brief Description
 - Digital Inputs 3
- 6.3.2 Input Signals 3
- 6.3.3 Terminal Status 4
- 6.3.4 Digital Inputs set by Software . 4
- 6.3.5 Digital Filter 5
- 6.3.6 Inverting of Inputs 5
- 6.3.7 Strobe-Dependent Inputs 5
- 6.3.8 Function Assignment 7
- 6.3.9 Input Status 8
- 6.3.10 Brief Description
 - Digital Outputs 9
- 6.3.11 Output Signals 10
- 6.3.12 Switching Conditions 10
- 6.3.13 Output Filter Unit 12
- 6.3.14 Inverting of Switching Conditions 14
- 6.3.15 Selection of Switching Conditions 14
- 6.3.16 Logic Operation of Switching Conditions 14
- 6.3.17 Inverting of Outputs 15
- 6.3.18 Output Terminal Status 15
- 6.3.19 Used Parameters 16

Chapter 6	Section 3	Page 2	Date 23.10.02	Name: Basis KEB COMBIVERT F4-F	© KEB Antriebstechnik, 2002 All Rights reserved
---------------------	---------------------	------------------	------------------	--	--

6.3 Digital In- and Outputs

6.3.1 Brief Description Digital Inputs

! For safety reasons the control release (ST) must generally be operated by hardware. Edge triggering and strobe signal can be adjusted but have no effect.

The KEB COMBIVERT F4-F has 7 external digital inputs, 6 of these inputs are programmable (I1...I6). In addition to that the unit has 4 internal programmable inputs (IA...ID), which are directly linked with the internal outputs. Coming from the terminal strip it can be defined with parameter dr.1 whether the inputs are triggered in PNP or NPN circuits. Parameter ru.14 shows the actually activated terminals. Each input can be set optionally (di.15) by way of terminal strip or by software with di.16. A digital filter (di.0) reduces the interference susceptibility of the inputs. With di.2 the inputs can be inverted. With the parameters di.17...di.19 a strobe mode can be activated. The input status (ru.16) indicates the inputs that are actually set for processing. The function, which is performed by a programmable input, is defined with di.3...di.6, di.11 and di.12. The internal inputs are directly controlled by the internal outputs. Their function is defined with di.7...di.10.

Fig. 6.3.1 Diagram of digital inputs

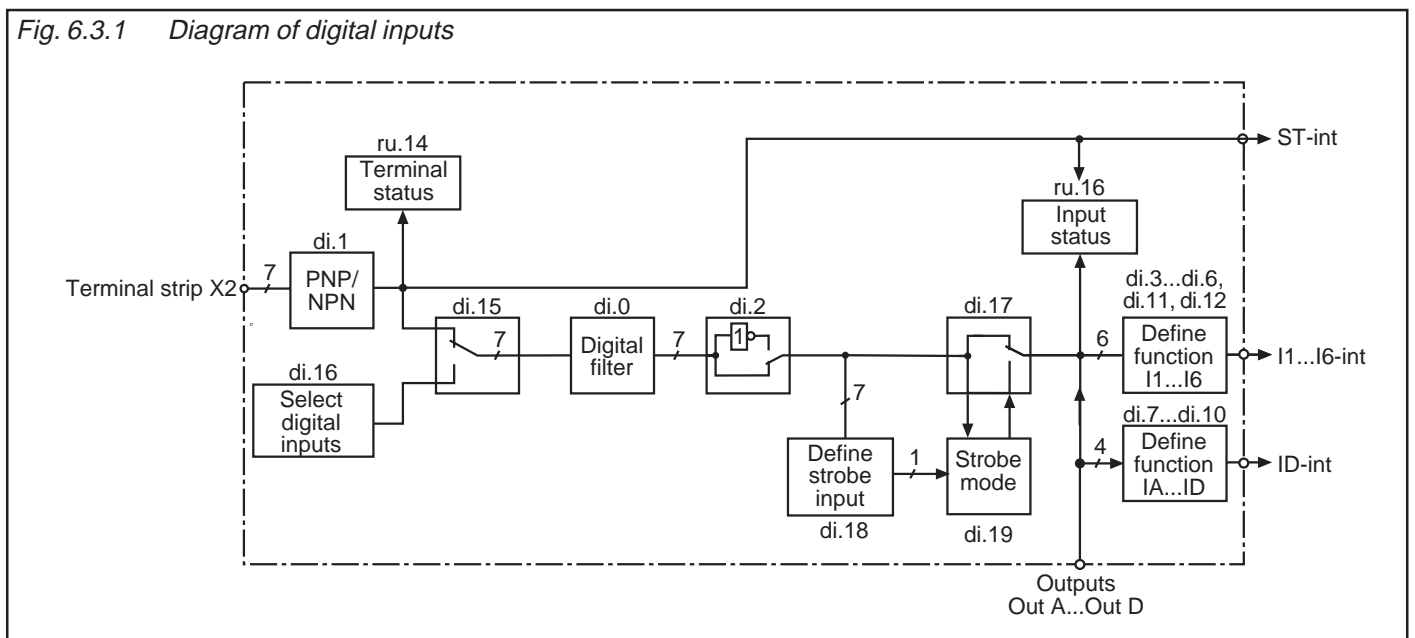

6.3.2 Input Signals PNP / NPN (di.1)

Fig. 6.3.2.a Digital inputs with PNP-control (di.1 = 0)

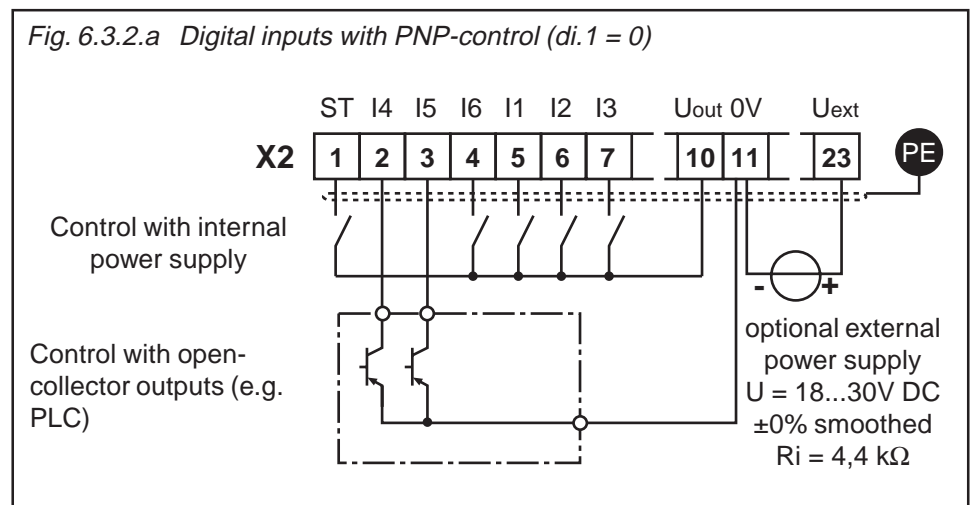
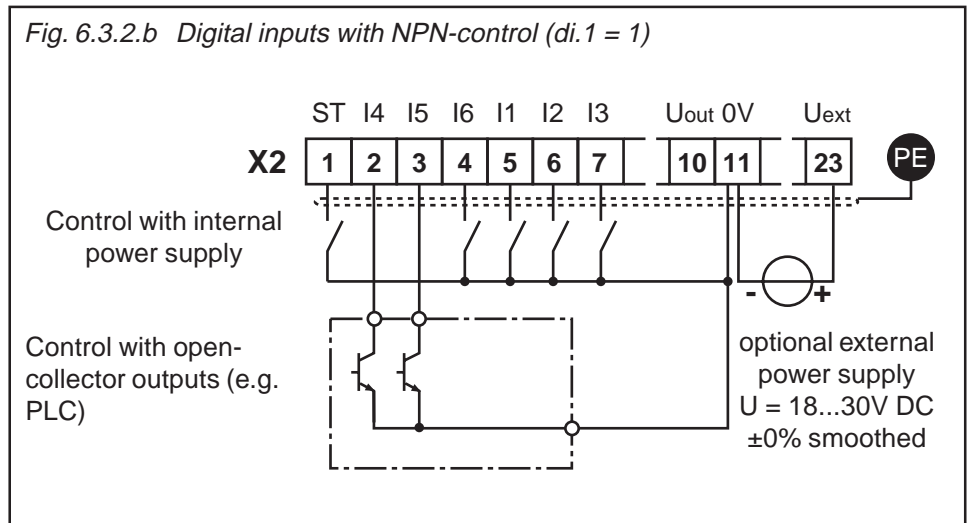

Fig. 6.3.2.b Digital inputs with NPN-control (di.1 = 1)



6.3.3 Terminal Status (ru.14)

The terminal status shows the logical state of the input terminals. At that it is irrelevant whether the inputs are internally active or not. If one terminal is triggered, the corresponding decimal value as listed in the table below is displayed. If several terminals are active then the sum of the decimal value is displayed.

Terminal	Name	Function	Decimal Value
X2.1	ST	control release	1
X2.2	I4	prog. input 4 (reset)	2
X2.3	I5	prog. input 5 (forward)	4
X2.4	I6	prog. input 6 (reverse)	8
X2.5	I1	prog. input 1	16
X2.6	I2	prog. input 2	32
X2.7	I3	prog. input 3	64

Example: ST and I5 are triggered ⇨ displayed value = 1+4 = 5

6.3.4 Digital Inputs set by Software (di.15, di.16)

With parameters di.15 and di.16 digital inputs can be set without external wiring.

! The control release must generally be operated by hardware, even if the actuation is done by software (see Fig. 6.3.4 AND operation).

Fig. 6.3.4 Digital inputs set by software (di.15/di.16)

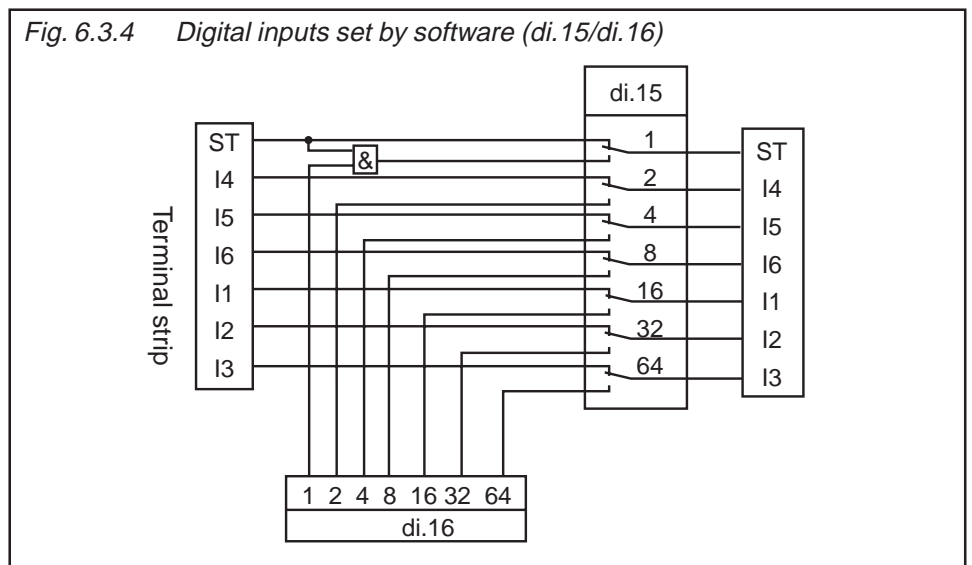

As shown in Fig. 6.3.4 with parameter di.15 you can adjust that the inputs are actuated by the terminal strip (standard) or by way of parameter di.16. Both parameters are bit-coded, i.e. according to following table the value belonging to the input must be entered. In case of several inputs add up the sum. (Exception: Control release must always be bridged at the terminal strip.)

Terminal	Name	Function	Decimal Values di.15 and di.16
X2.1	ST	(control release)	1
X2.2	I4	(prog. input 4)	2
X2.3	I5	(prog. input 5)	4
X2.4	I6	(prog. input 6)	8
X2.5	I1	(prog. input 1)	16
X2.6	I2	(prog. input 2)	32
X2.7	I3	(prog. input 3)	64

6.3.5 Digital Filter (di.0)

The digital filter reduces the sensitivity against interferences on the digital inputs. The response time is adjusted with di.0. For the duration of the adjusted time the status of **all** inputs must remain constant, in order for an acceptance to take place. **Control release is not evaluated!**

Parameter	Setting Range
di.0	0,0...20,0 ms

6.3.6 Inverting of Inputs (di.2)

With parameter di.2 it is adjusted whether a signal is 1- or 0-active (inverted). The parameter is bit-coded, i.e. according to following table the value belonging to the input must be entered. If several inputs shall be inverted add up their sum. (Exception: Inverting of the control release is without function.)

Terminal	Name	Function	Decimal Values di. 2
X2.1	ST	(control release)	1
X2.2	I4	(prog. input 4)	2
X2.3	I5	(prog. input 5)	4
X2.4	I6	(prog. input 6)	8
X2.5	I1	(prog. input 1)	16
X2.6	I2	(prog. input 2)	32
X2.7	I3	(prog. input 3)	64

6.3.7 Strobe-Dependent Inputs (di.17...di.19)

In most cases the strobe signal is used to trigger the input signals. For example, two inputs shall serve for the parameter set selection. But the signals for the actuation do not come equally, so for a short time the changeover to an unintended set would take place. At active strobe the actual input signals of the strobe-dependent inputs are accepted and maintained until the next scanning.

Which inputs are actuated by strobe?

With di.17 every input can be selected as strobe-dependent input. For the control release di.17 has no effect, as it is a static input.

Where is the strobe signal coming from?

With parameter di.18 every input can be adjusted as strobe input **in addition** to its programmable function. If several inputs are adjusted as strobe they are **OR-operated**. At the next rising edge from the program cycle the strobe signal is triggered.

di.17 Strobe-dependent inputs
di.18 Selection of strobe signal

Terminal	Name	Function	Decimal Values di.17 and di.18
X2.1	ST	control release	1 (without function)
X2.2	I4	prog. input 4	2
X2.3	I5	prog. input 5	4
X2.4	I6	prog. input 6	8
X2.5	I1	prog. input 1	16
X2.6	I2	prog. input 2	32
X2.7	I3	prog. input 3	64
-	IA	internal input A	256
-	IB	internal input B	512
-	IC	internal input C	1024
-	ID	internal input D	2048

Edge-active or static strobe?

As a standard the strobe is edge-active, i.e. the input states are accepted with the rising edge and maintained until the next edge. In some cases, however, it may be sensible to use the strobe in a manner of a Gate-function. In such cases the strobe signal is static, i.e. the input signals are accepted for as long as the strobe signal is set.

di.19 Strobe-mode

Parameter	Setting Range	Function
di.19	0	edge-active strobe (see Fig. 6.3.7.a)
	1	static strobe (see Fig. 6.3.7.b)

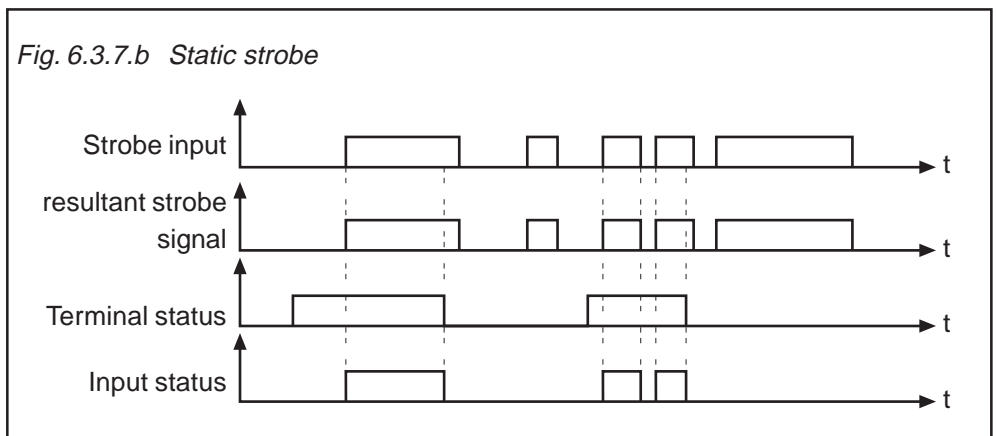
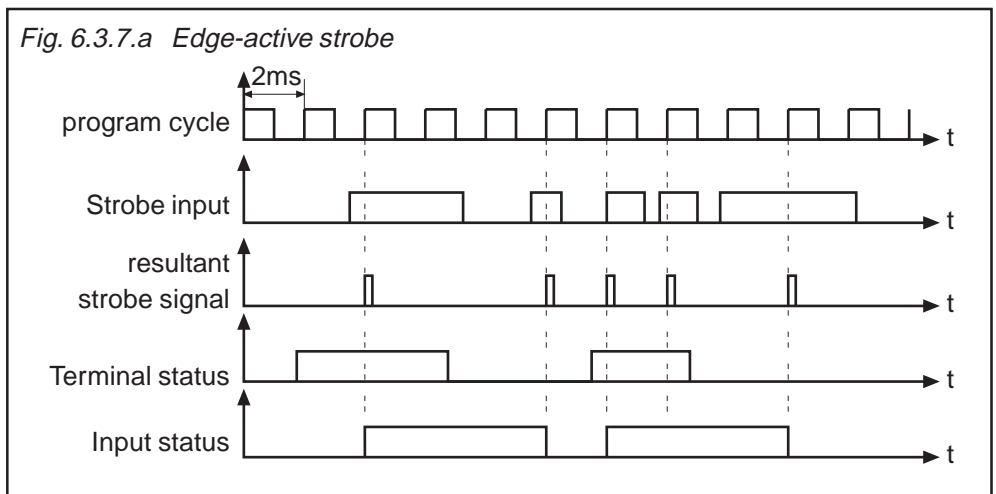

6.3.8 Function Assignment (di.3...di.12)

With the following parameters the desired functions are assigned to the programmable inputs I1...I6 and the internal inputs IA...ID.

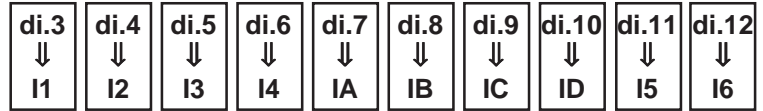

Following table lists the possible functions and the matching decimal values. To adjust a function the decimal value of the parameter must be set.

di.3...di.12	Function
0	no function
1	parameter set selection
2	reset to set 0 for input-coded parameter set selection
3	to trip an external error
4	jogging clockwise rotation
5	jogging counter-clockwise rotation
6	resetting of angular displacement
7	position correction of slave positive (only synchronous module)
8	position correction of slave negative (only synchronous module)
9	to deactivate synchronous control (only synchronous module)
10	reference point operation clockwise rotation
11	reference point operation counter-clockwise rotation
12	reference point switch
13	motorpotentiometer - increase value (see „Motorpoti“)
14	motorpotentiometer - decrease value (see „Motorpoti“)
15	Reset ¹⁾
16	rotation forward
17	rotation reverse
18	limit switch both directions (no reference point operation possible)
19	start positioning (only positioning module)
20	rotation forward and reference point switch
21	rotation reverse and reference point switch
22	positoning deactivated (only positioning module)
23	posi-latch (refer to ru.58...ru.60)
24	posi-teach-in of positions is now possible via Pd.01 = 3 or digital input
25	posi-abort (see 6.11.9)
26	resetting of motor-poti

¹⁾ If no input is programmed to function Reset then a Reset is automatically triggered upon opening the control release (if an error exists). When one input has the function Reset, then it is not possible to reset with the control release.

If the input function 9: Synchronous off is programmed on the inputs I1 or I2 or I3, it is scanned in 128 µs.

The input function 25 : posi-abort onla responds on the inputs I1/ I2/ I3, since it must be scanned quickly.

6.3.9 Input Status (ru.16) The input status shows the logic state of the digital inputs which are set internally to further processing. At that it is irrelevant whether the external terminals are active or not. If an input is set the corresponding value according to the following table is displayed. If several inputs are set then the sum of the decimal values is displayed.

Terminal	Name	Function	Decimal Value ru.16
X2.1	ST	control release	1
X2.2	I4	prog. input 4	2
X2.3	I5	prog. input 5	4
X2.4	I6	prog. input 6	8
X2.5	I1	prog. input 1	16
X2.6	I2	prog. input 2	32
X2.7	I3	prog. input 3	64
-	IA	internal input A	256
-	IB	internal input B	512
-	IC	internal input C	1024
-	ID	internal input D	2048

Example: ST and I5 are triggered ⇒ displayed value = 1+4 = 5

6.3.10 Brief Description - Digital Outputs

Fig. 6.3.10 Diagram of digital outputs

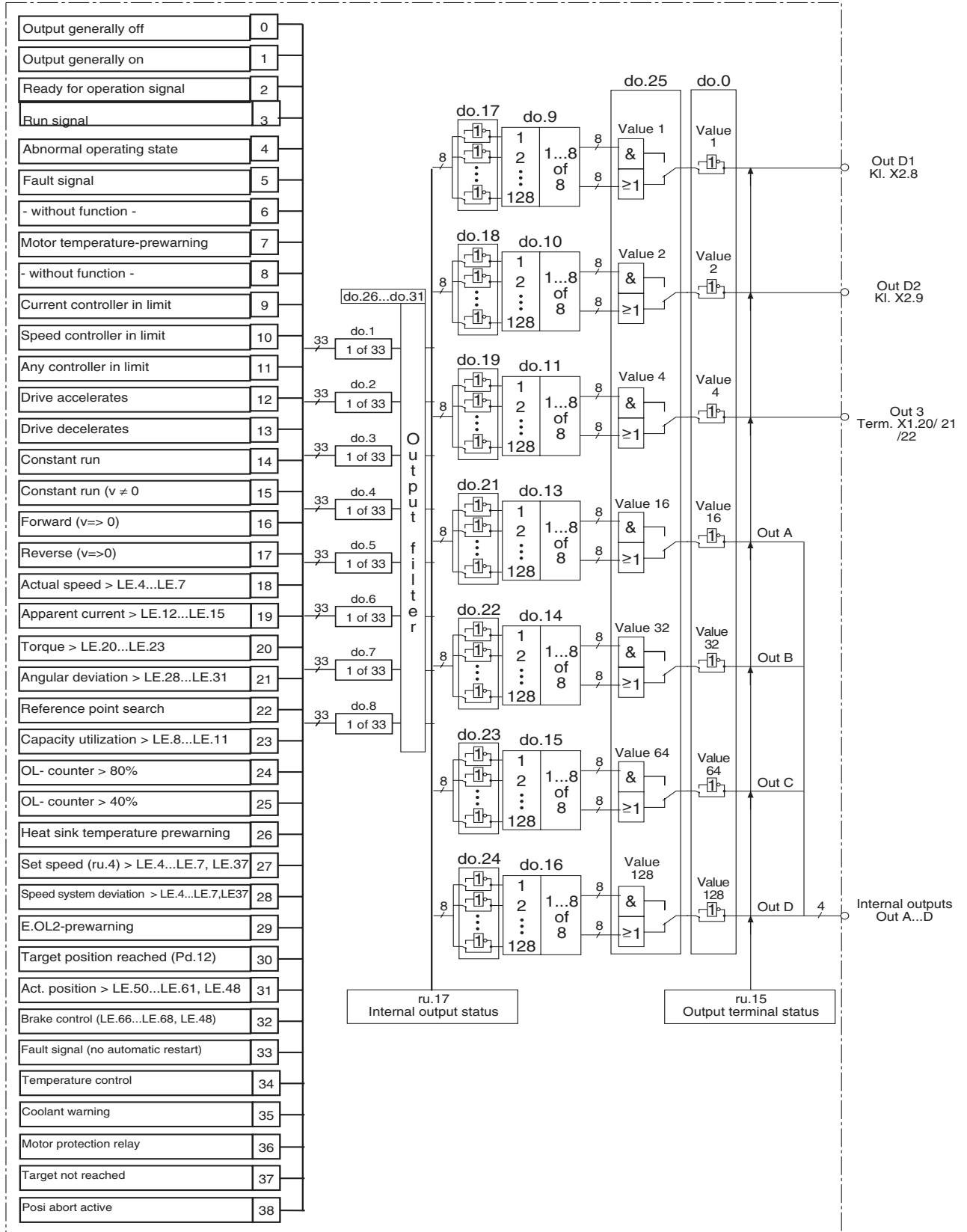

11	*1	Optional controller in the limit
12	*2	Drive accelerates
13	*2	Drive decelerates
14	*2	Drive operates with constant speed
15	*2	Drive operates uneven 0 with constant speed
16	*3	Clockwise rotation (forward); not at noP, LS, abnormal stopping or fault
17	*3	Counter clockwise rotation (reverse); not at noP, LS, abnormal stopping or fault
18		Actual speed (ru.1) > speed level 1...4 adjusted in LE.4...LE.7. Speed level 1 applies to do.1 and do.5, speed level 2 applies to do.2 and do.6...and so forth.; LE.37 defines the speed hysteresis.
19		Apparent current (ru.9) > apparent current level 1...4 adjusted in LE.12...LE.15. Apparent current level 1 applies to do.1 and do.6, apparent current level 2 applies to do.2 and do.6 ...and so forth.; LE.38 defines the current hysteresis.
20	*1	Torque (ru.2) > torque level 1...4 adjusted in LE.20...LE.23. Torque level 1 applies to do.1 and do.5; torque level 2 applies to do.2 and do.6 ...and so forth.; LE.40 defines the hysteresis.
21		Angular displacement (ru.27) > angular level 1...4 adjusted in LE.28...LE.31. Angular level 1 applies to do.1 and do.5, angular level 2 applies to do.2 and do.6 ...and so forth.; LE.39 defines the angular hysteresis.
22		Reference point run completed
23		Load (ru.7) > than the load level 1...4 adjusted in LE.8...LE.11. Load level1 applies to do.1 and do.5; load level 2 applies to do.2 and do.6 ...and so forth.
24		Overload-signal 80%! ru.24 is an overload counter that counts in steps of 1%. At 100% the inverter switches off with E.OL. At 80% the output is set.
25		Overload-signal 40%! ru.24 is an overload counter that counts in steps of 1%. At 100% the inverter switches off with E.OL. At 40% the output is set.
26		Overtemperature-signal is set, when the heat sink temperature exceeds 70...90°C depending on the power stage. In case the temperature does not drop below the tripping level it is being switched off with error E.OH 10 s after setting the output.
27		Setpoint speed (ru.4) > than the speed level 1...4 adjusted in LE.4...LE.7. Speed level 1 applies to do.1 and do.5, speed level 2 applies to do.2 and do.6...and so forth.; LE.37 defines the speed hysteresis.
28	*1	Speed controller deviation (ru.28) > than the speed level 1...4 adjusted in LE.4...LE.7. Speed level 1 applies to do.1 and do.5, speed level 2 applies to do.2 und do.6...usw.; LE.37 defines the speed hysteresis.
29		Constant current exceeded at low speed (warning); The OL2 function is dependent of the heat sink teperature. The prewarning is set if the the load is so high that E.OL2 is triggered at max. heat sink temperature.
30		Target window reached ; is set, when after giving a positioning command the actual position equals the setpoint position. The tolerance defined by the target window (Pd.12). Only available in positioning operation (Sn.0 = 0; Pc.0 = 1). Attention! If a new positioning command is started the signal remains set during the brake release time.
31		Actual position > than the positioning level 1...4 adjusted in LE.50...LE.61. Positioning level 1 applies to do.1 and do.5; positioning level 2 applies to do.2 and do.6 ...and so forth.; LE.48 defines the hysteresis.
32		Brake control ; by selecting this switching condition the function „brake handling“ (see chapter 6.8) is activated. Depending on the operating state of the inverter and the brake parameters LE.66...LE.68 a signal is generated for the brake control.
33		Fault signal ; Inverter has disabled the modulation after an error or fast stop and automatic restart is not activated for the respective error (Pn.0 or Pn.1).
34		Temperature control for water-cooled inverter (see chapter 6.8.6 Temperature Control) Attention! This function should only be used via transistor output with the respective following electronics.
35		Coolant warning for water cooled inverter (see chapter 6.8.6 Temperature Control)
36		motor protective relay, output set, if the motor protection condition (see Pn.03) is not active
37		target not reached (see chapter 6.11.11)
38		posi abort active (see chapter 6.11.11)

*1 Function available only for controlled operation.

*2 This function refers to the setpoint ramps only, i.e. if the ramp generator has not been passed (e.g. in case of fast setpoint setting, activated synchronous controller or positioning controller) then the function is not available. If the drive cannot follow the adjusted ramps, then the output switches in dependence on the setpoint value and not the actual value.

©	KEB Antriebstechnik, 2002 All Rights reserved	Name: Basis KEB COMBIVERT F4-F	Date 23.10.02	Chapter 6	Section 3	Page 11
---	--	--	------------------	---------------------	---------------------	-------------------

6.3.13 Output Filter Unit (do.26...do.31)

Fig. 6.3.13 Function chart of output filters

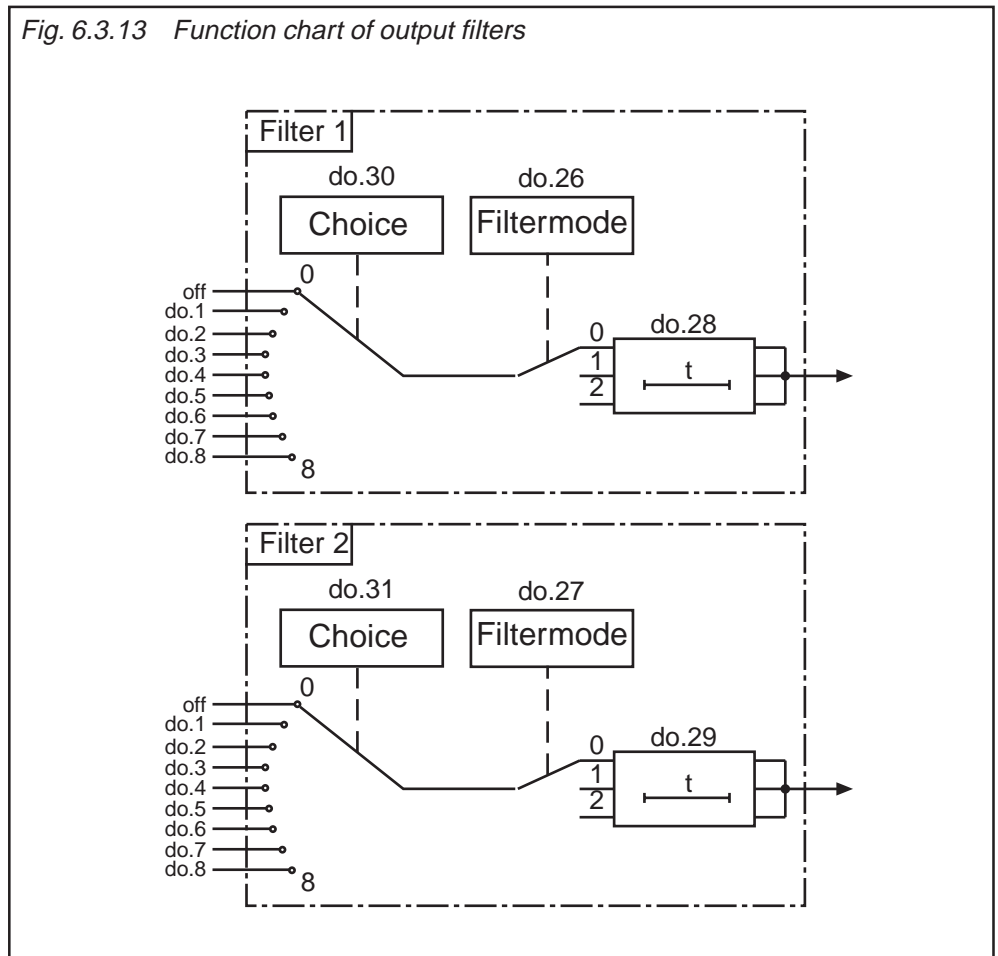

The output filter unit consists of two digital filters independent of each other. Each of the filter can be assigned to any selected switching condition.

Logic operation of output filters (do.30, do.31)

For that the parameters do.30 and/or do.31 are adjusted to the condition to be filtered as follows:

Value	Function of do.30 / do.31
0	none
1	switching condition 1 (do.1)
2	switching condition 2 (do.2)
3	switching condition 3 (do.3)
4	switching condition 4 (do.4)
5	switching condition 5 (do.5)
6	switching condition 6 (do.6)
7	switching condition 7 (do.7)
8	switching condition 8 (do.8)

Filter time (do.28, do.29)

The entered value defines the time with which, depending on the selected mode, the evaluation is done (see example) The filter time is calculated as follows:

$$\text{Adjusted value (0...488)} * \text{scan time (2,048ms)} = \text{0...999ms}$$

In COMBIVIS the input is done directly in ms and is rounded off accordingly.

Adjustment of filter mode (do.26, do.27)

To optimally adjust the filter to interference sources, different modes can be selected with do.26 or do.27:

Value	Function of do.26 / do.27
0	The filter output changes only if during the entire filter time (do.28/do.29) a constant signal was applied to the filter input.
1	An average is formed over the adjusted filter time (do.28/do.29)
2	The filter output is set if during the entire filter time (do.28/do.29) a constant signal was applied to the filter input. The filter output is immediately reset as soon as the input signal is no longer available.

Example filter mode 0

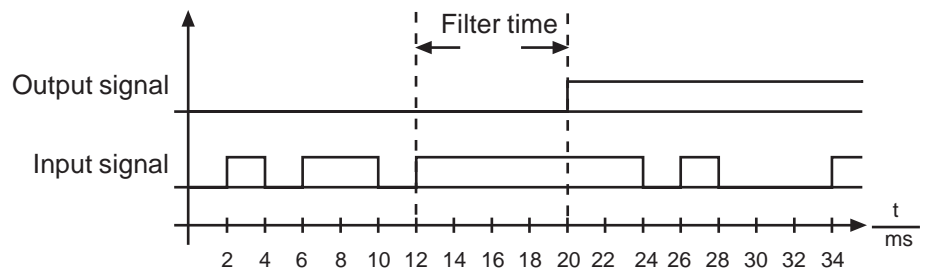

Example filter mode 1

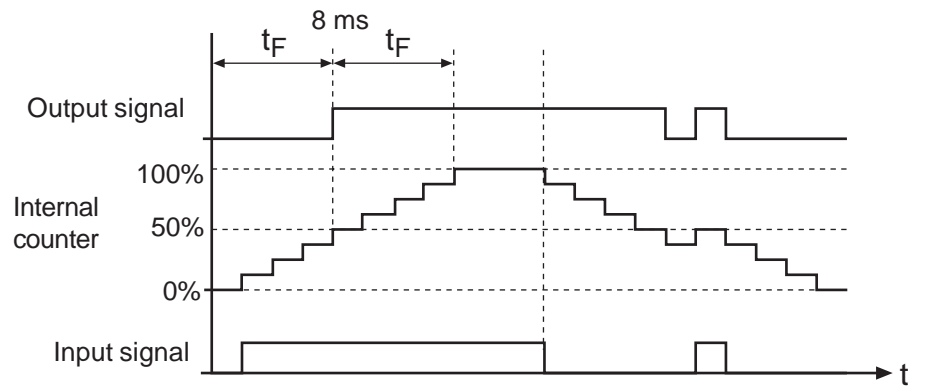

Example filter mode 2

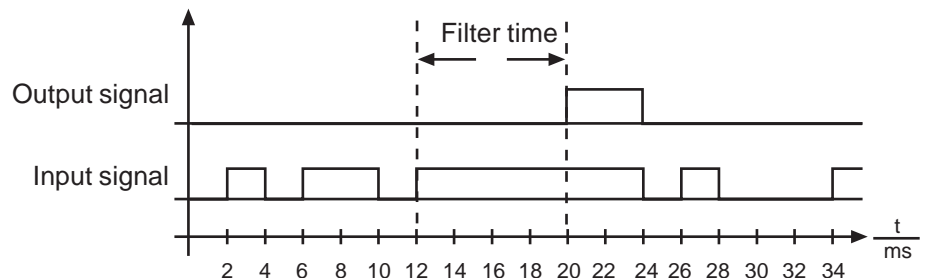

6.3.14 Inverting of Switching Conditions do.17...do.24

Fig. 6.3.14 Inverting and selecting of switching conditions

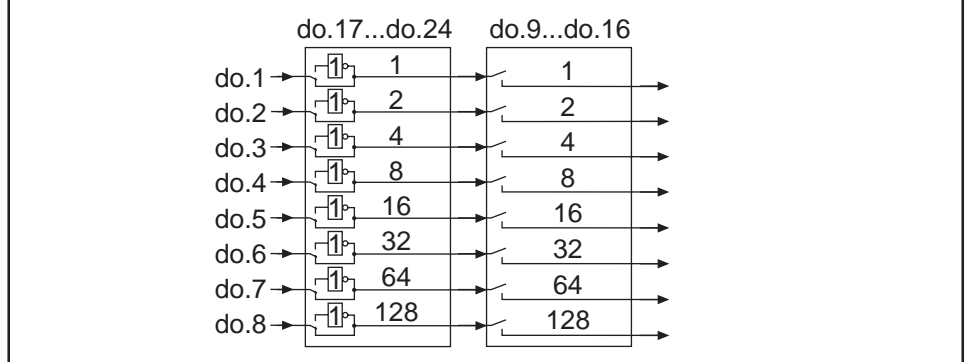

By means of parameter do.17...do.24 each of the eight switching conditions (do1...do.8) can be inverted separately for each output. The parameter is bit-coded. According to Fig. 6.3.14 the weighting for the switching condition to be inverted is to be entered in do.17...do.24. If several conditions shall be inverted add up the sum.

6.3.15 Selection of Switching Conditions (do.9...do.16)

The switching conditions are assigned to the outputs in parameters do.9...do.16. The selection is done separately for each output. At that you can choose between none or up to all eight switching conditions. According to Fig. 6.3.14 the weighting of the selected switching conditions is to be entered in do.9...do.16. If several conditions shall be selected add up the sum.

6.3.16 Logic Operation of Switching Conditions (do.25)

After the switching conditions are defined for each output, you can now select how they are operated. As a standard all conditions are OR-operated, i.e. if one of the selected conditions is fulfilled the output is set. As another possibility an AND-operation is available which is adjusted with do.25. AND-operation means that all selected conditions must be met before the output is set. Parameter do.25 is bit-coded. The table of 6.3.16 shows the assignment.

Fig. 6.3.16 Logic operation of switching conditions and inverting of outputs

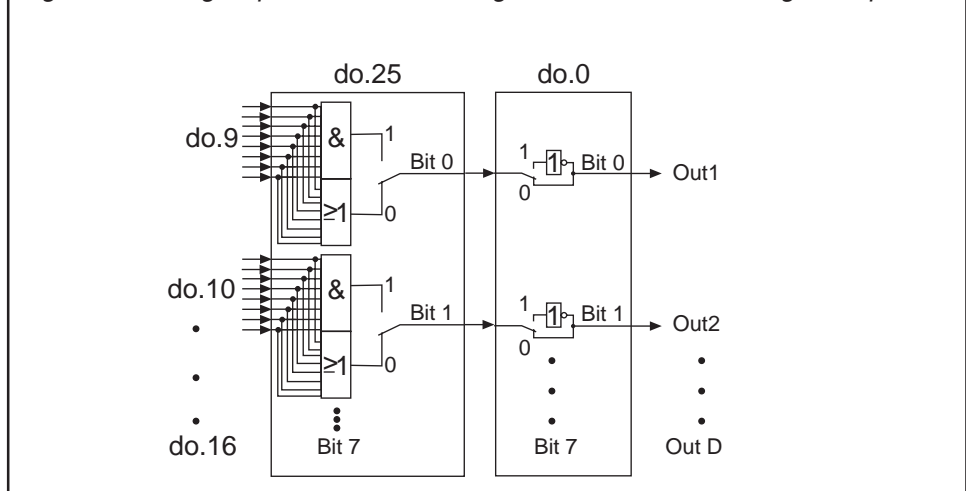

6.3.17 Inverting of Outputs (do.0)

As shown in Fig. 6.3.16 with parameter do.0 the outputs can be inverted. The parameter is bit-coded, i.e. according to following table the value belonging to the output must be entered. If several outputs shall be inverted add up the sum.







Terminal	Name	Function	Decimal value do.0, do.25 u. ru.15
X2.8	Out1	transistor output 1	1
X2.9	Out2	transistor output 2	2
X2.20...22	Out3	relay output	4
-	-	reserved	-
-	Out A	internal output	16
-	Out B	internal output	32
-	Out C	internal output	64
-	Out D	internal output	128

Example: Out1 and Out3 to be inverted ⇨ $1+4 = 5$



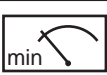

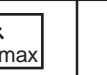



6.3.18 Output Terminal Status (ru.15)

The output terminal status indicates the logic condition of the digital outputs. At that it is irrelevant whether the output is set based on the conditions or through inverting. If an output is set the corresponding decimal value according to the above table is displayed. If several outputs are set then the sum of the decimal value is indicated.

6.3.19 Used Parameters

Param.	Adr.								
di.0	2900h	✓	-	-	0,0ms	20,0ms	0,1ms	0,5ms	-
di.1	2901h	✓	-	✓	0:PNP	1:NPN	1	PNP	-
di.2	2902h	✓	-	✓	0	127	1	0	bit-coded
di.3	2903h	✓	-	✓	0	22	1	4	-
di.4	2904h	✓	-	✓	0	22	1	5	-
di.5	2905h	✓	-	✓	0	22	1	3	-
di.6	2906h	✓	-	✓	0	22	1	15	-
di.7	2907h	✓	-	✓	0	22	1	0	-
di.8	2908h	✓	-	✓	0	22	1	0	-
di.9	2909h	✓	-	✓	0	22	1	0	-
di.10	290Ah	✓	-	✓	0	22	1	0	-
di.11	290Bh	✓	-	✓	0	22	1	16	-
di.12	290Ch	✓	-	✓	0	22	1	17	-
di.15	290Fh	✓	-	✓	0	127	1	0	bit-coded
di.16	2910h	✓	-	✓	0	127	1	0	bit-coded
di.17	2911h	✓	-	✓	0	4095	1	0	bit-coded
di.18	2912h	✓	-	✓	0	4095	1	0	bit-coded
di.19	2913h	✓	-	✓	0	1	1	0	-
do.0	2A00h	✓	✓	✓	0	255	1	0	bit-coded
do.1	2A01h	✓	✓	✓	0	35	1	20	-
do.2	2A02h	✓	✓	✓	0	35	1	18	-
do.3	2A03h	✓	✓	✓	0	35	1	2	-
do.4	2A04h	✓	✓	✓	0	35	1	0	-
do.5	2A05h	✓	✓	✓	0	35	1	0	-
do.6	2A06h	✓	✓	✓	0	35	1	0	-
do.7	2A07h	✓	✓	✓	0	35	1	0	-
do.8	2A08h	✓	✓	✓	0	35	1	0	-
do.9	2A09h	✓	✓	✓	0	255	1	1	bit-coded
do.10	2A0Ah	✓	✓	✓	0	255	1	2	bit-coded
do.11	2A0Bh	✓	✓	✓	0	255	1	4	bit-coded
do.13	2A0Dh	✓	✓	✓	0	255	1	0	bit-coded
do.14	2A0Eh	✓	✓	✓	0	255	1	0	bit-coded
do.15	2A0Fh	✓	✓	✓	0	255	1	0	bit-coded

Param.	Adr.	R/W	PROG.	ENTER	min	max	Step	default	
do.16	2A10h	✓	✓	✓	0	255	1	0	bit-coded
do.17	2A11h	✓	✓	✓	0	255	1	0	bit-coded
do.18	2A12h	✓	✓	✓	0	255	1	0	bit-coded
do.19	2A13h	✓	✓	✓	0	255	1	0	bit-coded
do.21	2A15h	✓	✓	✓	0	255	1	0	bit-coded
do.22	2A16h	✓	✓	✓	0	255	1	0	bit-coded
do.23	2A17h	✓	✓	✓	0	255	1	0	bit-coded
do.24	2A18h	✓	✓	✓	0	255	1	0	bit-coded
do.25	2A19h	✓	✓	✓	0	255	1	0	bit-coded
do.26	2A1Ah	✓	✓	✓	0	2	1	0	bit-coded
do.27	2A1Bh	✓	✓	✓	0	2	1	0	bit-coded
do.28	2A1Ch	✓	✓	✓	0	488	1	0	value x 2,048ms
do.29	2A1Dh	✓	✓	✓	0	488	1	0	value x 2,048ms
do.30	2A1Eh	✓	✓	✓	0	8	1	0	
do.31	2A1Fh	✓	✓	✓	0	8	1	0	
LE.4	2B04h	✓	✓	-	0,0 rpm	14.000 rpm	0,5 rpm	0,0 rpm	-
LE.5	2B05h	✓	✓	-	0,0 rpm	14.000 rpm	0,5 rpm	0,0 rpm	-
LE.6	2B06h	✓	✓	-	0,0 rpm	14.000 rpm	0,5 rpm	0,0 rpm	-
LE.7	2B07h	✓	✓	-	0,0 rpm	14.000 rpm	0,5 rpm	0,0 rpm	-
LE.8	2B08h	✓	✓	-	0 %	200 %	1 %	0 %	-
LE.9	2B09h	✓	✓	-	0 %	200 %	1 %	0 %	-
LE.10	2B0Ah	✓	✓	-	0 %	200 %	1 %	0 %	-
LE.11	2B0Bh	✓	✓	-	0 %	200 %	1 %	0 %	-
LE.12	2B0Ch	✓	✓	-	0,0 A	500,0 A	0,1 A	0,0 A	-
LE.13	2B0Dh	✓	✓	-	0,0 A	500,0 A	0,1 A	0,0 A	-
LE.14	2B0Eh	✓	✓	-	0,0 A	500,0 A	0,1 A	0,0 A	-
LE.15	2B0Fh	✓	✓	-	0,0 A	500,0 A	0,1 A	0,0 A	-
LE.20	2B18h	✓	✓	-	0,0 Nm	2000,0 Nm	0,1 Nm	0 Nm	-
LE.21	2B19h	✓	✓	-	0,0 Nm	2000,0 Nm	0,1 Nm	0 Nm	-
LE.22	2B1Ah	✓	✓	-	0,0 Nm	2000,0 Nm	0,1 Nm	0 Nm	-
LE.23	2B1Bh	✓	✓	-	0,0 Nm	2000,0 Nm	0,1 Nm	0 Nm	-
LE.28	2B1Ch	✓	✓	-	0,0°	2800,0°	0,1°	0,0°	-
LE.29	2B1Dh	✓	✓	-	0,0°	2800,0°	0,1°	0,0°	-
LE.30	2B1Eh	✓	✓	-	0,0°	2800,0°	0,1°	0,0°	-
LE.31	2B1Fh	✓	✓	-	0,0°	2800,0°	0,1°	0,0°	-

Param.	Adr.	 R/W	 PROG.	 ENTER	 min	 max	 Step	 default	
LE.37	2B25h	✓	-	-	0,0 rpm	14.000 rpm	0,5 rpm	10,0 rpm	-
LE.38	2B26h	✓	-	-	0 A	50,0 A	0,1 A	0,2	-
LE.39	2B27h	✓	-	-	0,0°	2800,0°	0,1°	1,0°	-
LE.40	2B28h	✓	-	-	0,0°	1000,0°	0,1°	0,2°	-
LE.48	2B30h	✓	✓	-	0 inc	28000 inc	1 inc	0 inc	-
LE.50	2B32h	✓	✓	-	0	2	1	0	-
LE.51	2B33h	✓	✓	-	0 inc	65535 inc	1 inc	0 inc	-
LE.52	2B34h	✓	✓	-	0 inc	65535 inc	1 inc	0 inc	-
LE.53	2B35h	✓	✓	-	0	2	1	0	-
LE.54	2B36h	✓	✓	-	0 inc	65535 inc	1 inc	0 inc	-
LE.55	2B37h	✓	✓	-	0 inc	65535 inc	1 inc	0 inc	-
LE.56	2B38h	✓	✓	-	0	2	1	0	-
LE.57	2B39h	✓	✓	-	0 inc	65535 inc	1 inc	0 inc	-
LE.58	2B3Ah	✓	✓	-	0 inc	65535 inc	1 inc	0 inc	-
LE.59	2B3Bh	✓	✓	-	0	2	1	0	-
LE.60	2B3Ch	✓	✓	-	0 inc	65535 inc	1 inc	0 inc	-
LE.61	2B3Dh	✓	✓	-	0 inc	65535 inc	1 inc	0 inc	-
LE.66	2B42h	✓	-	-	0	65535	1	0	ms
LE.67	2B43h	✓	-	-	0	5000	1	0	ms
LE.68	2B44h	✓	-	-	0	5000	1	0	ms
ru.14	200Eh	-	-	-	0	127	1	-	-
ru.15	200Fh	-	-	-	0	247	1	-	-
ru.16	2010h	-	-	-	0	3967	1	-	-
ru.17	2011h	-	-	-	0	255	1	-	-

- 1. Introduction
- 2. Summary
- 3. Hardware
- 4. Operation
- 5. Parameter
- 6. Functions**
- 7. Start-up
- 8. Special Operation
- 9. Error Assistance
- 10. Project Planning
- 11. Networks
- 12. Applications
- 13. Annex

- 6.1 Operating and Unit Data
- 6.2 Analog In- and Outputs
- 6.3 Digital In- and Outputs
- 6.4 Set Value and Ramp Adjustment**
- 6.5 Motor Data and Controller Adjustment
- 6.6 Keep on Running Functions
- 6.7 Parameter Sets
- 6.8 Special Functions
- 6.9 Encoder Interface
- 6.10 Synchronous Control
- 6.11 Positioning Module
- 6.12 CP-Parameter Definition

- 6.4.1 Brief Description 3
- 6.4.2 AUX-Function, Setpoint and Rotation Selection 4
- 6.4.3 Setpoint Limits 7
- 6.4.4 Setpoint Calculation 8
- 6.4.5 Ramp Generator 10
- 6.4.6 Used Parameters 13

Chapter 6	Section 4	Page 2	Date 23.10.02	Name: Basis KEB COMBIVERT F4-F	© KEB Antriebstechnik, 2002 All Rights reserved
---------------------	---------------------	------------------	------------------	--	--

6.4 Set Value and Ramp Adjustment

6.4.1 Brief Description

The setpoint values of the KEB COMBIVERT F4-F can be adjusted analog (REF1 (REF2) as well as digital. The AUX-function offers the possibility to add an analog setpoint to other setpoint settings or to use it as amplification factor for speed controller and torque limits.

The setpoint and rotation selection links the different setpoint sources with the possible rotation sources. The signal which is received in this manner (except for setpoint setting directly) is used for the further setpoint calculation.

Only after scanning for the absolute setpoint limits all data which is necessary for the ramp calculation is available.

Fig. 6.4.1 Diagram of setpoint and ramp adjustment

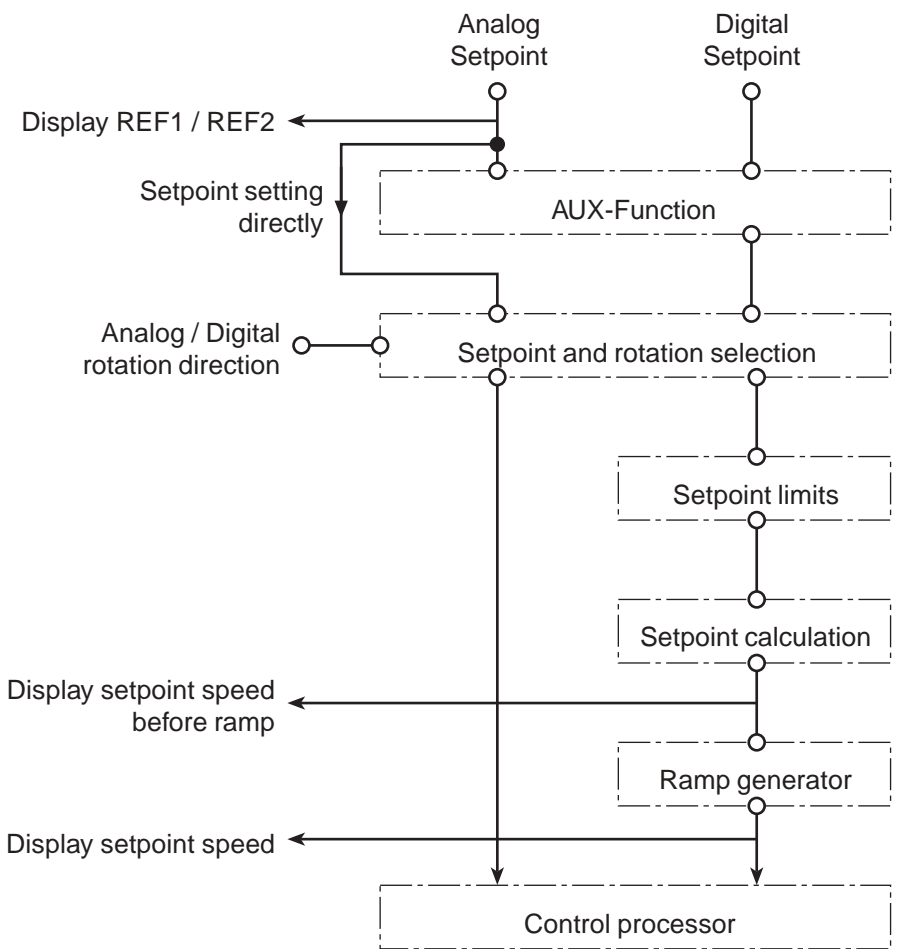

6.4.2 AUX-Function, Setpoint and Rotation Selection

Fig. 6.4.2 Setpoint values and AUX-function

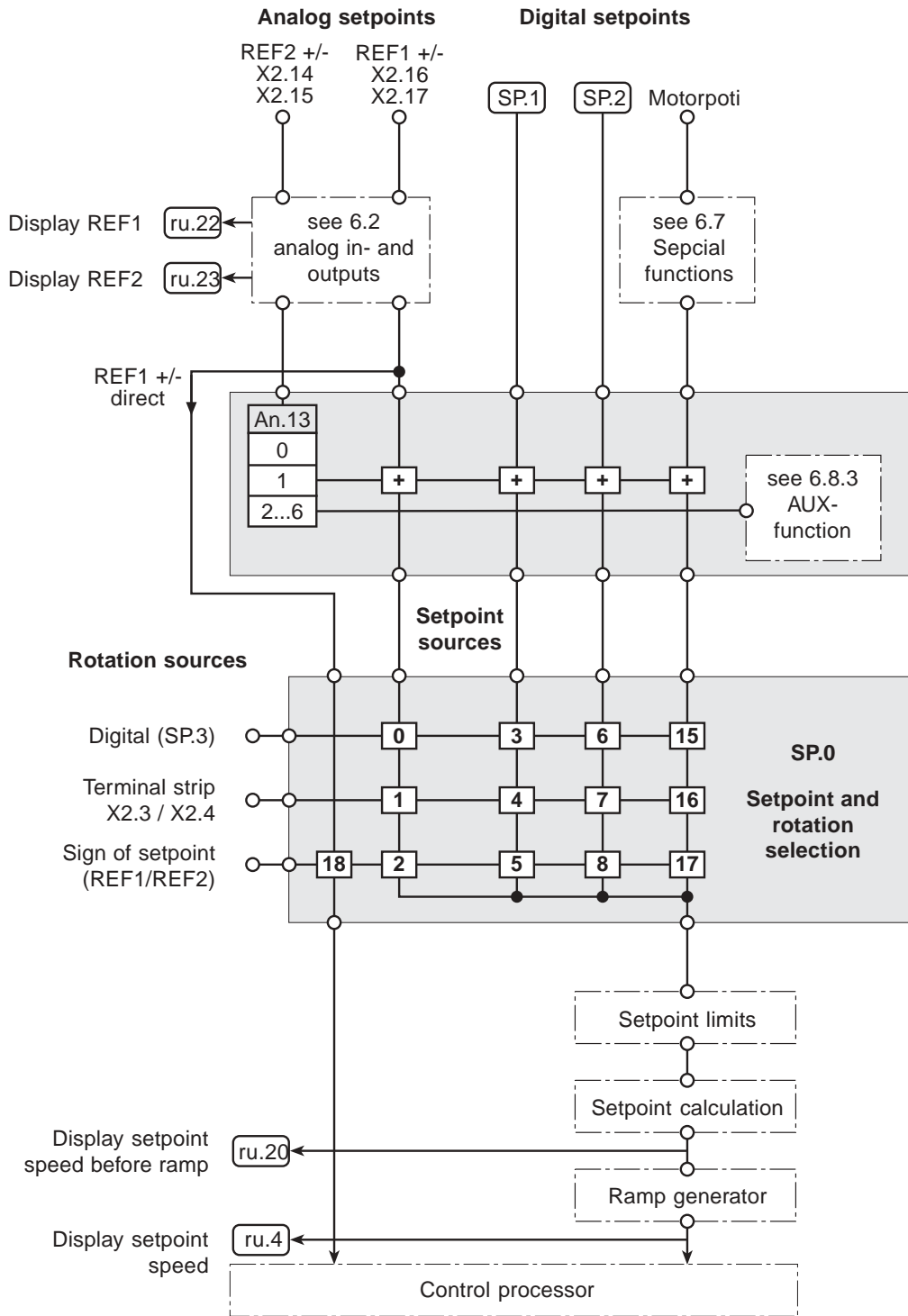

Setpoint values To adjust a speed setpoint the KEB COMBIVERT F4-F provides two analog setpoint values (REF1 +/- and REF2 +/-) and three digital setpoint values (parameter SP.1, parameter SP.2 and the motor potentiometer function).

Analog setpoints: The analog setpoint values are adjusted by way of REF1 +/- or REF2 +/- . Internally the setpoint signals on REF1 change to REF-internal and on REF2 to AUX-internal. The setpoint values are indicated in the parameters ru.22 and ru.23.

Concerning adjustments and analog setpoint settings refer to Chapter 6.2 „Analog In- and Outputs“.

- Digital setpoints: (SP.1, SP.2)
1. With parameter SP.1 „*Absolut digital setpoint setting*“ a setpoint speed of -9999,5 rpm ... +9999,5 rpm can be adjusted.
 2. With parameter SP.2 „*Percentual digital setpoint setting*“ a setpoint speed of -100% ... +100% of the maximum speed (SP.5 / SP.7) can be adjusted (**also see 6.4.3 „Setpoint calculation“**)
 3. With the motor potentiometer function a setpoint speed between the values adjusted in parameter SP.4 / SP.5 and SP.6 / SP.7 (**see 6.7 „Special functions“**) can be adjusted in rpm by way of digital inputs.

Direct analog setpoint input (SP. 0 = 18) Only available in the standard-/synchronous module (Pc.0 = 0), is handled in the positioning module like SP.0 = 2 (standard analog setpoint input):

The cycle time of the software is 2,048 ms. During this time the analog input/output status is updated once. Before the new setpoint is calculated, the inverter additionally needs a processing time of 1...3 ms. When the inverter is used as an underlayered control element of a master control, this time can have an influence on the dynamic of the closed-loop control.

For these cases the analog setvalue can be given directly to the control processor (direct setvalue input). A scan time of 128 µs is possible by this. Some restrictions must be taken into consideration to realize this fast reaction of an analog setvalue:

- The speed limits SP. 4...SP. 7 do not have a function; the speed setvalue is only limited with SP. 8 and SP. 9.
- The calculation formula of the analog setvalue changes. Parameter SP. 4...SP. 7 do not have an influence to the setvalue calculation. The reference point of the setvalue calculation is 3000 rpm.
 $nset = (analog\ value / 10V * 100\% - An. 4) * An. 3 * 3000\ rpm$
- Acceleration/deceleration and S-curve times do not have an influence (SP.11 to SP.18); internal processing without ramps.
- Zero clamp speed (An. 2) and REF1 Offset Y (An. 5) do not have a function
- The Aux-input can not be assigned with the function 1 (AUX works added to the setvalue).
- The max. filter time for the analog inputs is 2 ms (An.1 = 4).
- The position standstill controller can not be activated.

AUX function (An.13) The AUX-function offers the possibility to add an analog setpoint to the other setpoint settings within the preadjusted maximum values (**see 6.4.3 „Setpoint calculation“**) or to use it as amplification factor for speed controllers as well as for torque limits. Parameter An.13 defines the function of the AUX-internal signal.

An.13	AUX-internal
0	no function
1	is added to the selected setpoint signal (analog or digital) setpoint = setpoint signal + AUX-internal signal (-10 V ... +10 V)
2...9	see chapter 6.8.3 AUX-function

Setpoint and rotation selection

With parameter SP.0 „Setpoint and rotation selection“ the required setpoint source and the corresponding rotation source can be linked (see Fig. 6.4.2).

Setpoint source: The setpoint can be preset with the following sources:

- analog (REF1)
- digital absolute (SP.1)
- digital in per cent (SP.2)
- motorpoti (see chapter 6.8.4)
- analog direct (fast setpoint setting)

Rotation source: Concerning the rotation sources it must be differentiated between three possible preadjustments:

1. Direction of rotation by way of parameter SP.3 „Digital rotation setting“

Digital rotation setting (SP.3)

Set values:

SP.3	Display	Setpoint rotation
0	LS (Low Speed)	standstill
1	F (Forward)	forward
2	r (Reverse)	reverse

2. Direction of rotation by way of terminal strip X2

The direction of rotation can be adjusted by way of assigning terminal forward or reverse. If both terminals are assigned at the same time then direction of rotation forward has priority.

Connection / Activation of direction of rotation see Chapter 6.3 „Digital In- and Outputs“.

3. Direction of rotation through sign of setpoint

For analog signals by adjusting positive or negative voltages and for digital signals by adjusting positive or negative values.

- positive value -> rotation forward
- negative value -> rotation reverse

Setpoint and rotation selection (SP.0)

SP.0	Setpoint	Direction of rotation
0	analog (REF1)	digital (SP.3)
1	analog (REF1)	terminal strip
2	analog (REF1)	sign of setpoint
3	digital absolute (SP.1)	digital (SP.3)
4	digital absolute (SP.1)	terminal strip
5	digital absolute (SP.1)	sign of setpoint
6	digital percentual (SP.2)	digital (SP.3)
7	digital percentual (SP.2)	terminal strip
8	digital percentual (SP.2)	sign of setpoint
9...14	reserved, not used	
15	motorpotentiometer	digital (SP.3)
16	motorpotentiometer	terminal strip
17	motorpotentiometer	sign of setpoint
18	analog direct (REF1 +/- direct)	sign of setpoint

6.4.3 Setpoint Limits

Following limit values can be adjusted:

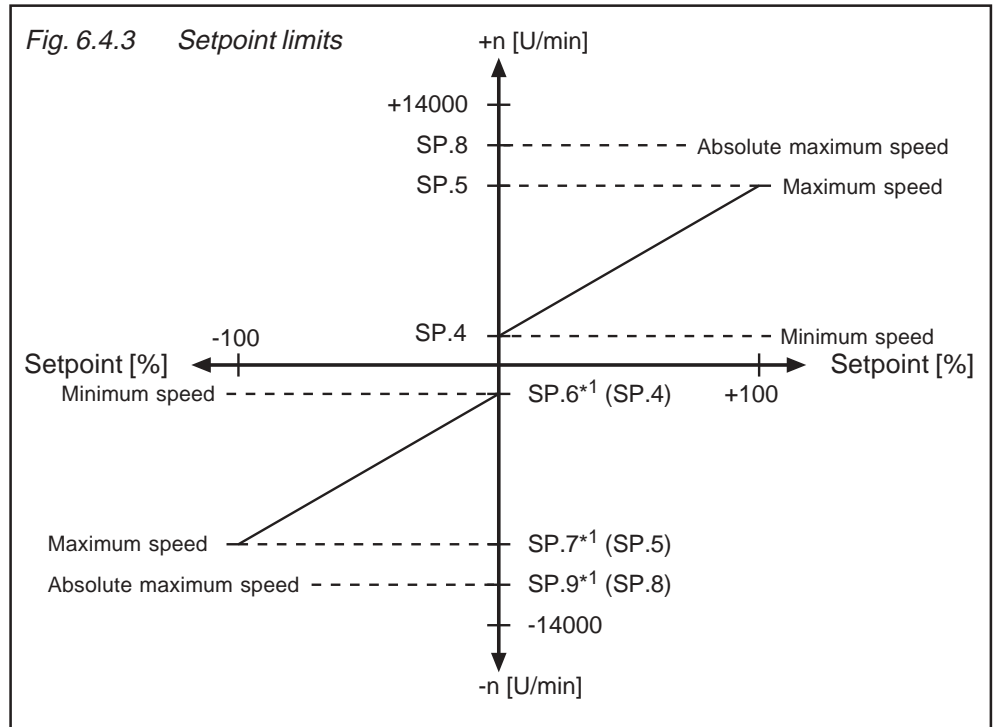

*1 If the value „off“ is adjusted in these parameters (limit values direction of rotation reverse), then the values adjusted for direction of rotation forward (SP.4, SP.5 und SP.8) apply for it.

Minimum / maximum speed (SP.4...SP.7)

In order to restrict the setpoint speed minimum and maximum speed must be adjusted. These limit values form the basis for the further setpoint calculation and for the determination of the speed characteristics, **also see Chapter 6.4.4 „Setpoint calculation“**.

The frequency inverter F4-F offers the possibility to adjust separate limits for both directions of rotation.

The maximum speed limits the setpoint speed only. Because of speed ripples, speed overshoot or hardware defects (e.g. defective encoder) the actual speed may exceed these limits.

Speed difference acceleration/ deceleration (SP.10)

The ramp times refer to the speed value adjusted in SP.10.

6.4.4 Setpoint Calculation

<p>Analog setpoint setting</p>	<p>Setpoint setting : -10V ... +10V (REF1)</p> <p>At SP.0 = 0 and 1 negative setpoint values are internally set to 0 and the direction of rotation is adjusted digital by way of parameter SP.3 or terminals forward and reverse. At SP.0 = 2 the direction of rotation is defined through the sign of the setpoint.</p>	<p>Fig. 6.4.4 Setpoint analog</p>
<p>Absolute digital setpoint setting</p>	<p>Setpoint setting : -9999,5 rpm ... +9999,5 rpm (parameter SP.1)</p> <p>At SP.0 = 3 and 4 negative setpoint values are internally set to 0 and the direction of rotation is adjusted digital by way of parameter SP.3 or terminals forward and reverse. At SP.0 = 5 the direction of rotation is defined through the sign of the setpoint.</p> <p>Attention! Speed values up to +/- 9999,5 rpm can be adjusted, however, internally the calculation is done only with the adjusted maximum speed values.</p>	<p>Fig. 6.4.5 Setpoint digital absolute</p>
<p>percentual digital setpoint setting</p>	<p>Setpoint setting : -100%...+100% (parameter SP.2)</p> <p>At SP.0 = 6 and 7 negative setpoint values are internally set to 0 and the direction of rotation is adjusted digital by way of parameter SP.3 or terminals forward and reverse. At SP.0 = 8 the direction of rotation is defined through the sign of the setpoint.</p>	<p>Fig. 6.4.6 Setpoint digital percentual</p>

Motor potentiometer-setpoint setting	<p>Setpoint setting : through activation of digital inputs</p> <p>At SP.0 = 15 and 16 negative setpoint values are internally set to 0 and the direction of rotation is adjusted digital by way of parameter SP.3 or terminal forward and reverse.</p> <p>At SP.0 = 17 the direction of rotation is defined through the sign of the setpoint.</p> <p>Adjustments and method of operation of the motor potentiometer function are described in Chapter 6.8 „Special functions“.</p>	<p>Fig. 6.4.7 Setpoint motor potentiometer</p>
Direct analog setpoint setting	<p>Setpoint setting : -10V ... +10V (REF1)</p> <p>At SP.0 = 18 the direction of rotation is defined only by the sign of the setpoint.</p> <p>The setpoint is limited only by the absolute maximum speeds (SP.8 / SP.9).</p> <p>Functions and restrictions concerning the direct setpoint setting are described in chapter 6.4.2.</p>	<p>Fig. 6.4.8 Setpoint analog direct</p>

Setpoint addition (AUX function An.13) With the adjusted setpoint limits (SP.4...SP.7) the speed range 0% ($\hat{=}$ minimum speed) up to 100% ($\hat{=}$ maximum speed) is also defined for the AUX-internal setpoint signal.

1. If the digital rotation setting (parameter SP.3 or terminal strip) is selected with parameter SP.0 the adjusted setpoint signals are added up sign-correct. The result forms the valid setpoint speed. Negative values in the result are set to zero.

Example: Setpoint signal at REF1: + 3 V
 Setpoint signal at AUX (REF2): - 2 V
 Valid setpoint speed: + 1 V corresponds to 10% of the speed range with preset digital direction of rotation

2. If with parameter SP.0 the rotation setting is selected through the sign of the setpoint, then the adjusted setpoint signals are added up sign-correct. The sign of the result defines the direction of rotation and the sum of the result represents the valid setpoint speed.

Example: Setpoint signal at REF-internal: + 3 V
 Setpoint signal at AUX-internal: - 5 V
 Valid setpoint speed: - 2 V corresponds to 20% of the speed range with direction of rotation reverse

3. Parameter SP.0 = 18 (direct analog setpoint setting), with this setting the AUX-function has no effect. The setpoint is defined only by the setpoint signal at REF1.

6.4.5 Ramp Generator

The frequency inverter KEB COMBIVERT F4-F offers the possibility to display the adjusted setpoint speed before and after the ramp generator. The setpoint speed before the ramp generator is indicated in parameter ru.20 and the setpoint speed after the ramp generator is shown in parameter ru.4.

Acceleration and deceleration times

For the adjustment of the ramps the acceleration and deceleration times of the drive must be preset. With parameters SP.11...SP.14 the time is defined which is required to accelerate from 0 U/min to 1000 U/min respectively to decelerate from 1000 U/min to 0 U/min. The actual acceleration time behaves proportional to the speed change (Δn).

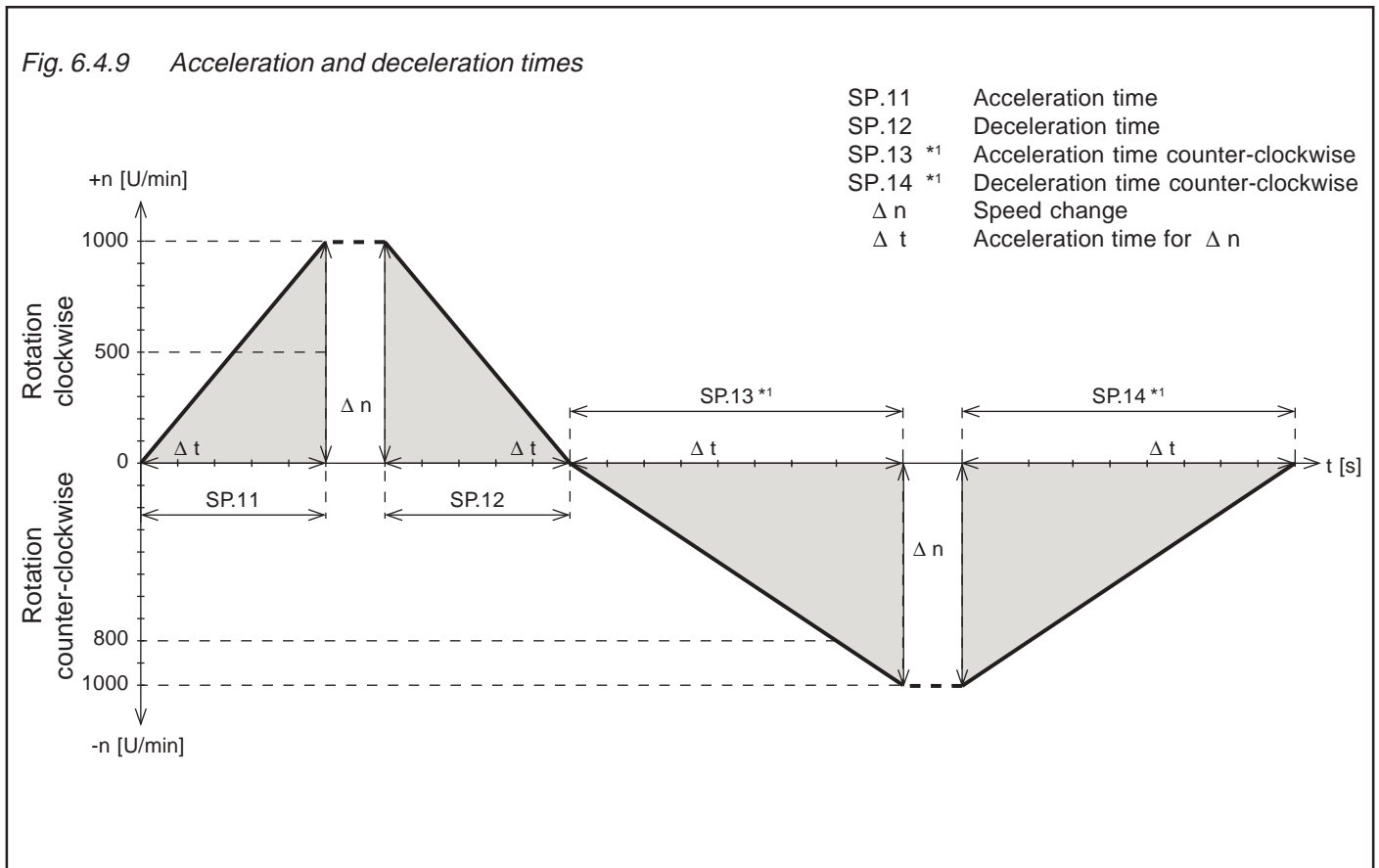

*1 If the value „off“ is adjusted in these parameters (acceleration and deceleration times for rotation counter-clockwise) then the values adjusted in the parameters for clockwise rotation (SP.11 and SP.12) are valid.

Calculation of acceleration and deceleration times:
(also refer to following calculation examples)

$$SP.11....SP.14 = \frac{\Delta t}{\Delta n} \times SP.10$$

Example 1: The drive shall meet following acceleration and deceleration values:

Rotation clockwise: acceleration from 0 U/min to 500 U/min in **2,5 s** (SP.11)
deceleration from 500 U/min to 0 U/min in **2,5 s** (SP.12)

Rotation counter-clockwise: acceleration from 0 U/min to 800 U/min in **7,2 s** (SP.13)
deceleration from 800 U/min to 0 U/min in **7,2 s** (SP.14)

For that the calculated values listed below must be entered in the parameters SP.11...SP.14

for **SP.10** = 1000 U/min

$$\text{SP.11} = \frac{\Delta t}{\Delta n} \times \text{SP.10} \quad \text{with } \Delta n = (500 \text{ U/min} - 0 \text{ U/min}) = 500 \text{ U/min} \quad \text{and } \Delta t = 2,5 \text{ s}$$

$$\text{SP.11} = \frac{2,5 \text{ s}}{500 \text{ U/min}} \times 1000 \text{ U/min} = \mathbf{5 \text{ s}}$$

$$\text{SP.12} = \frac{2,5 \text{ s}}{500 \text{ U/min}} \times 1000 \text{ U/min} = \mathbf{5 \text{ s}}$$

$$\text{SP.13} = \frac{7,2 \text{ s}}{800 \text{ U/min}} \times 1000 \text{ U/min} = \mathbf{9 \text{ s}}$$

$$\text{SP.14} = \frac{7,2 \text{ s}}{800 \text{ U/min}} \times 1000 \text{ U/min} = \mathbf{9 \text{ s}}$$

Example 2: The drive shall meet the following acceleration and deceleration values:

Rotation clockwise: acceleration from 0 U/min to 500 U/min in **2,5 s** (SP.11)
deceleration from 500 U/min to 0 U/min in **5,0 s** (SP.12)

Rotation counter-clockwise: acceleration from 0 U/min to 500 U/min in **2,5 s** (SP.13)
deceleration from 500 U/min to 0 U/min in **5,0 s** (SP.14)

For that the calculated values listed below must be entered in the parameters SP.11...SP.14:

for **SP.10** = 1000 U/min

$$\text{SP.11} = \frac{2,5 \text{ s}}{500 \text{ U/min}} \times 1000 \text{ U/min} = \mathbf{5 \text{ s}}$$

$$\text{SP.12} = \frac{5,0 \text{ s}}{500 \text{ U/min}} \times 1000 \text{ U/min} = \mathbf{10 \text{ s}}$$

$$\text{SP.13} = \frac{2,5 \text{ s}}{500 \text{ U/min}} \times 1000 \text{ U/min} = \mathbf{5 \text{ s}} \quad (\text{or enter off, as SP.11} = \text{SP.13})$$

$$\text{SP.14} = \frac{5,0 \text{ s}}{500 \text{ U/min}} \times 1000 \text{ U/min} = \mathbf{10 \text{ s}} \quad (\text{or enter off, as SP.12} = \text{SP.14})$$



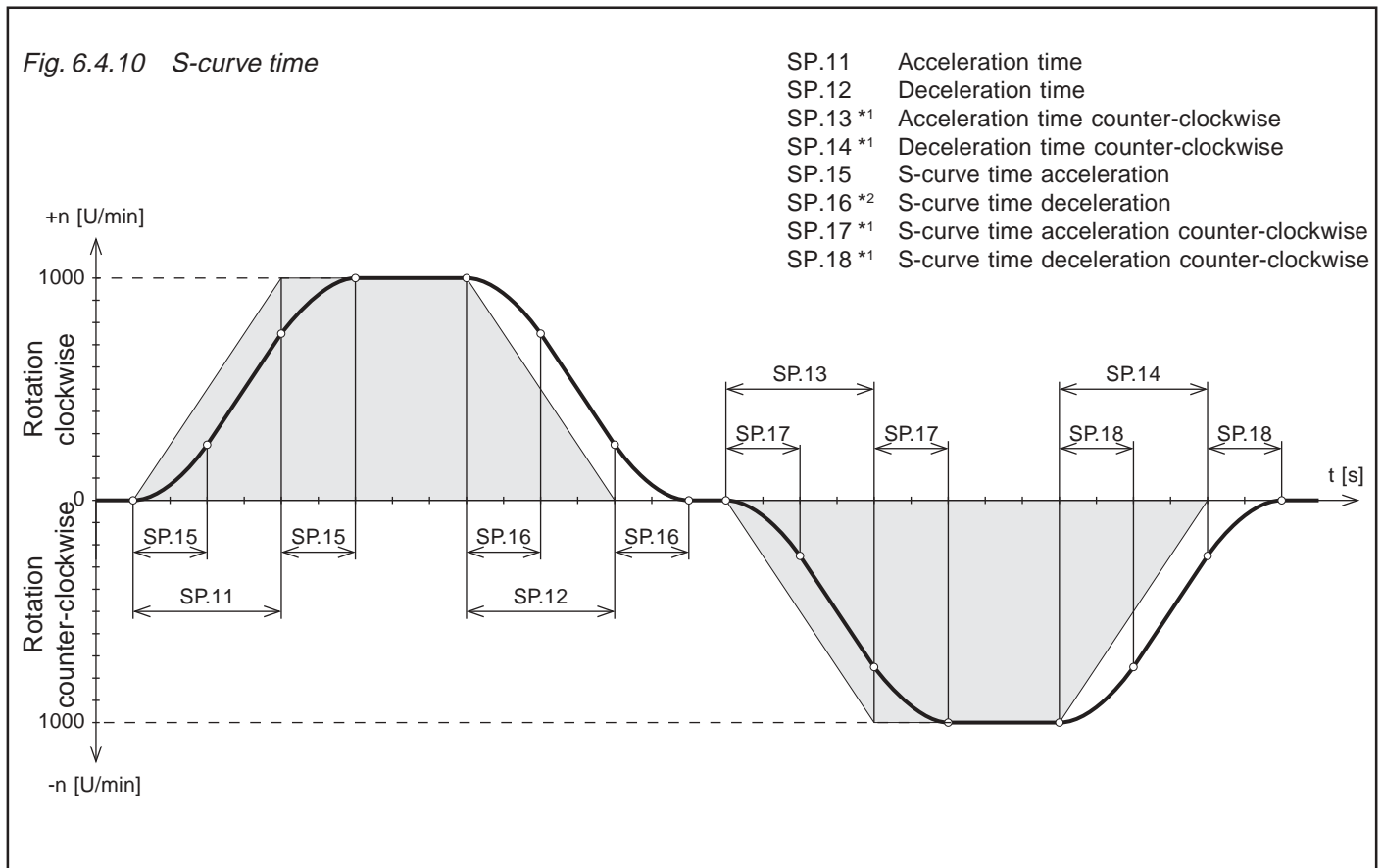

S-curve time For some applications it is an advantage when the drive starts and stops jerk-free. This function is achieved through a balancing of the acceleration and deceleration ramps. The balancing time, S-curve time, is adjusted with the parameters SP.15...SP.18.

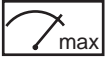

*1 If the value „off“ is adjusted in these parameters (for rotation counter-clockwise), then the values adjusted in the parameters for rotation clockwise are valid.

*2 If in addition to parameters SP.17 and SP.18 (S-curve time for rotation counter-clockwise) the value „off“ is also adjusted in parameter SP.16, then the time adjusted in parameter SP.15 is valid for all S-curve times.

6.4.6 Used Parameters

Param.	Adr.	R/W	PROG.	ENTER					
ru.4	2004h	-	-	-	-	-	0,5 rpm	-	-
ru.20	2014h	-	-	-	-	-	0,5 rpm	-	-
ru.22	2016h	-	-	-	-100,0	100,0	0,1 %	-	-
ru.23	2017h	-	-	-	-100,0	100,0	0,1 %	-	-
SP.0	3000h	✓	✓	✓	0	18	1	2	-
SP.1	3001h	✓	✓	-	-14000 rpm	14000 rpm	0,5 rpm	0 rpm	-
SP.2	3002h	✓	✓	-	-100,0 %	100,0 %	0,1 %	0,0 %	-
SP.3	3003h	✓	✓	✓	0	2	1	0	-
SP.4	3004h	✓	✓	-	0,0 rpm	14000 rpm	0,5 rpm	0,0 rpm	-
SP.5	3005h	✓	✓	-	0,0 rpm	14000 rpm	0,5 rpm	2100,0 rpm	-
SP.6	3006h	✓	✓	-	0,0 rpm	14000 rpm	0,5 rpm	-1 : off	-
SP.7	3007h	✓	✓	-	0,0 rpm	14000 rpm	0,5 rpm	-1 : off	-
SP.8	3008h	✓	-	-	0,0 rpm	14000 rpm	0,5 rpm	6000,0 rpm	-
SP.9	3009h	✓	-	-	0,0 rpm	14000 rpm	0,5 rpm	-1 : off	-
SP.10	300Ah	-	✓	-	0,0 rpm	14000 rpm	0,5 rpm	1000 rpm	-
SP.11	300Bh	✓	✓	-	0,00 s	320,00 s	0,01 s	2,00 s	-
SP.12	300Ch	✓	✓	-	0,00 s	320,00 s	0,01 s	2,00 s	-
SP.13	300Dh	✓	✓	-	0,00 s	320,00 s	0,01 s	-1 : off	-
SP.14	300Eh	✓	✓	-	0,00 s	320,00 s	0,01 s	-1 : off	-
SP.15	300Fh	✓	✓	-	0,00 s	5,00 s	0,01 s	0,00 s	-
SP.16	3010h	✓	✓	-	0,00 s	5,00 s	0,01 s	-1 : off	-
SP.17	3011h	✓	✓	-	0,00 s	5,00 s	0,01 s	-1 : off	-
SP.18	3012h	✓	✓	-	0,00 s	5,00 s	0,01 s	-1 : off	-
SP.22	3016h	✓	-	-	0,0 rpm	14000 rpm	0,5 rpm	100	-
SP.26	301Ah	✓	-	-	0	15	1	0	-

Chapter 6	Section 4	Page 14	Date 23.10.02	Name: Basis KEB COMBIVERT F4-F	© KEB Antriebstechnik, 2002 All Rights reserved
---------------------	---------------------	-------------------	------------------	--	--

- 1. Introduction
- 2. Summary
- 3. Hardware
- 4. Operation
- 5. Parameter
- 6. Functions**
- 7. Start-up
- 8. Special Operation
- 9. Error Assistance
- 10. Project Planning
- 11. Networks
- 12. Applications
- 13. Annex

- 6.1 Operating and Unit Data
- 6.2 Analog In- and Outputs
- 6.3 Digital In- and Outputs
- 6.4 Set Value and Ramp Adjustment
- 6.5 Motor Data and Controller Adjustment**
- 6.6 Keep on Running Functions
- 6.7 Parameter Sets
- 6.8 Special Functions
- 6.9 Encoder Interface
- 6.10 Synchronous Control
- 6.11 Positioning Module
- 6.12 CP-Parameter Definition

- 6.5.1 Motor Name Plate 3
- 6.5.2 Motor Data from Name Plate .. 3
- 6.5.3 Motor Adaption (Fr.10) 4
- 6.5.4 Controlled Operation 5
- 6.5.5 Modulation Rate (dS.12) and Overmodulation (dS.14) 8
- 6.5.6 Operating Frequency (dS.13) .. 8
- 6.5.7 Controller Structure 9
- 6.5.8 Current Control (Torque Control) 10
- 6.5.9 Speed Control 10
- 6.5.10 Torque Limitation 11
- 6.5.11 Flux Lowering Calculation 12
- 6.5.12 Flux Control 13
- 6.5.13 Max. Voltage Control 13
- 6.5.14 Motor Parameter Adaption 14
- 6.5.15 Torque Control 19
- 6.5.16 Inertia Torque (dr.56) 21
- 6.5.17 Used Parameters 21

Chapter 6	Section 5	Page 2	Date 18.12.02	Name: Basis KEB COMBIVERT F4-F	© KEB Antriebstechnik, 2002 All Rights reserved
---------------------	---------------------	------------------	------------------	--	--

6.5 Motor Data and Controller Adjustment

The adjustment of the correct motor data is important for a lot of inverter functions, since this data is used for calculations which are needed by the inverter. Wrong settings can cause control oscillations and uncontrollable behaviour of the drive.

6.5.1 Motor Name Plate

Fig. 6.5.1 Example of a motor name plate

KEB ANTRIEBSTECHNIK		KEB Antriebstechnik GmbH & Co. KG Schneeberg		Made in Germany	
DK 160 L 4 F I /TW150				CE	
96/1632804/ 001					
dr.0	3 -Mot	IP 55	IM B 3	W.Kl. F	40 °C 127 kg
dr.12	VDE 053 0				
dr.3	15,0 KW				
dr.4	50 Hz	230/400	V Δ/Y		
dr.4	cos φ	0,86	49,5/28,5 A		
dr.1	1455	1/min	IGR 05B	2500 Imp	
			5V D0/RS	6xTTL	
U _{FL}		230/400	V		
3 ~Mot	50	Hz	M _{Br}	Nm	I _{Sp max} mm

6.5.2 Motor Data from Name Plate (dr.0...dr.4, dr.12)

Following parameters can be taken directly from the name plate (see above) and entered:

- dr.0 Rated motor power 0,01...75kW
- dr.1 Rated motor speed 100...9999 U/min
- dr.2 Rated motor current 0,1...1,1 x I_{n.01} (delta / star connection)
- dr.3 Rated motor frequency 20...300 Hz
- dr.4 Rated motor output factor 0,05...1,00
- dr.12 Rated motor voltage 100...500 V (delta / star connection)

Parameter dr.2 and dr.12 must always be adjusted in accordance with the used connection (star or delta). This means for the above motor name plate that it is 230 V / 48,5A for delta connection and 400 V / 28,5 A for star connection.

6.5.3 Motor Adaption (Fr.10)

After entering the name plate specifications of a new motor parameter Fr.10 should be activated once (inverter must be in status nOP). This creates a default setting for a number of control parameters which is sufficient for many applications. This adjustment depends on inverter identification data (like e.g. rated inverter current) and motor identification data (like e.g. motor rating and rated motor current).

Parameters which are changed through the activation of Fr.10:

- dr.13 Speed for maximum torque
- dr.16 Maximum torque corner speed
- dr.19 Corner speed field weakening
- dr.20 Field weakening curve
- dr.21 Flux adaption factor
- dS.0 KP I active
- dS.1 KI I active
- dS.5 KP I magnetizing
- dS.6 KI I magnetizing
- CS.6/CS.7/CS.8/CS.9 torque limits
- Pn.60 torque for abnormal stop
- CS.19 KP flux
- CS.20 KI flux
- Cs.21 magn. current limit

On the basis of these settings a fine adjustment can be carried out, e.g. an increase of the torque limits or a change of the field weakening time.

Control of the optimized settings: Over the entire speed range the modulation factor should not exceed approx. 90 .. 95 % (depending on the expected system fluctuations and temperature changes). However, the output voltage at the rated point should not be too low (e.g. modulation factor at rated speed and rated load < 70 %), since such a setting would result in a motor current that is too high.

Procedure:

1. Open control release (status nOP)
2. Enter motor name plate data in the corresponding parameters (dr.0...12).
3. Adjust Fr.10 = 1 or Fr.10 = 2 ⇒ the corresponding dr/dS parameters are loaded with the default-parameters.
4. If necessary, carry out a fine adjustment on the basis of these settings.

Value	Meaning
1, 2	Pre-adjustment of the motor-dependent control-parameters for standard operation (without adaption / CS.10 = 0) The equivalent circuit data of dr.48...dr.52 are not needed.
3...6	These values are only needed at operations with adaption.

uneven values (1, 3, 5): the adjusted voltage value (dS.10 or, in case dS.10 is not activated, the voltage class of the inverter is used as reference value for the calculation of motor-dependent parameters.

even values (2, 4, 6): the DC-link voltage / $\sqrt{2}$ measured at the switch is used as reference value for the calculation of motor-dependent parameters.

This means: If the parameterizing of an inverter is done e.g. at a system input voltage of 400 V, while the drive operates later on a 460 V system, then either parameter Fr.10 = 2 must be written again or the inverter must already be parameterized on the 400V-system by means of dS.10 = 460V and Fr.10 = 1 for the 460 V system.

6.5.4 Control Method

With CS.23 all of the controller functions are activated/deactivated.

CS.23	Function
0	open loop operation (inverter performs according to U/f-characteristic)
1	closed loop operation

Restrictions The control method is suited only as emergency operation for set up or in case of a faulty encoder.

Increased oscillating torque compared to controlled operation.

ru.1 Continues to indicate the actual speed measured by encoder 1.

ru.2/ru.10 Active current and actual torque are internally set to zero, i.e. ru.2 and ru.10 always display the value 0. If outputs are programmed to torque-dependent switching or if a torque signal is given out over an analog output then the outputs behave like they do at actual torque/active current = 0.

ru.4 Indicates the actual output frequency converted into min^{-1}

$$\text{ru.4} = \frac{\text{Output frequency}}{\text{Pole pair number}} \times 60$$

dr.1/dr.3 Serve for the calculation of the pole pair number, for that reason they must be adjusted correctly even in controlled operation.

dr.3/dr.12/ds.11/ds.10 Define the voltage/frequency-characteristic.

dr.13/dr.16 If the speed control is deactivated then all torque limits are without effect.

CS-Parameter Are without function in controlled operation. speed and flow controller are not active.

dS-Parameter Only dS.10 (voltage stabilization) and dS.11 (Boost) are still effective.

Sn-Parameter The controlled operation can be activated in the synchronous module (Pc.0 = on) and the positioning module (Pd.0 = on). The positioning (Pd.0 = on) or synchronous control (Sn.0 = on) should be activated only at switched on speed control, otherwise the positioning control is very instable.

U/f-Characteristic The voltage/frequency characteristic (U/f) is defined through following parameters:

- Rated motor frequency (dr.3)
- Rated motor voltage (dr.12)
- Boost (dS.11)
- Corner speed field weakening (dr.19)
- Output voltage stabilization (dS.10) or max. output voltage

Fig. 6.5.5 U/f-characteristic

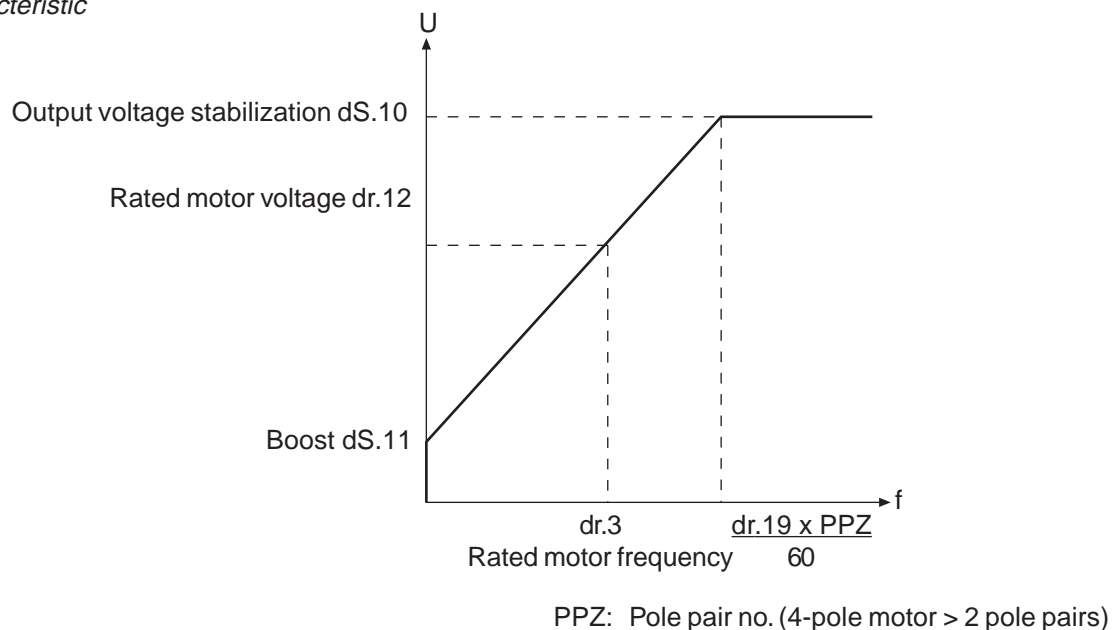

Boost (dS.11) In controlled operation the boost defines the output speed at 0 Hz. The adjustment is done in percent related to the value of the output voltage stabilization set in dS.10. The boost is effective in controlled operation only.

Output Voltage Stabilization (dS.10) Fluctuations of the system voltage or of the load can cause the DC-link voltage to change and with it the directly dependent output voltage. At activated output voltage stabilization the fluctuations of the output voltage are balanced. This functions also allows the adaption of motors with a smaller rated voltage to the inverter. In controlled operation this function provides an optimal limit torque characteristic, if the adjusted value corresponds to the inverter input voltage. At deactivated function the limit characteristic is calculated to inverter nominal voltage.

Fig. 6.5.8.a Output voltage stabilization

dS.10 = 1...500 V
501 = off (default)

Example: dS.10 = 230V
no boost adjusted

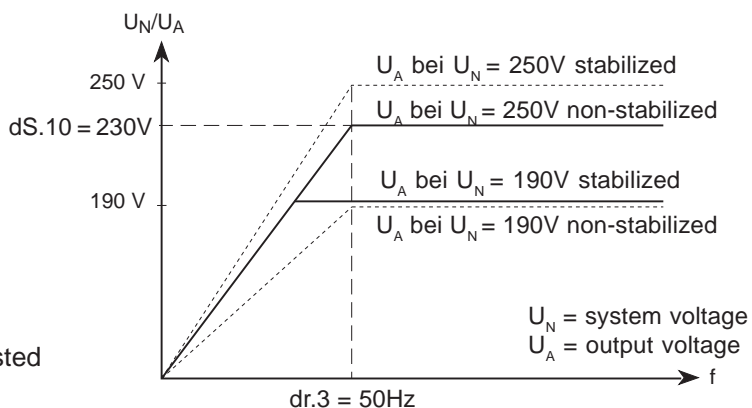
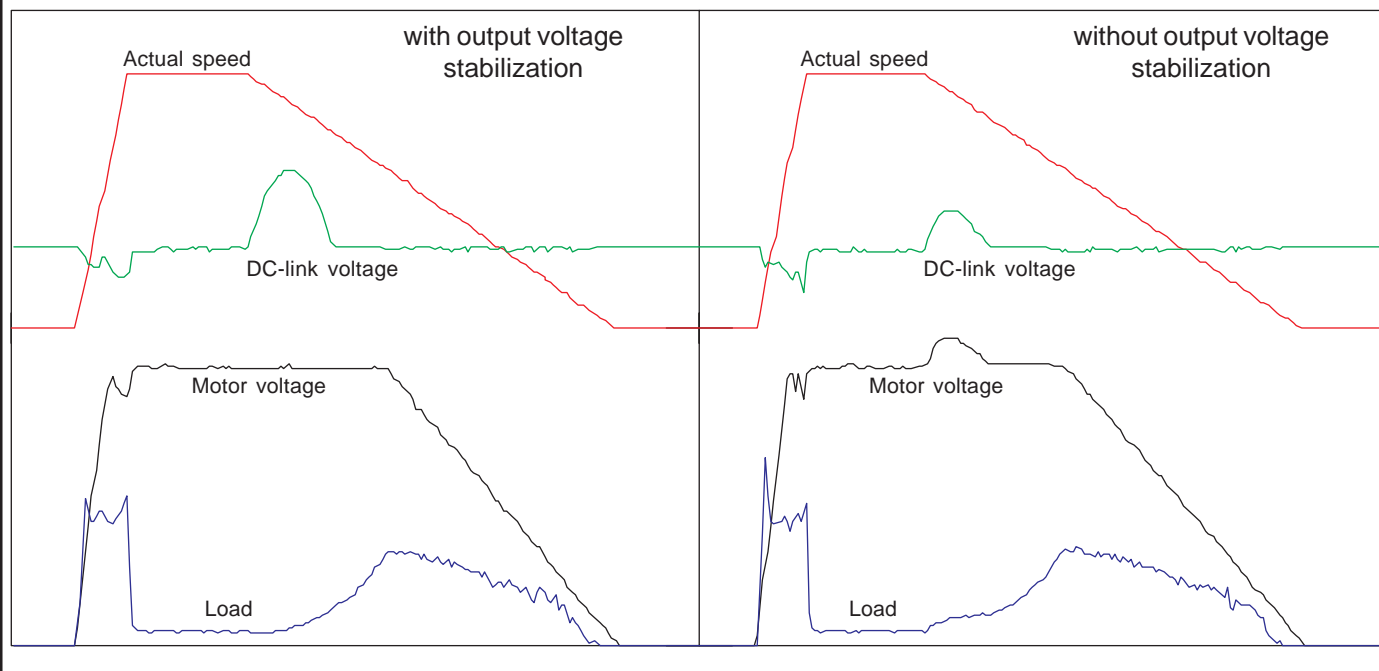

Fig. 6.5.8.b Example: Deceleration of a drive for high-inertia load from 80 Hz (controlled)



6.5.5 Modulation Rate (dS.12) and Overmodulation (dS.14)

Representation of the modulation rate. Since the current control always requires a voltage reserve in order to react to control deviations, the modulation rate should not exceed static approx. 90...95 % (short-time peaks are not critical). To judge the modulation rate at activated output voltage, the value of dS.10 must correspond to the input voltage.

$$\text{or at dS.10 = off} \Rightarrow \begin{matrix} U_{\text{Output}} & \gg & \text{dS.10} * \text{dS.12}/100 \\ & & U_{\text{Output}} & \gg & 0,95 * U_{\text{Input}} * \text{dS.12}/100 \end{matrix}$$

(The calculation of the output voltage applies only to modulation rate < 100 %)

Overmodulation and block modulation can be switched on/off with **dS.14**

dS.14	Overmodulation
0	Over and block modulation switched off
1	Over and block modulation switched on (factory setting)

6.5.6 Operating Frequency (dS.13)

The operating frequency with which the power modules are clocked can be changed in dependence on the application. The max. possible operating frequency as well as the factory setting is defined by the used power stage. Effects and consequences of the operating frequency are listed in the following table:

small operating frequency	high operating frequency
<ul style="list-style-type: none"> - little inverter heating - little leakage current - little switching losses - less radio interferences - improved concentricity at small speed 	<ul style="list-style-type: none"> - less noise development - improved sine-wave simulation - less motor losses - less permanent current at small speed (- reduced OH limit

The operating frequency must be changed in „noP“ status.

dS.13	Function
0	8 kHz
1	16 kHz

A heat sink temperature dependent derating is realized with rated operating frequency of 8 kHz and max. operating frequency of 16 kHz. Derating is only permissible for short-time operating to protect the inverter against overheat.

6.5.7 Controller Structure

6.5.11 Controller structure

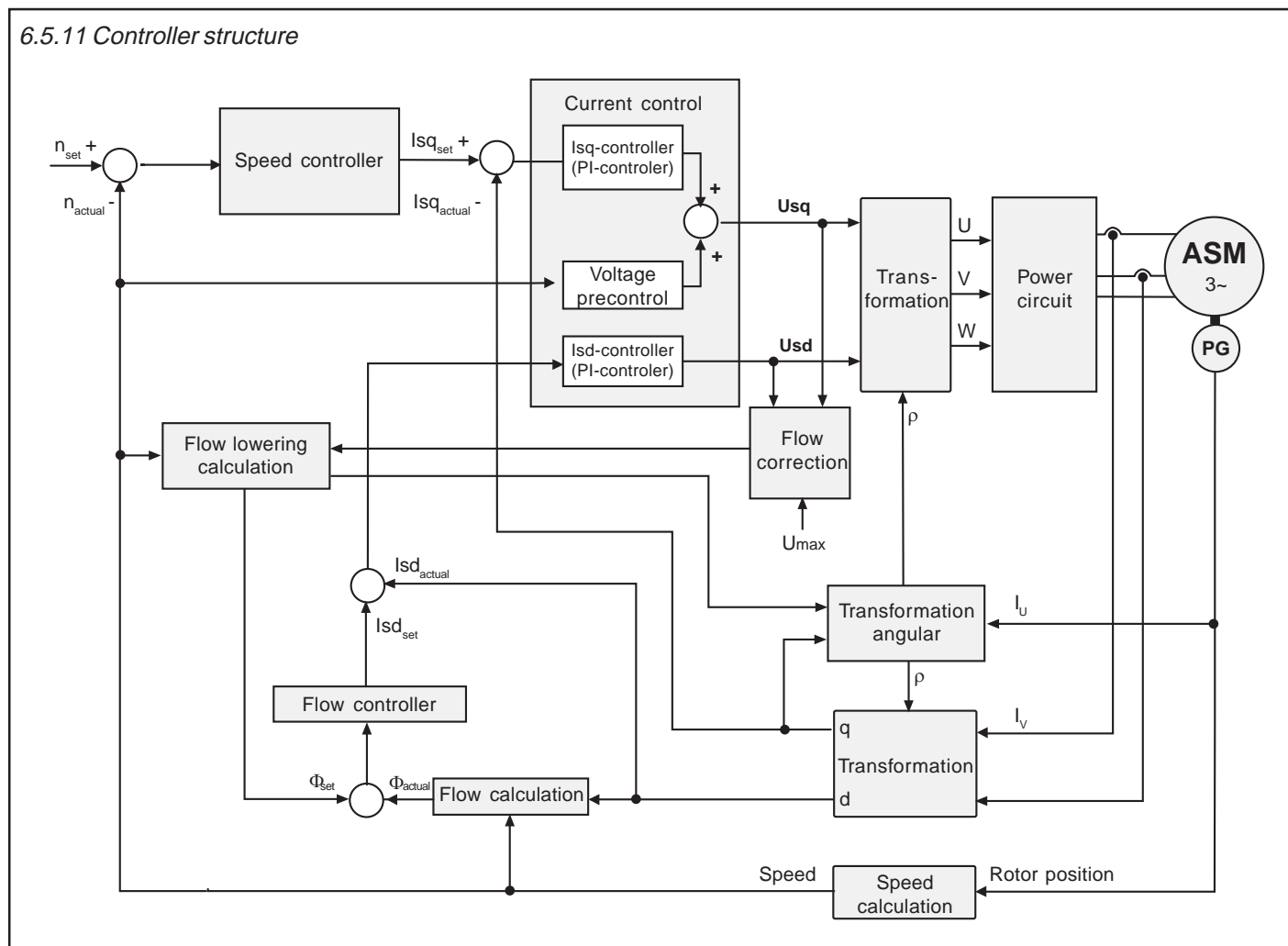

6.5.8 Current Control (Torque Control)

The current control consists of two standard PI-controllers.

- Active current controller (torque controller) dS.0, dS.1 with speed-dependent precontrol dS.9
- Magnetizing current controller dS.5, dS.6

KP active current(dS.0)
KI active current(dS.1)

The basic setting of the controller is done automatically through the motor adaption Fr.10 (see Chapter 6.5.3).

KP magnetizing current (dS.5)
KI magnetizing current (dS.6)
No-load voltage (dS.9)

If in the individual case a fine adjustment should be necessary the proportional gain factor can be adjusted with dS.0 and dS.5. The integral factor is adjusted with dS.1 and dS.6. The precontrol of the active current controller can be changed by means of dS.9.

With ds.5 and dS.6 = „0“ the values for the active current controller become effective for the magnetizing controller too (standard setting).

6.5.9 Speed Control

The speed controller consists of a PI-controller, at which the P-factor is system-deviation-dependent (see picture A) and the I-factor is speed-dependent (see picture B). The torque limits can be adjusted separately for all 4 quadrants.



The limits take effect without hysteresis and without ramp immediately, for that reason different settings can result in torque jumps at a change of the quadrant.

KP speed(CS.0)
KP speed gain (CS.3)
KP speed limit (CS.4)

The proportional factor of the speed controller is adjusted in these parameters. In addition to the standard KP-value a system-deviation-dependent proportional gain can be adjusted with CS.3 and CS.4. With it the dynamic performance can be improved and overshootings can be dampened.

CS.3 defines to what extent the control deviation effects the proportional factor. CS.4 limits the proportional factor.

Exception: If the standard KP-value (CS.0) is larger than the limit value CS.4, then the proportional factor is = CS.0.

These parameters define the integral factor of the speed controller. To achieve a better

Fig. 6.5.13 Mode of functioning of the speed controller

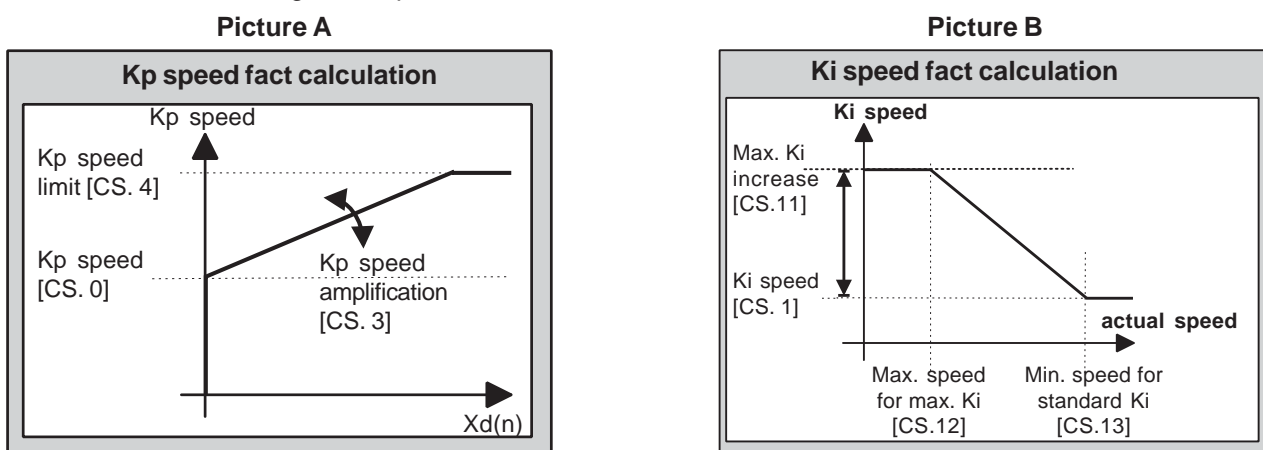

KI speed(CS. 1)
KI offset (CS.11)
Corner speed max. KI (CS.12)
Corner Speed standard KI (CS.13)

speed rigidity at small speed and in standstill the KI-factor can be varied in dependence on the speed (CS.12, CS.13).

- CS. 1 forms the base value
- the maximum KI-value is CS. 1 + CS. 11
- the two corner speeds CS.12 and CS.13 define in which speed range the KI-value is changed

These parameters define the torque limits in the 4 quadrants.

Standstill position control (CS.14)

To improve the standstill rigidity of the drive a standstill position control can be adjusted. The position control becomes active when actual and setpoint speed have reached the value 0 min^{-1} . The position control is deactivated as soon as the setpoint speed has reached a value of $\neq 0 \text{ min}^{-1}$ or when the control release is not given. The setpoint position, onto which the drive controls, is the position value at which the condition actual and setpoint speed = 0 min^{-1} exists for the first time (at given control release).

The proportional factor of the position controller is adjusted in CS.14. A value of 0 deactivates the controller. The definition of the setpoint position takes place at deactivated controller too.

6.5.10 Torque Limitation

If only one torque limitation is necessary for all 4 quadrants (standard condition in speed controlled operation), then the values CS. 7...CS.9 can be set to „off“. Then the torque limit adjusted in CS.6 applies to all 4 operating areas (motoric/generatoric/clockwise and counter-clockwise rotation).

The maximum torque is limited by 2 further factors:

- Torque limit (CS. 6)
- Torque limit counter-clockwise rotation motoric (CS. 7)
- Torque limit clockwise rotation generatoric (CS. 8)
- Torque limit counter-clockwise rotation generatoric (CS. 9)

Fig. 6.5.14 Torque limits

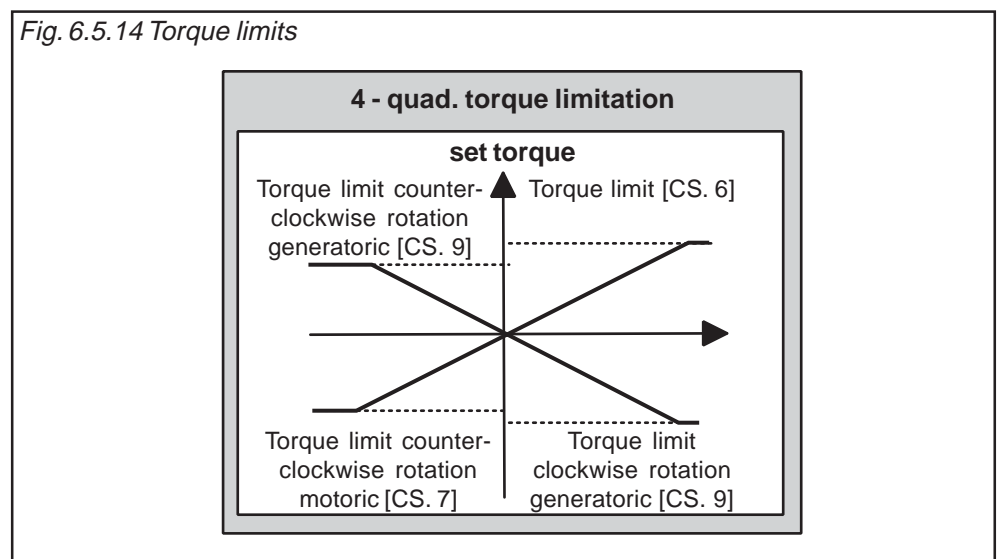

- If the KEB COMBIVERT is dimensioned too small to operate the current that is necessary for the required torque, then the maximum torque is limited automatically.
- From the motor parameters a speed-dependent torque characteristic is calculated.

Rated motor torque (dr. 9)
 max. torque (dr.10)
 Corner speed for max. torque (dr.13)
 max. torque at dr.19 (dr.16)

The motor torque which has been calculated from the motor parameters is displayed in dr.9.

Parameter dr.10 indicates the maximum torque which is achieved in the base speed range. It depends on the hardware current limitation and cannot be altered.

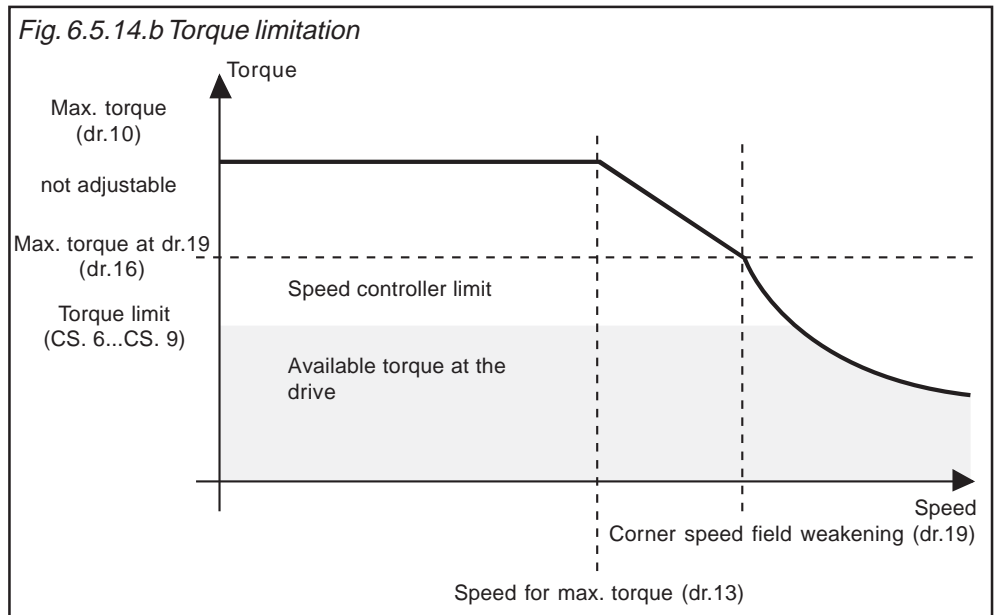

6.5.11 Flux Lowering Calculation

In the base speed range the maximum torque is mainly limited by the hardware current limits of the inverter. For a stable operation the control requires voltage reserves in order to balance currents at any time, therefore the torque that can be reached in the higher speed range is limited by the output voltage. The limit characteristic is adjusted correctly when a voltage reserve of approx. 5...10 % of the rated voltage is available at every operating point.

- Corner speed field weakening (dr.19) In this parameter the speed is adjusted at which the field weakening operation starts.
- Field weakening curve (dr.20) In this parameter the field weakening characteristic is adjusted. The value of 1 means that the flow is lowered after an 1/n function.
- Flux adaption factor (dr.21) With the parameters dr.20, dr.21 the flow characteristic can be adapted to the motor.

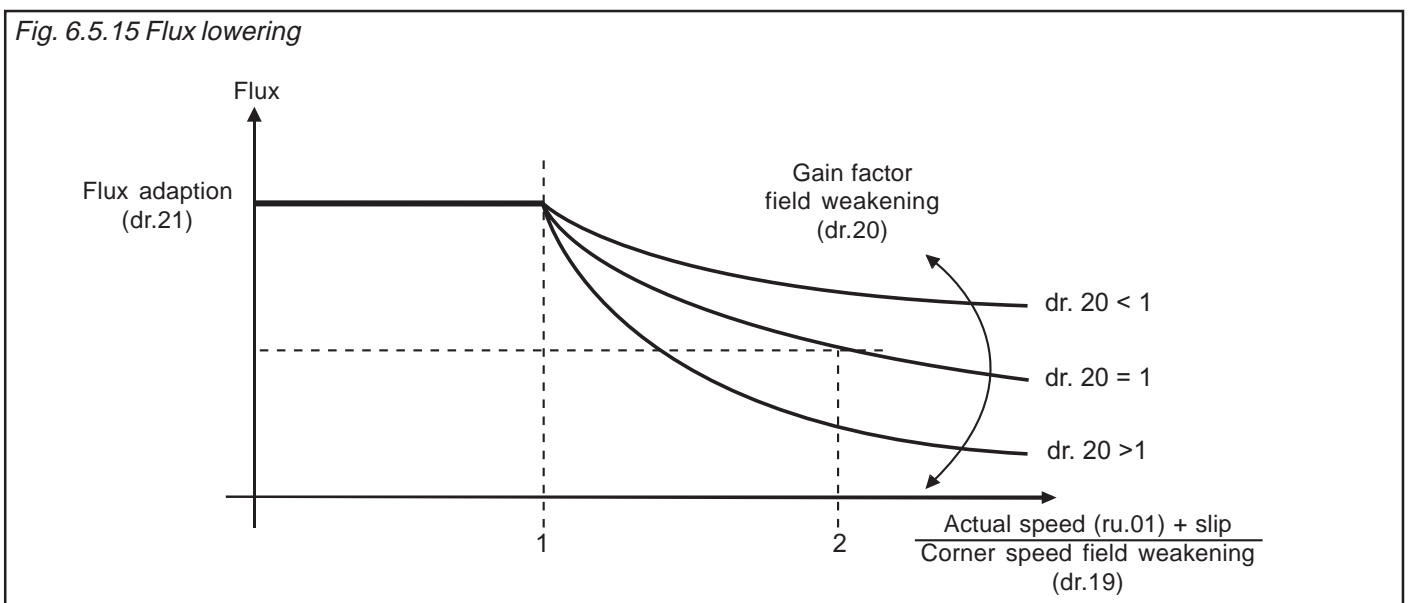

6.5.12 Flow Control

- KP flux (CS.19)
- KI flux (CS.20)
- Magnetizing current limit (CS.21)

The flow control is designed as PI-controller. The factors are adjusted with CS.19 and CS.20, CS.21 contains the limitation. With the setting KP flow (CS.19) = 0 the controller is deactivated. For most applications it is not necessary to activate the flow control. Only in the case of short acceleration times and setpoint speed values within the field weakening range the drive performance can be optimized by activating the flow control. In order to work with motor parameter adaption, the flow control must be activated.

6.5.13 Max. Voltage Control

- Max. voltage Controller (CS.39, CS.40)

The maximum voltage control is a P-controller with subsequent PT1-element for smoothing. The controller tries to limit the voltage in the field weakening range to 100%. This is always possible by the controller in no-load operation, but in the case of dynamic acceleration the drive can reach the voltage limit anyhow.

The usual values for the P-component are 200...500

The smoothing time should be as short as possible, about 100 ms. However, if the current becomes too irregular, values in the range of seconds can be sensible for motors with larger ratings.

At simultaneous use of flow and maximum voltage controllers it often is useful to lessen the flow control actions compared to the calculated value ($1/3 \dots 1/5$ for K_p and K_i) in order to achieve a smooth current in the field weakening range. The calculation is done by Fr.10 = 3...6 (see chapter 6.5.3).

- Flux Controller / Mode (CS.22)

With CS.22 the flux controller is changed to max. voltage control. Operation in the field weakening range is stabilized by this way. This parameter must only be activated when the motor parameter adaption is active. The output voltage in the field weakening range is limited to 100% and a critical increasing is prevented by this.

CS.22	Function
0	Flow controller off, max. voltage controller off
1	Flow controller on, max. voltage controller off
2	Flow controller off, max. voltage controller on
3	Flow controller on, max. voltage controller on

KP U-Max (CS.39) KP-Value of the max. voltage controller

PT1-Time U-Max (CS.40) PT1-Time of the max. voltage controller
If the maximum voltage of the inverter is reached, the max. voltage controller reduces the magnetizing current.

6.5.14 Motor Parameter Adaption

The motor name plate data are only valid for one operating state (generally at operating temperature). With the motor parameter adaption the operational performance of motors $\geq 4\text{kW}$ for the respective operating state (cold...warm... max. temperature) can be optimized. This function should not be activated (because the system can oscillate) for smaller motors or applications which do not reach the torque limit. Parameters dr.50...dr.52 must be entered for activation. Equivalent circuit diagram data listed in picture 6.5.17 must be taken from additional data sheets of the drive or you can inquire the motor manufacturer. This function is only effective from 300 rpm and approx. 10% of the rated current of the inverter.

Motor Parameter Adaption / Activation (CS.10) The adaption in a range of 0 (off) to 65535 can be adjusted with CS.10 (starting value approx. 2000). This adjustment should be controlled in several operating areas.

Motor Parameter Adaption / Activating (CS.10)

CS.10	Function
0	off
1	Modulation on
2	Tr-Adaption

The adaption is switchable in condition „noP“ only.

If the motor shall work with adaption, the value 2 is to be adjusted in parameter CS.10. With the setting 1 the temperature-dependent correction of the rotor time constant is deactivated. This status is for checking purposes only, whether drive and motor model run stable. The activation of the adaption (CS.10 = 1 or 2) affects several other parameters.

- ds.16 the dead time compensation is activated by the adaption
- ds.14 the overmodulation is switched off by the adaption
- ds.13 the switching frequency is switched to 8 KHz
- CS.22 the flow control is switched on

Motor Adaption (Fr.10) With the adjustment of the value Fr.10 = 3 and 4 the equivalent circuit diagram data of a standard motor are loaded with the rating preset under dr.0. The presetting of motor-dependent control parameters depends on the name plate and the equivalent circuit diagram data.

Important: Parameter dr.52 (motor connection) must be adjusted correctly!

By setting the values Fr.10 = 5 and 6 the motor-dependent control parameters are preset.

The equivalent circuit diagram data (dr.48...dr.51) and the mode of interconnection (dr.52) must contain correct values.

In order to activate the adaption, the equivalent circuit diagram data of the motor model must be known. These can be inquire about at the manufacturer or identified by the inverter itself. For the identification of the data through the inverter, the motor must be able to rotate in no-load operation, i.e. the motor must not be connected with any load and speeds within the range of approx. transition speed (dr.16) must be permissible. If that is not possible, it must be resorted to the data from the manufacturer.

If several motors, constructed in the same way, are used, only one motor needs to be identified and the data can be used for the others.

Data from the manufacturer Following proceeding is recommended at the activation of the adaption, if the equivalent circuit diagram data are made available from the manufacturer of the motor (its imperative to observe the sequence!!).

- 1.) Enter name plate data as usual.
- 2.) Write the value 2 or 3 to Fr.10 . The function is the same as with the setting of value 1 or 2 (see page 6.5.4), in addition to it the equivalent circuit diagram data of a standard motor with the appropriate rating (d.r.0) are loaded.
- 3.) Enter the exact motor data of the manufacturer in dr.48...dr.51.
- 4.) Finally write the value 5 or 6 to Fr.10. Thus the controllers are adapted to the new motor data.

The error message „**Data invalid**“ during input over COMBIVIS or „**nco**“ during input over keyboard indicates that an error occurred at the calculation of the internal model size. This is probably due to the nput of wrong equivalent circuit diagram data.

Identification through the inverter There are two kinds of indentification by the inverter. A complete identification (ds.18 = 200) and the identification of the resistance (ds.18 = 440). In the case of the resistance identification the motor stands still, but does not generate any torque. The resistance identification is to be recommended only, if the motor is allowed to rotate and approx. values for the inductances are known. Otherwise the complete identification is necessary for the adaption.



The motor must not be connected with any load. The motor must be able to rotate with a speed of approx. transition speed. During the indentification the inverter generates test signals that can cause motor noises (pinging).

- Procedure
- 1.) The control release must be open (Status „nOP“)
 - 2.) Enter the data of the name plate und start up the drive in standard operation (CS.10 =), i.e. check speed feedback.
Switch over the drive into controlled operation (CS.23 = 1) and ensure, that the speed controller does not swing and the drive runs.
 - 3.) Fr.10 = 3 or 4
Function same as with setting of value 1 or 2 (see page 6.5.4), additionally the equivalent circuit diagram data of a standard motor with the corresponding rating (dr.0) are loaded.
In so doing the adjustment of the current control is adapted.
It is absolutely necessary to adjust the correct motor wiring in dr.52 !
 - 4.) Ensure that following adjustments are programmed in the inverter:
 - CS.23 = 1, controlled operation
 - long acceleration and deceleration times, depending on the rating of the inverter between 5s and 30 s
 - with digital speed setting or by terminal strips the rotation direction must be given before starting the identification

- 5.) Start the identification by writing to ds.18.
- 6.) Close control release
- 7.) Keep track of the process of identification in parameter ds.18.

Equivalent-Circuit
Identification (ds.18)

ds.18	Function
0	no identification
1	wait for ST
2	wait until 75 % of the corner speed are reached
3	Tr-Ident-Initialising
4-8	Tr-Identification
9	Speed set value 0
10	wait until speed at 0
11	wait for ST
12	Ts-Ident-Initialising
13-15	Ts-Identification
16	remove ST
-1	Identification performed

- 8.) Open the control release if ds.18 is = 16.
ATTENTION: The inverter executes a reinitialization, i.e. it behaves as after Power-On.
- 9.) Finally write the value 4 or 5 to parameter Fr.10. Thus the control parameters are adapted to the newly identified motor parameters.

If the inverter identifies the equivalent circuit diagram data itself, it can lead to differences to the manufacturer specifications.

Possible reason for different values of the main inductance L_{μ} is the saturation. The manufacturer specification may refer to another magnetizing current than the rated magnetization of the inverter.

At the identification of the stator resistance the inverter takes into account voltage drops, that occur internally as well as on cables and terminals. Thus the identified value will be larger than the manufacturer specifications.

Error messages If the inverter detects an error during the identification (value outside the permissible range), it switches off with the error message E.cdd. In order to reset this error, the motor data must be set back to a valid range. The simplest way is to preset Fr.10 = 3 or 4. Alternatively the error can be reset by adjusting the old equivalent circuit diagram data and **subsequent restart** of the unit.

The identification takes about 1-4 minutes (depending on the motor size). If after this time parameter ds.18 has not reached the value 16, the identification should be aborted by opening the control release. The identification should also be aborted, if the acceleration to 75 % of the transition speed does not function, the drive oscillates or draws too much current.

Picture 6.5.9 Equivalent circuit diagram of a motor

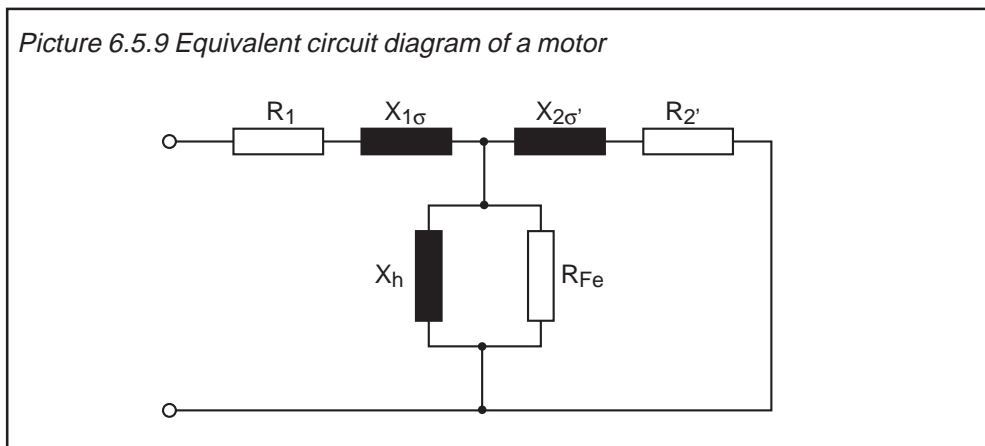

Rotor Resistance (dr.48) In accordance with picture 6.5.9 the rotor resistance R_2' in a range of 0,000...32,767 Ω is entered in parameter dr.48.

Magnetic Inductance (dr.49) In accordance with picture 6.5.9 the magnetic inductance L_h in a range of 1...3276,7 mH is entered in parameter dr.49.

Stator Resistance (dr.50) In accordance with picture 6.5.9 the stator resistance R_1 in a range of 0,000...32,767 Ω is entered in parameter dr.50.

Leakage Inductance (dr.51) In accordance with the following formula the leakage inductance σL_s in a range of 0,00...327,67 mH is entered in parameter dr.51.

$$\sigma L_s = \frac{1}{\omega} \left((X_{1\sigma} + X_h) - \frac{X_{h^2}}{(X_{2\sigma'} + X_h)} \right)$$

or

$$\sigma L_s = (L_{1\sigma} + L_h) - \frac{(L_{h^2})^2}{(L_{2\sigma'} + L_h)} \approx L_{1\sigma} + L_{2\sigma'}$$

Motor Connection (dr.52) Adjustment of the connection (star/delta).

dr.52	Motor connection
0	star
1	delta (factory setting)

To be taken into account at the evaluation of the manufacturer data:

The motor model requires the phase resistances and inductances. However, in part only linked values (also called conductor-conductor-values or R_{UV} and L_{UV}) are specified by the manufacturer.

Conversions

Star connection: Phase values = linked values / 2

Delta connection: Phase values = linked values x 1,5

Instead of the inductances (L) also reactances (X) can be specified.

Alternative Terms The resistors R1 and R2 may be termed as R_s and R_r , too.

Adaption factor (ds.15) Display of the adaption intervention.

Range of values: off (adaption off)
0,1% ... 100,0% (no intervention)

At ds.15 = 0 : off the adaption is not active.

Delay time flux build-up (ds.17) If ds.17 is activated, the setpoint value for speed and torque is maintained on 0 until the flux (the magnetic field) is build up in the motor.

6.5.15 Torque Control

There are two controlled conditions at torque control – torque and speed. Parameter An.13 (Aux-function) must be adjusted with value „6“ to activate the torque control. The function of the analog inputs is changed as follows:

REF2 (X2.16 / X2.17) => **Input of the speed**

10 V is correspond to the max. speed SP.5
(negative values are interpreted with 0)

REF1 (X2.14 / X2.15) => **Torque set value**

$\pm 10V$ is correspond to the torque limit CS.6
(the sign determines the direction of rotation)
If the torque limit is higher than the max. torque (see characteristic curve picture 6.5.14.b), the torque set value is limited to the max. torque. Scan time 128 ms.

6.5.18 Torque input via REF1

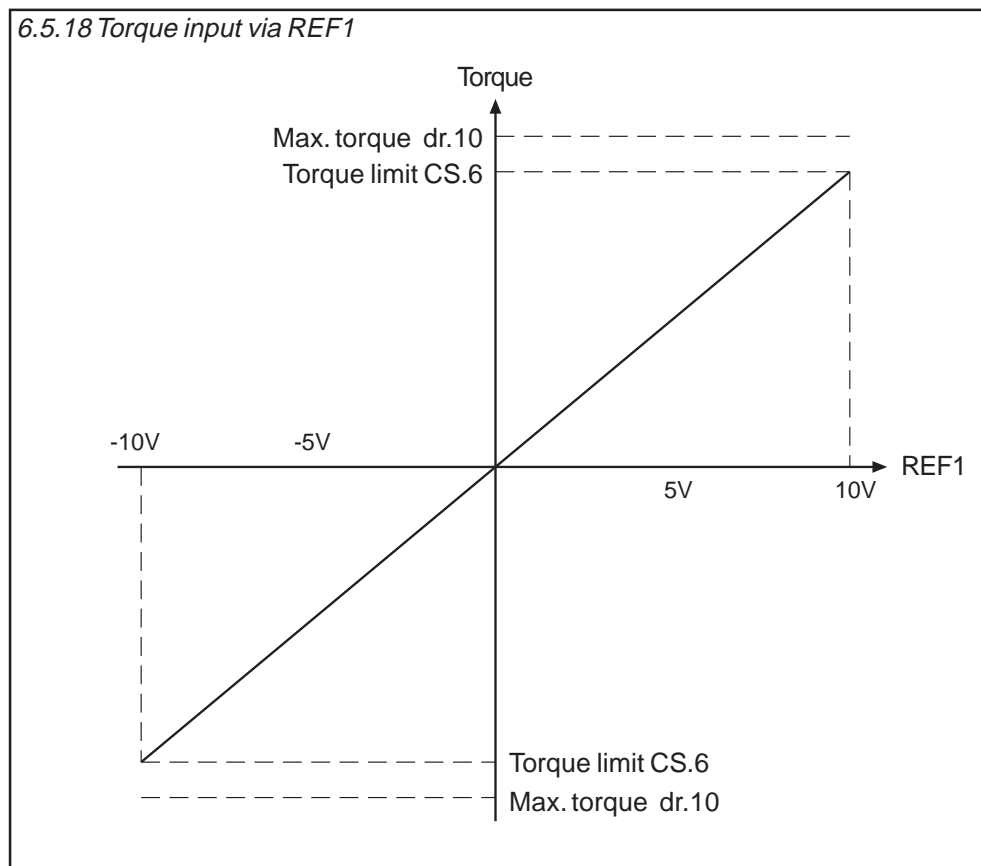

6.5.18.a Torque limit higher than max. torque

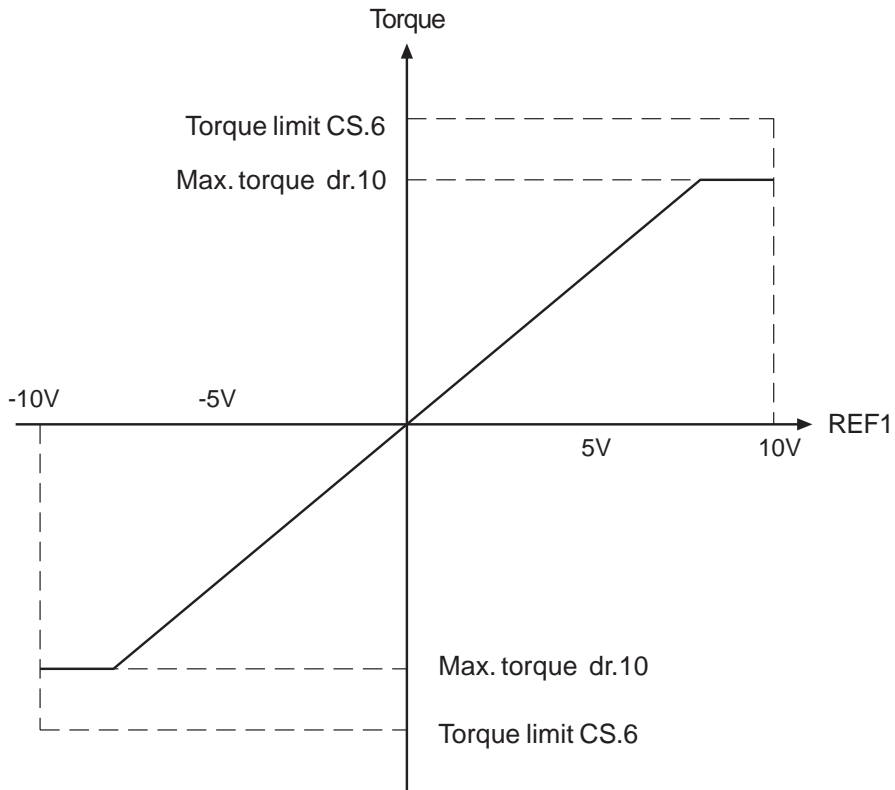

6.5.18.b Torque input via REF1 with Offset 20% (An.4)

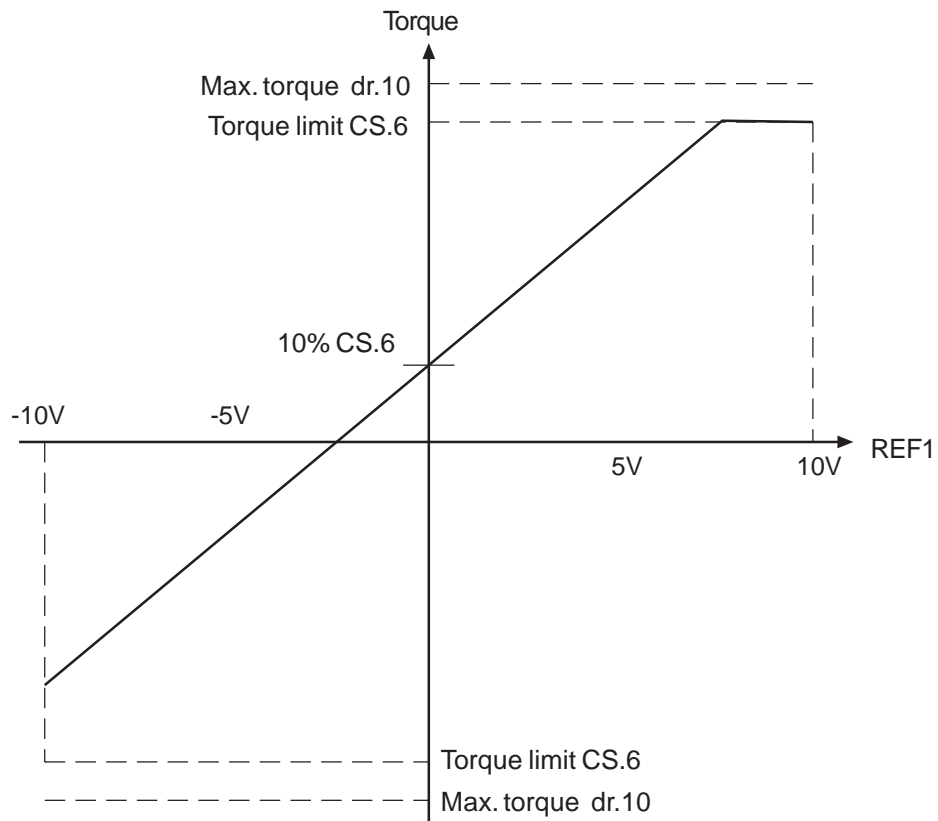

6.5.18.c Torque input via REF1 with Offset 20% (An.4) and Gain factor 2 (An.3)

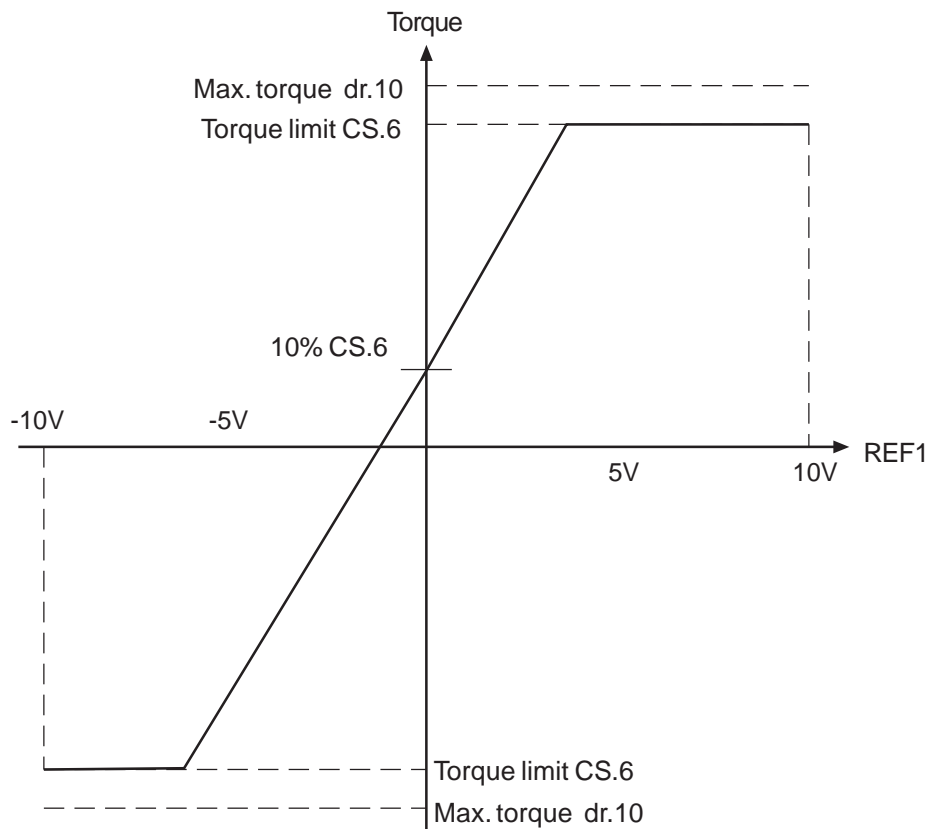







6.5.16 Torque inertia (dr.56)

The total moment of inertia can be preset here. Then the inverter precontrols the necessary acceleration torque directly.

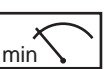
6.5.17 Used Parameters

Param.	Adr.	RW	PROG	ENTER	min	max	Step	default	
dr.0	2400h	✓	-	✓	0,01 kW	75 kW	0,01 kW	-	default value dep. on inverter size
dr.1	2401h	✓	-	✓	100 rpm	14000 rpm	1 rpm	-	default value dep. on inverter size
dr.2	2402h	✓	-	✓	0,1 A	1,1 x In.01	0,1 A	-	default value dep. on inverter size
dr.3	2403h	✓	-	✓	20 Hz	300 Hz	1 Hz	50 Hz	-
dr.4	2404h	✓	-	✓	0,05	1,00	0,01	-	default value dep. on inverter size
dr.9	2409h	-	-	-	0,1 Nm	1000,0 Nm	0,1 Nm	-	-
dr.10	240Ah	-	-	-	0,1 Nm	1000,0 Nm	0,1 Nm	-	-
dr.12	240Ch	✓	-	✓	100 V	500 V	1 V	400 V	-
dr.13	240Dh	✓	-	✓	0,0 rpm	14000 rpm	0,5 rpm	1000 rpm	-
dr.16	2410h	✓	-	✓	0,0	5 x dr.09	0,1	1,5 x dr.09	-
dr.19	2413h	✓	-	✓	200,0 rpm	14000 rpm	0,5 rpm	1300 rpm	-

Param.	Adr.								
dr.20	2414h	✓	-	✓	0,1	2,00	0,01	1,20	-
dr.21	2415h	✓	-	✓	25 %	250 %	1 %	100 %	-
dr.48	2430h	✓	-	✓	0,001	32,676 Ohm	0,001	-	dependent by inverter size
dr.49	2431h	✓	-	✓	10,0	3276,7 Ohm	0,1	-	dependent by inverter size
dr.50	2432h	✓	-	✓	0,001	32,767Ohm	0,001	-	dependent by inverter size
dr.51	2433h	✓	-	✓	0,00	327,67mH	0,01	-	dependent by inverter size
dr.52	2434h	✓	-	✓	0	1	1	1	0: delta 1:star connection
dr.56	2438h	✓	-	✓	0	dr.10	0,1	-	dependent by inverter size
dS.0	2F00h	✓	-	-	1	65535	1	1500	-
dS.1	2F01h	✓	-	-	1	65535	1	500	-
dS.5	2F05h	✓	-	-	0	65535	1	-1 : off	-
dS.6	2F06h	✓	-	-	0	65535	1	-1 : off	-
dS.9	2F09h	✓	-	-	0 %	100 %	0,1 %	75 %	-
dS.10	2F0Ah	✓	-	✓	180 V	500 V	1 V	501 : off	-
dS.11	2F0Bh	✓	-	-	0,0 %	25,5 %	0,1 %	2,0 %	-
dS.12	2F0Ch	-	-	-	0 %	100 %	1 %	-	-
dS.13	2F0Dh	✓	-	✓	0	1	1	0	-
dS.14	2F0Eh	✓	-	✓	0	1	1	1	-
dS.15	2F0Fh	-	-	-	0,0 : off	100,0%	0,1%	-	-
dS.16	2D10h	✓	-	-	0 : off	1 : on	1	0 : off	-
dS.17	2D11h	✓	-	-	0 : off	1 : on	1	0 : off	-
dS.18	2D12h	✓	-	-	0	9999	1	0	-
Fr.10	270Ah	✓	-	✓	0	2	1	0	-
CS.0	2D00h	✓	✓	-	0	32767	1	400	-
CS.1	2D01h	✓	✓	-	0	32767	1	200	-
CS.3	2D03h	✓	-	-	0	32767	1	0	-
CS.4	2D04h	✓	-	-	0	32767	1	0	-
CS.6	2D06h	✓	✓	-	0,0 Nm	dr.10	0,1 Nm	dr.10	-
CS.7	2D07h	✓	✓	-	-0,1 : off	dr.10	0,1 Nm	-0,1 : off	-
CS.8	2D08h	✓	✓	-	-0,1 : off	dr.10	0,1 Nm	-0,1 : off	-
CS.9	2D09h	✓	✓	-	-0,1 : off	dr.10	0,1 Nm	-0,1 : off	-
CS.10	2D0Ah	✓	-	-	0	65535	1	0	-
CS.11	2D0Bh	✓	-	-	0	65535	1	0	-
CS.12	2D0Ch	✓	-	-	0,0 rpm	14000 rpm	0,5 rpm	10,0 rpm	-

Param.	Adr.								
CS.13	2D0Dh	✓	-	-	0,0 rpm	14000 rpm	0,5 rpm	500,0 rpm	-
CS.14	2D0Eh	✓	-	-	0	65535	1	0	-
CS.19	2D13h	✓	-	-	0 : off	65535	1	0 : off	-
CS.20	2D14h	✓	-	-	1	65535	1	1	-
CS.21	2D15h	✓	-	-	0,0 A	In.01	0,1 A	0,0	-
CS.22	2D16h	✓	-	✓	0	1	1	0	-
CS.23	2317h	✓	✓	✓	0 : off	1	1	0 : off	-
CS.39	2D27h	✓	-	-	1	65535	1	0 : off	-
CS.40	2D28h	✓	-	-	0,01s	50,00s	0,01s	1,00s	-

Chapter 6	Section 5	Page 24	Date 18.12.02	Name: Basis KEB COMBIVERT F4-F	© KEB Antriebstechnik, 2002 All Rights reserved
---------------------	---------------------	-------------------	------------------	--	--

- 1. Introduction
- 2. Summary
- 3. Hardware
- 4. Operation
- 5. Parameter
- 6. Functions**
- 7. Start-up
- 8. Special Operation
- 9. Error Assistance
- 10. Project Planning
- 11. Networks
- 12. Applications
- 13. Annex

- 6.1 Operating and Unit Data
- 6.2 Analog In- and Outputs
- 6.3 Digital In- and Outputs
- 6.4 Set Value and Ramp Adjustment
- 6.5 Motor Data and Controller Adjustment
- 6.6 Keep on Running Functions**
- 6.7 Parameter Sets
- 6.8 Special Functions
- 6.9 Encoder Interface
- 6.10 Synchronous Control
- 6.11 Positioning Module
- 6.12 CP-Parameter Definition

- 6.6.1 Thermal Motor Protection 3
- 6.6.2 Electronic Motor Protection 3
- 6.6.3 Thermal Inverter Protection 5
- 6.6.4 Power-Off-Function 5
- 6.6.5 External Error Control Procedure 6
- 6.6.6 Watchdo-Time 6
- 6.6.7 Limit Switch 6
- 6.6.8 Braking Torque / Emergency Stop, Emergency-Stop-Ramp . 7
- 6.6.9 Automatic Restart and Speed Search 7
- 6.6.10 Used Parameters 8

Chapter 6	Section 6	Page 2	Date 22.10.02	Name: Basis KEB COMBIVERT F4-F	© KEB Antriebstechnik, 2002 All Rights reserved
---------------------	---------------------	------------------	------------------	--	--

6.6 Keep on Running Functions

The protective functions protect the inverter against switch off through overcurrent, overvoltage as well as thermal overloading. Furthermore, you can restart the drive automatically after a fault (Keep-on-Running).

Attention! the protective functions refer exclusively to software functions, which possibly may not respond in case of a defective unit.

6.6.1 Thermal Motor Protection

The KEB COMBIVERT allows the thermal monitoring of the motor. For that the thermal contact or temperature sensor is connected to the terminals OH/OH of the power stage.

If the thermal contact breaks contact or if the temperature sensor rises above the response resistor, then the switching condition 7 (PTC-warning) is set. Now a digital output can be set with do.1...do.8 (see Chapter 6.3).

E.dOH Switch-off Delay (Pn.16)

After expiration of an adjusted time (Pn.16) in the range of 0...120s the inverter switches to E.dOH. The behaviour in this time is defined with Pn.25.

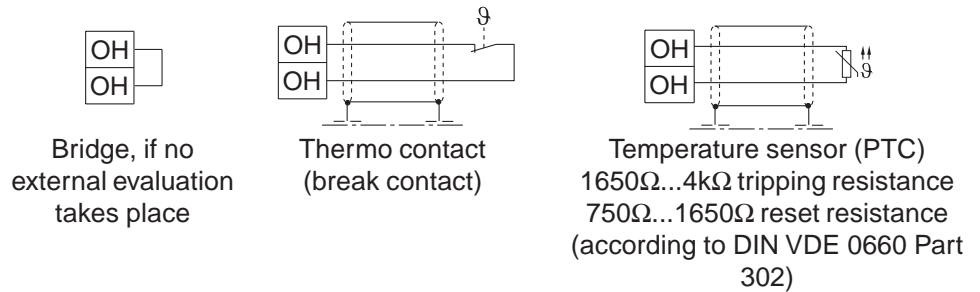

Reaction to E.dOH (Pn.25)

Pn.25	Display	Reaction	Restart
0	E.dOH	Immediate disabling of modulation	Remove fault; Actuate reset
1	A.dOH	Quick stopping / disabling of modulation after reaching speed 0	
2	A.dOH	Quick stopping / holding torque at speed 0	
3	A.dOH	Immediate disabling of modulation	Automatic reset, if the fault is no longer present
4	A.dOH	Quick stopping / disabling of modulation after reaching speed 0	
5	A.dOH	Quick stopping / holding torque at speed 0	
6	none	No effect on the drive: !Fault is being ignored!	- inapplicable-

6.6.2 Electronic Motor Protection

The motor protective function protects the connected motor against thermal destruction caused by high currents. The function corresponds largely to mechanical motor protective components, additionally the influence of the motor speed on the cooling of the motor is taken into consideration. The load of the motor is calculated from the measured apparent current (ru.9) and the adjusted rated motor current (dr.2).

For motors with separately driven fan or at rated speed of a self-ventilated motor following tripping times (VDE 0660, Part 104) apply:

1,2	•	I_n	⇒	2 hours
1,5	•	I_n	⇒	2 minutes
2	•	I_n	⇒	1 minute
8	•	I_n	⇒	5 seconds

Fig. 6.6.1 Principle of electronic motor protective function

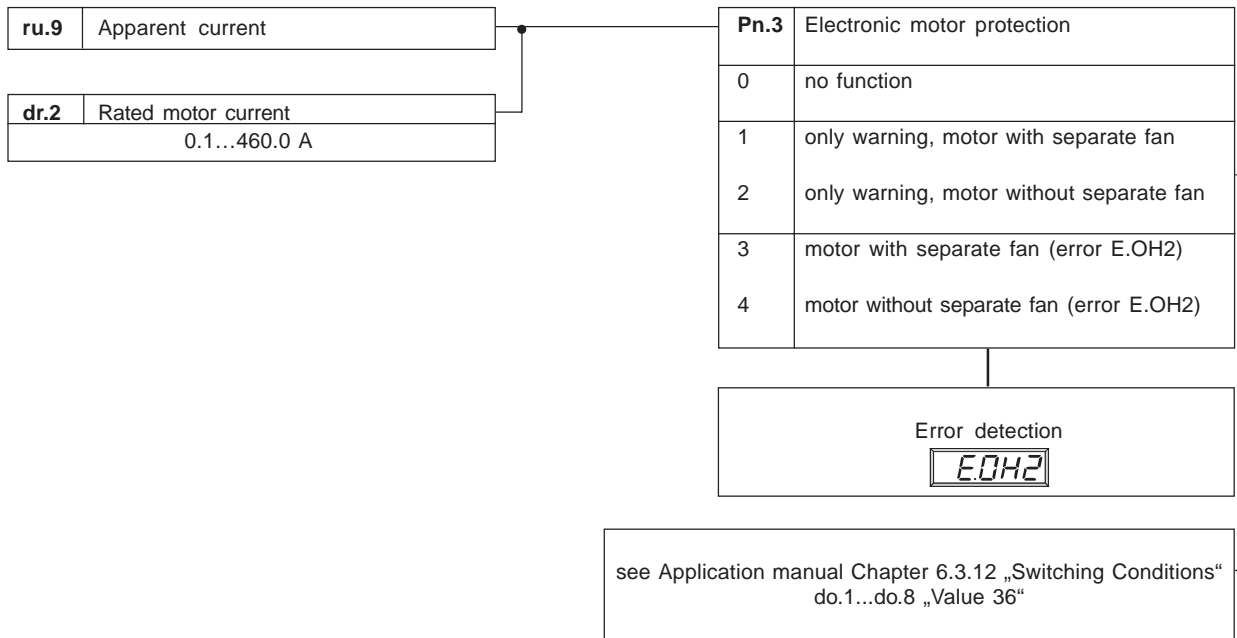
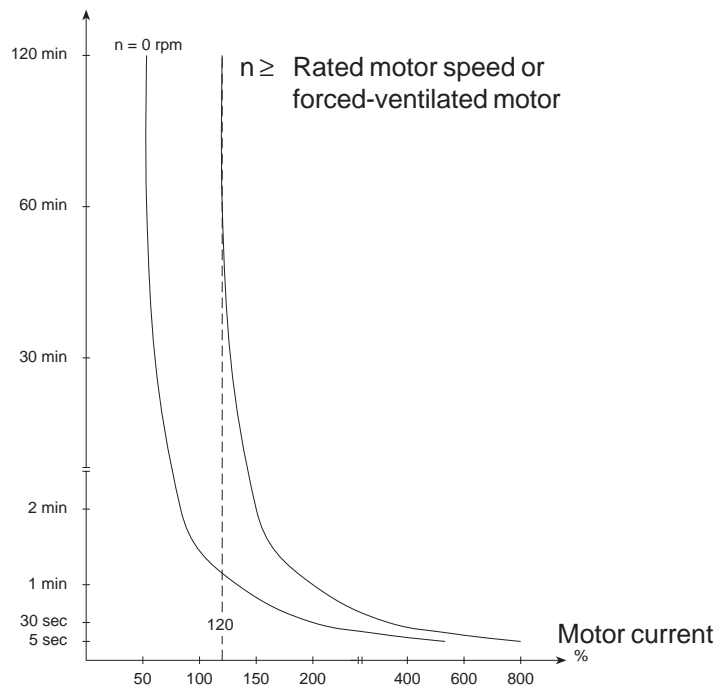

Fig 6.6.2 Tripping times of motor protective function

For self-ventilated motors the tripping times decrease with the speed of the motor (see picture). The motor protective function acts integrating, i.e. times with overload on the motor are added, times with underload are subtracted. After triggering the motor protective function, the new tripping time is reduced to 1/4 of the specified value, if the motor has not been operated for an appropriate time with underload.

Tripping time



6.6.3 Thermal Inverter Protection

To protect the inverter against thermal overloading, e.g. in case of insufficient cooling, the heat sink is monitored by means of a temperature sensor. If the heat sink temperature rises above 70...90°C, depending on the power stage, then the switching condition 26 (overtemperature warning) is set internally. Now a digital output can be set with do.1...do.8 (see Chapter 6.3). As long as the temperature does not drop below the tripping level, the inverter switches after 10s to one of the following fault routines, which are defined with Pn.26:

Reaction to E.OH during prewarning time (Pn.26)

Pn.26	Display	Reaction	Restart
0	E. OH	Immediate disabling of modulation	Remove fault; Actuate reset
1	A. OH	Quick stopping / disabling of modulation after reaching speed 0.	
2	A. OH	Quick stopping / Holding torque at speed 0	
3	A. OH	Immediate disabling of modulation	Automatic reset, if the fault is no longer present
4	A. OH	Quick stopping / disabling of modulation after reaching speed 0	
5	A. OH	Quick stopping / holding torque at speed 0	
6	none	No effect on the drive !Fault is being ignored!	- inapplicable-

6.6.4 Power-Off Function

The duty of the Power-Off function is the controlled deceleration of the drive until standstill in case of undervoltage (e.g. due to a power failure). At that the kinetic energy of the rotating drive is used to support the inverter DC-link voltage. Thus the inverter remains in operation and the drive can be stopped in a controlled manner. Especially at parallel-running drives (e.g. in textile machines) the uncontrolled deceleration of the motors and possible consequences (e.g. thread breakage) can be avoided with that.

Power-Off / Starting voltage (Pn.17)

With Pn.17 the Power-Off function is activated and the DC-link voltage is adjusted, at which the function shall be triggered.

198	Power-Off function disabled (factory setting)
199...800	Manual adjustment of the starting voltage in Volt. For a safe operation the adjusted starting voltage must be at least 50 V above the UP-level (UP: 400V-class=360V; 230V-class=210V DC)

The starting voltage adjusted in this way is now constantly compared with the actual value of the DC-link voltage. If the actual value drops below the setpoint value the Power-Off function is activated.

Power-Off / Mode (Pn.33)

Pn.33 defines the behaviour of the drive after the tripping of the Power-Off function and on reaching 0 Hz.

1	Modulation off
2	Holding torque (factory setting)

In order for the drive to restart the error must be removed and reset must be actuated.

6.6.5 External Error Control Procedure

With the external error control procedure units of other manufacturers can take direct influence on the drive. In order to activate the error control procedure a digital input di.3...di.12 must be assigned with the value „3“. The behaviour at tripping of an external fault is defined with Pn.20 according to following table:

Reaction to E. EF (Pn.20)

Pn.20	Display	Reaction	Restart
0	E. EF	Immediate disabling of modulation	Remove fault; Actuate reset
1	A. EF	Quick stopping / disabling of modulation after reaching speed 0	
2	A. EF	Quick stopping / holding torque at speed 0	
3	A. EF	Immediate disabling of modulation	Automatic reset, if the fault is no longer present
4	A. EF	Quick stopping / disabling of modulation after reaching speed 0	
5	A. EF	Quick stopping / holding torque at speed 0	
6	keine	No effect on the drive; !Fault is being ignored!	- inapplicable -

6.6.6 Watchdog-Time (ud.8)

To keep a constant check on the communication, it is possible ,after the expiration of an adjustable time without incoming telegrams, to trigger an error message of the inverter. By adjusting the value 0 (off) the function can be deactivated. The behaviour at tripping of the fault message is defined with Pn.23 according to following table:

Reaction to E.bus (Pn.23)

Pn.23	Display	Reaction	Restart
0	E.buS	Immediate disabling of modulation	Remove fault; Actuate reset
1	A.buS	Quick stopping / disabling of modulation after reaching speed 0.	
2	A.buS	Quick stopping / Holding torque at speed 0	
3	A.buS	Immediate disabling of modulation	Automatic reset, if the fault is no longer present
4	A.buS	Quick stopping / disabling of modulation after reaching speed 0	
5	A.buS	Quick stopping / holding torque at speed 0	
6	none	No effect on the drive !Fault is being ignored!	- inapplicable-

6.6.7 Limit Switch (Pn.24)

Reaction to limit switch (Pn.24)

Pn.24	Display	Reaction	Restart
0	E.SLx	Immediate disabling of modulation	Remove fault; Actuate reset
1	A.SLx	Quick stopping / disabling of modulation after reaching speed 0	
2	A.SLx	Quick stopping / holding torque at speed 0	
3	A.SLx	Immediate disabling of modulation	Automatic reset, if the fault is no longer present
4 ^{*1}	A.SLx	Quick stopping / disabling of modulation after reaching speed 0	
5 ^{*1}	A.SLx	Quick stopping / holding torque at speed 0	
6	keine	No effect on the drive; !Fault is being ignored!	- inapplicable -

It is necessary for the values, to adjust the emergency stop/braking torque (Pn.60), the positioning speed and the lug length (or the diameter at the initiator) of the limit switch, that the drive stops at the limit switch.

6.6.8 Braking torque / Emergency stop, Emergency-Stop-Ramp (Pn.60, Pn.63)

After the tripping of the Power-Off function the drive is decelerated with the torque adjusted in Pn.60. Independent of the adjusted braking torque the torque limits adjusted in CS.5/CS.7 cannot be exceeded. Pn.60 applies to every abnormal Stop-function and is adjustable in the range of 0,0...5 x rated torque (factory setting 29,4 Nm). For all abnormal stop-conditions, that shall execute a fast stop, a ramp can be adjusted here. The motor is not decelerated with the torque limit adjusted in Pn.60, but executes the fast stop automatically along the adjusted ramp time. The ramp time refers to 1000rpm.

6.6.9 Automatic Restart and Speed Search

With automatic restart the inverter can reset errors automatically. The function can be activated separately for different errors with Pn.0 and Pn.1.

! Because of the automatic restart of the machine corresponding protective measures must be provided for the operating personnel and the machine.

The function speed search reduces the torque impulse that occurs when switching onto a coasting motor. After the function is activated by selecting the starting condition (Pn.7), the ramp starts with the actual motor speed and accelerates the drive with the adjusted ACC-ramp to the setpoint value. At disabled speed search the ramp starts with the setpoint value 0. This means, the drive is decelerated with max. torque and then accelerated again. The function works only in controlled operation (CS.23=1).

Fig. 6.6.3 Parameter survey speed search

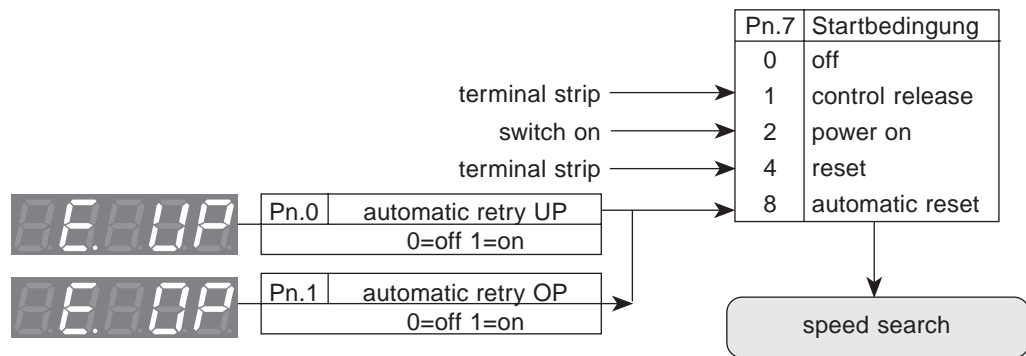
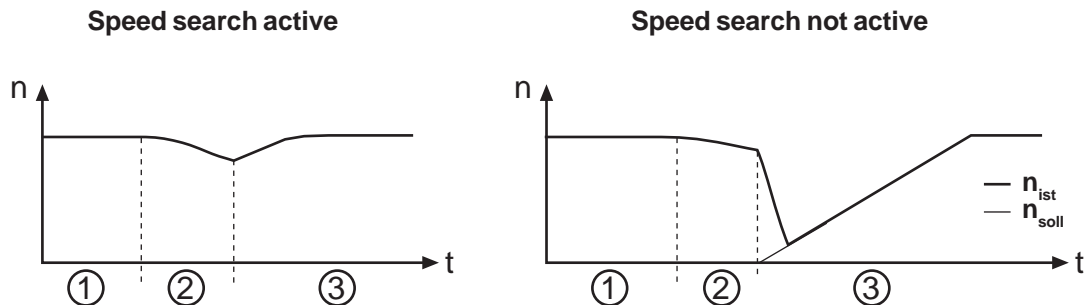

Fig. 6.6.4 Principle of speed search



- 1) Normal operating state
- 2) Modulation disabled => Motor decelerates uncontrolled
- 3) Modulation enabled again => the setpoint speed increases corresponding to the adjusted acceleration ramp and starts with $n_{soll} = n_{ist}$

- 1) Normal operating state
- 2) Modulation disabled => Motor decelerates uncontrolled
- 3) Modulation enabled again => The setpoint speed increases corresponding to the adjusted acceleration ramp starting with $n_{soll} = 0$. At that the motor is decelerated with max. torque until the actual speed has reached the setpoint speed. Afterwards it is accelerated to the setpoint speed.

6.6.10 Used Parameters

Param.	Adr.	R/W	PROG.	ENTER	min	max	Step	default	
Pn.0	2200h	✓	-	-	0	1	1	0	-
Pn.1	2201h	✓	-	-	0	1	1	0	-
Pn.3	2203h	-	-	-	0	4	1	0	-
Pn.7	2207h	✓	✓	-	0	15	1	8	bit-coded
Pn.16	2210h	✓	-	-	0 s	120 s	1 s	0 s	-
Pn.17	2211h	✓	-	-	198, 199, 200	800 V	1	198 (off)	198 : off, 199 : auto
Pn.20	2214h	✓	-	✓	0	6	1	0	-
Pn.23	2217h	✓	-	✓	0	6	1	6	-
Pn.24	2218h	✓	-	✓	0	6	1	6	-
Pn.25	2219h	✓	-	✓	0	6	1	6	-
Pn.26	221Ah	✓	-	✓	0	6	1	6	-
Pn.33	2221h	✓	-	-	0	127	1	2	bit-coded
Pn.60	223Ch	✓	-	✓	0,0	5 x dr.09	0,1	-	Nm
Pn.63	223Fh	-	-	-	0 s	10 s	0,01 s	0	-
ru.09	2009h	-	-	-	0 A	-	0,1 A	-	max. value dep. by inverter size
dr.02	2402h	✓	-	✓	0,1 A	500 A	0,1 A	-	Default value dep. by inverter size

- 1. Introduction
- 2. Summary
- 3. Hardware
- 4. Operation
- 5. Parameter
- 6. Functions
- 7. Start-up
- 8. Special Operation
- 9. Error Assistance
- 10. Project Planning
- 11. Networks
- 12. Applications
- 13. Annex

- 6.1 Operating and Unit Data
- 6.2 Analog In- and Outputs
- 6.3 Digital In- and Outputs
- 6.4 Set Value and Ramp Adjustment
- 6.5 Motor Data and Controller Adjustment
- 6.6 Keep on Running Functions
- 6.7 Parameter Sets
- 6.8 Special Functions
- 6.9 Encoder Interface
- 6.10 Synchronous Control
- 6.11 Positioning Module
- 6.12 CP-Parameter Definition

- 6.7.1 Non-programmable Parameters 3
- 6.7.2 Copying of Parameter Sets 3
- 6.7.3 Selection of Parameter Sets ... 4
- 6.7.4 Locking of Parameter Sets 6
- 6.7.5 Parameter Set ON and OFF Delay 7
- 6.7.8 Used Parameters 7

6.7 Parameter Sets

The KEB COMBIVERT comprises 8 parameter sets (0...7), i.e. all programmable parameters exist 8-times in the inverter and can be assigned independent of each other with different values. Thus it is possible to approach 8 different positions in the positioning module. Since a lot of the parameters in the parameter sets have the same value it would be quite troublesome to adjust each parameter in every set. The following section describes how to copy, lock and select complete parameter sets and how to initialize the inverter again.

6.7.1 Non-programmable Parameters

Certain parameters are non-programmable, since their value must be the same in all sets (e.g. bus address or baud rate). To identify these parameters immediately the parameter set number is missing in the parameter identification. **The same value applies to all non-programmable parameters independent of the selected parameter set.**

6.7.2 Copying of Parameter Sets (Fr.0, Fr.1, Fr.9)



Adjustment of source and target set by keyboard

! By loading the factory setting all definitions defined by the machine builder are reset! This can include the terminal assignment, set changeover or operating conditions. Prior to loading the initialization set or default set make certain that no unintended operating conditions occur.

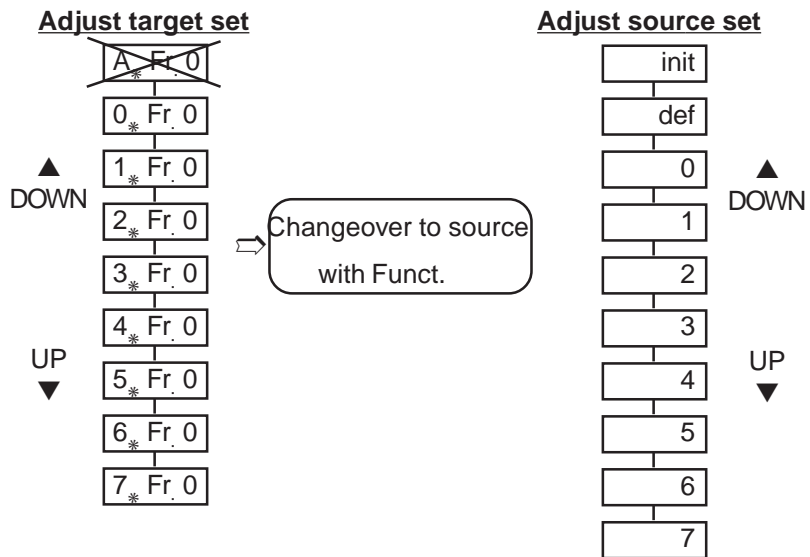

At blinking parameter set number the target set 0...7 is adjusted with the keys UP/DOWN. During copying the active parameter set (A) may not be adjusted as target set. If the target set is > 0, only the programmable sets are overwritten.

With the keys UP/DOWN the initialization set, default set of set 0...7 is adjusted.

- At „init“ all parameters in every set are overwritten with the factory setting.
- At „def“ the target set is overwritten with the factory setting.
- At „0...7“ the selected parameter set is copied into the target set. If the set is > 0, then only the programmable parameters are copied into the target set.

Starting of copying

If the source set is selected, the copying process can be started with „ENTER“. If the copying process is successfully completed the display shows „Pass“, otherwise the message „nco“ (no copy) appears.

Error message „nco“ If error message „nco“ is displayed, it can have the following causes:

Cause	Remedy
Attempt of copying the default set (def) into the just active set.	Open control release or activate another parameter set.
During initialization (init) the control release was not disabled.	Open control release or trigger error.
Source and target set are identical.	Change either source or target set.
The current set (A) is selected as target set.	Select valid value (0...7) as target set.

Adjustment of source and target set by keyboard (Fr.1 / Fr.9)

At bus operation two parameters are responsible for the copying of parameter sets. Fr.9 defines the target set. Fr.1 defines the source parameter set and starts the copying process. These parameters are not visible by way of keyboard.

6.7.3 Selection of Parameter Sets

Fig. 6.8.3.a Principle of parameter set selection

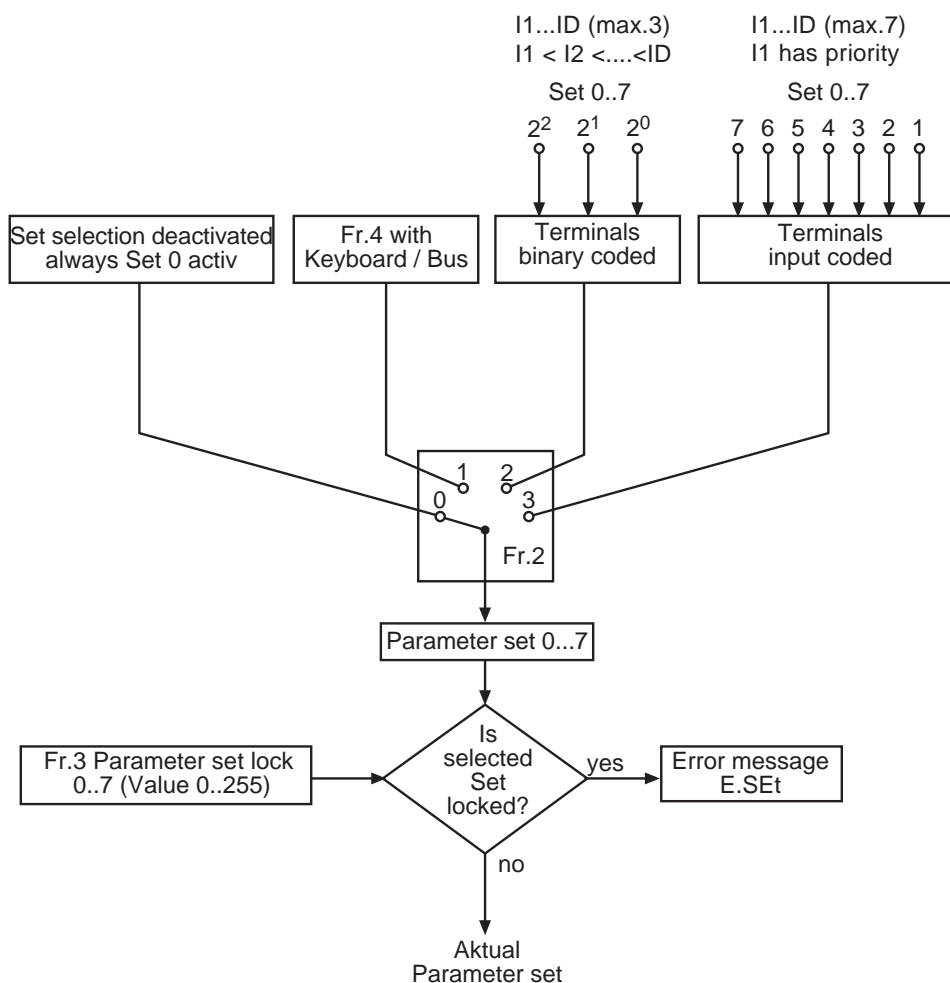

As shown in Fig. 6.8.3 with Fr.2 it is defined whether the parameter set selection is enabled or disabled by keyboard/bus (Fr.4) or by way of terminal strip.

Parameter set source (Fr.2)

Fr.2	Function
0	Set selection disabled; set 0 always active
1	Set selection by keyboard/bus with Fr.4
2	Set selection binary-coded by way of terminal strip
3	Set selection input-coded by way of terminal strip

Parameter set setting (Fr.4)

This parameter can be written by keyboard or by bus. The desired parameter set (0...7) is entered directly as value.

The adjustment by way of terminal strip can be done binary-coded or input-coded. The inputs are defined for set selection with the parameters di.3...di.10 „value 1“.

Binary-coded set selection

For binary-coded set selection

- maximal 3 of the internal or external inputs may be programmed for set selection ($2^3=8$ sets) in order to avoid set selection errors.
- the significance of the inputs programmed for set selection rises ($I1 < I2 < I3 < I4 < I5 < I6 < IA < IB < IC < ID$)

Example 1: Set 0...8 shall be selected with 3 inputs (I1, I3 and I4).

- 1.) Adjust parameter di.3, di.5 and di.6 to value „1“
- 2.) Parameters di.4, di.7...di.10 must be set to $\neq 1$
- 3.) Adjust Fr.2 to value „2“ (set selection binary-coded by way of terminal strip)

Fig. 6.8.3.b Binary-coded parameter set selection

I4	I3	I1	Input
2^2	2^1	2^0	Set
0	0	0	0
0	0	1	1
0	2	0	2
0	2	1	3
4	0	0	4
4	0	1	5
4	2	0	6
4	2	1	7

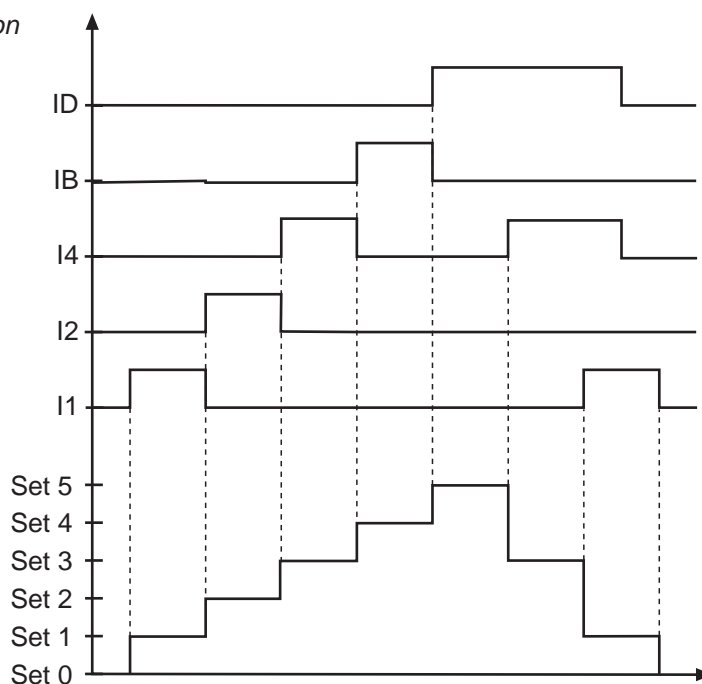

- Input-coded set selection For bit-coded set selection
- maximal 7 of the internal or external inputs may be programmed for set selection (0...7 sets) in order to avoid set selection errors.
 - the lowest of the selected inputs has priority (I1 > I2 > I3 > I4 > I5 > I6 > IA > IB > IC > ID)

Example 1: Set 0...5 shall be selected with 5 inputs (I1, I2, I4, IB und ID).

- 1.) Adjust parameter di.3, di.4, di.6, di.8 and di.10 to value „1“
- 2.) Parameters di.5, di.7 and di.9 must be set to ≠ 1
- 3.) Adjust Fr.2 to value „3“ (set selection input-coded by way of terminal strip)

Fig. 6.8.3.c Input-coded parameter set selection

ID	IB	I4	I2	I1	Set
0	0	0	0	0	0
0	0	0	0	1	1
0	0	0	2	0	2
0	0	3	0	0	3
0	4	0	0	0	4
5	0	0	0	0	5
5	0	3	0	0	3
5	0	3	0	1	1

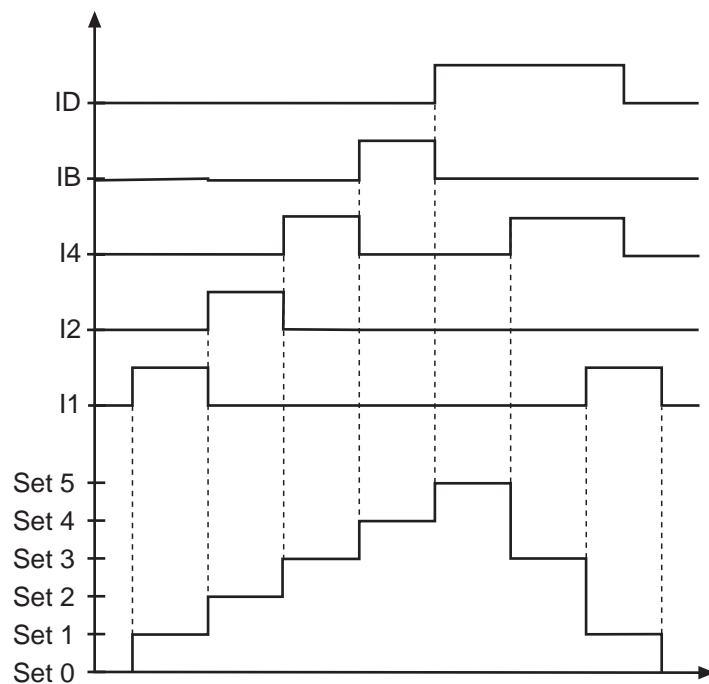

6.7.4 Locking of Parameter Sets

Parameter sets that shall not be selected can be locked with Fr.3. If one of the locked sets is selected, the inverter switches off with set selection error (E.SET).

Parameter set lock (Fr.3)

Value	Locked set	Example
1	0	-
2	1	-
4	2	4
8	3	-
16	4	-
32	5	32
64	6	-
128	7	-
Set 2 and set 5 locked		Sum 36

6.7.5 Parameter Set ON and OFF Delay (Fr.5, Fr.6)

With these parameters a time of 0...10s can be adjusted,

- with which the activation of a new set is delayed (Fr.5)
- with which the deactivation of the old set is delayed (Fr.6)

At set changeover the turn-off time of the old set and the turn-on time of the new set are added up.

Fig. 6.8.5 ON and OFF delay

Example		
Set	Fr.5	Fr.6
0	0 s	0 s
1	2 s	0 s
2	0 s	1 s
3	2 s	2 s

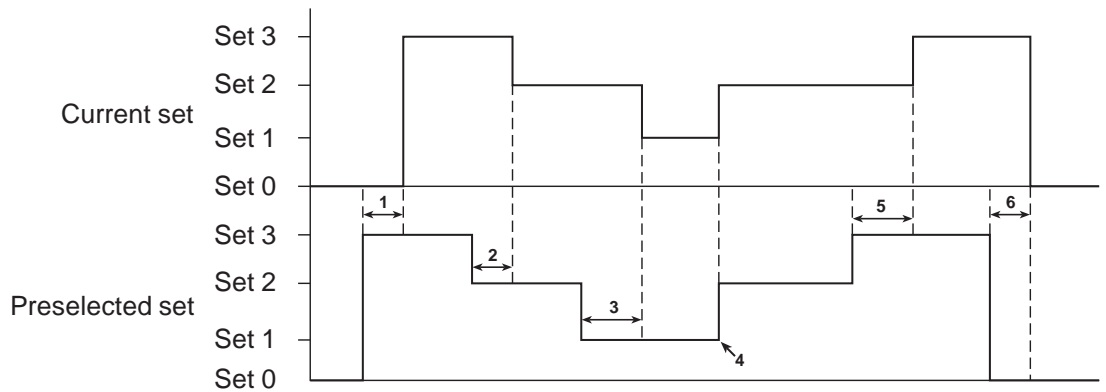

- 1: ON delay set 3 of 2s
- 2: OFF delay set 3 of 2s
- 3: OFF delay set 2 of 1s + ON delay set 1 of 2 s
- 4: Immediate changeover as no delay-time is adjusted
- 5: OFF delay set 2 of 1s + ON delay set 3 of 2s
- 6: OFF delay set 3 of 2s

6.7.6 Used Parameters

Param.	Adr.	R/W	PROG	ENTER	min	max	Step	default	Icon
Fr.0	2700h	✓	✓	✓	-2	7	1	0	not by bus
Fr.1	2701h	✓	-	-	-2	7	1	0	not by keyboard
Fr.2	2702h	✓	-	✓	0	3	1	0	-
Fr.3	2703h	✓	-	✓	0	255	1	0	-
Fr.4	2704h	✓	-	✓	0	7	1	0	-
Fr.5	2705h	✓	✓	-	0,000	10,000 s	0,001 s	0,000	-
Fr.6	2706h	✓	✓	-	0,000	10,000 s	0,001 s	0,000	-
Fr.9	2709h	✓	-	-	-1	7	1	0	not by keyboard

- 1. Introduction
- 2. Summary
- 3. Hardware
- 4. Operation
- 5. Parameter
- 6. Functions**
- 7. Start-up
- 8. Special Operation
- 9. Error Assistance
- 10. Project Planning
- 11. Networks
- 12. Applications
- 13. Annex

- 6.1 Operating and Unit Data
- 6.2 Analog In- and Outputs
- 6.3 Digital In- and Outputs
- 6.4 Set Value and Ramp Adjustment
- 6.5 Motor Data and Controller Adjustment
- 6.6 Keep on Running Functions
- 6.7 Parameter Sets
- 6.8 Special Functions**
- 6.9 Encoder Interface
- 6.10 Synchronous Control
- 6.11 Positioning Module
- 6.12 CP-Parameter Definition

- 6.8.1 Brake Control 3
- 6.8.2 Adjustment Assistant 7
- 6.8.3 AUX-Function 9
- 6.8.4 Motorpotentiometer Function 11
- 6.8.5 Power-Off Function 13
- 6.8.6 Temperature Control 14

6.8 Special Functions

6.8.1 Brake Control

The KEB COMBIVERT F4-F offers the possibility of controlling a holding brake. To activate the brake control an external digital output must be assigned with the function (do.1...do.8 = value „32“). The adaption of the release and delay time to the employed brake is done with LE.67 and LE.68. To prevent the engagement of the brake in case of fast successive positionings a delay time (LE.66) can be adjusted. So as to avoid that oscillations of the drive during standstill prevent the activation of the brake a speed hysteresis (LE.37) can be adjusted.

Basic settings	For the activation of the brake control following basic settings should be made:
	<ol style="list-style-type: none"> 1. Assign the function „Brake control“ (value „32“) to the digital output.
Application time (LE.68)	<ol style="list-style-type: none"> 2. Adjust the application time LE.68 according to the data sheet of the brake. The application time defines the time from the triggering of the brake until the safe load transfer. This means for the inverter that the modulation is switched off only after the expiration of the application time. Setting range: 0...5000 ms, default 0ms.
Release time (LE.67)	<ol style="list-style-type: none"> 3. Adjust release time with LE.67 according to the data sheet of the brake. The release time defines the time from triggering the brake until the complete release and can be adjusted in the range of 0...5000ms (default 0ms). This means for the inverter <ul style="list-style-type: none"> - after setpoint setting the modulation is enabled but the setpoint value is still maintained on 0 min⁻¹ - the brake is released, the drive takes over the load - if no error occurs the setpoint is enabled after expiration of the release time.
Speed hysteresis (LE.37)	<ol style="list-style-type: none"> 4. The speed hysteresis is active during the delay time (see next page). If the hysteresis is exceeded during the delay time the delay time starts again. The speed hysteresis can be adjusted in a range of 0...9999,5 min⁻¹ (default 10 min⁻¹).
Delay time (LE.66)	<p>The delay time prevents the unnecessary engagement of the brake, e.g. in case of fast successive positioning commands.</p> <p>If all other conditions for the engagement of the brake are met, the delay time starts. During this time the drive can restart immediately with a new setpoint value or drive command. After expiration of the delay time the brake engages irrevocably. A new setpoint value or drive command can now only be given after expiration of the application and release time. The delay time is adjustable in the range of 0...65535ms (default 0ms).</p>

Examples of brake control **Deactivation of modulation**

If the modulation is switched off (e.g. through control release or error), the brake engages immediately without a delay time.

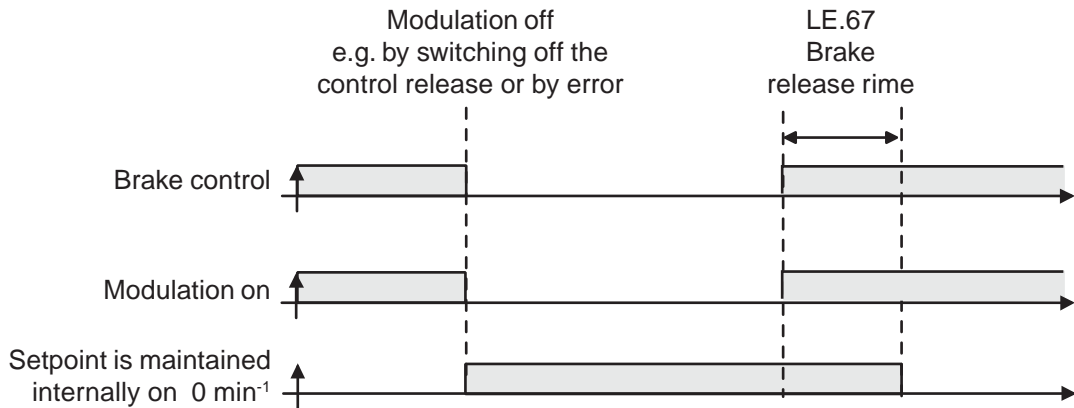

Speed controlled operation

In case of missing rotation setting (status 'LOW SPEED') and a actual speed value smaller than the speed hysteresis LE.37, the delay time of the brake expires. (Attention: For the speed hysteresis a value of $\geq 15 \text{ min}^{-1}$ should be adjusted, since otherwise the brake never engages at the smallest speed fluctuations). After expiration of the delay time the brake application time starts, only after that the modulation is disabled.

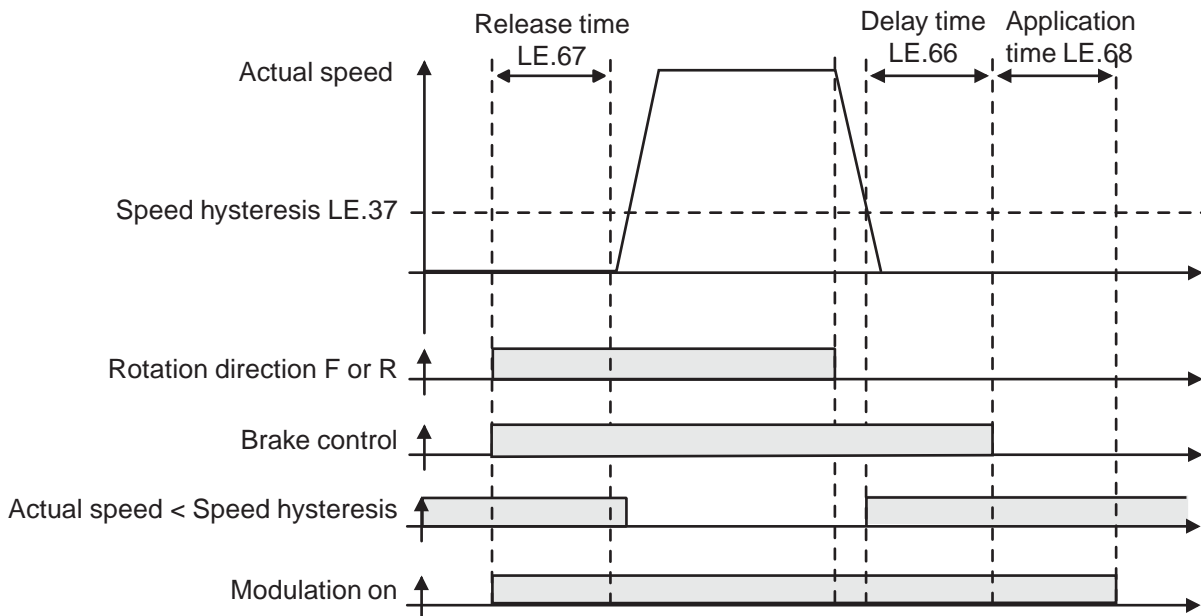

Positioning without 'Target window reached' signal (i.e. no switching condition programmed on value 30: 'Target window reached') :

The same function as before but in addition to the condition actual speed smaller speed hysteresis the status 'rFP:positioning can be started' must be achieved. In this mode the speed setting has no function.

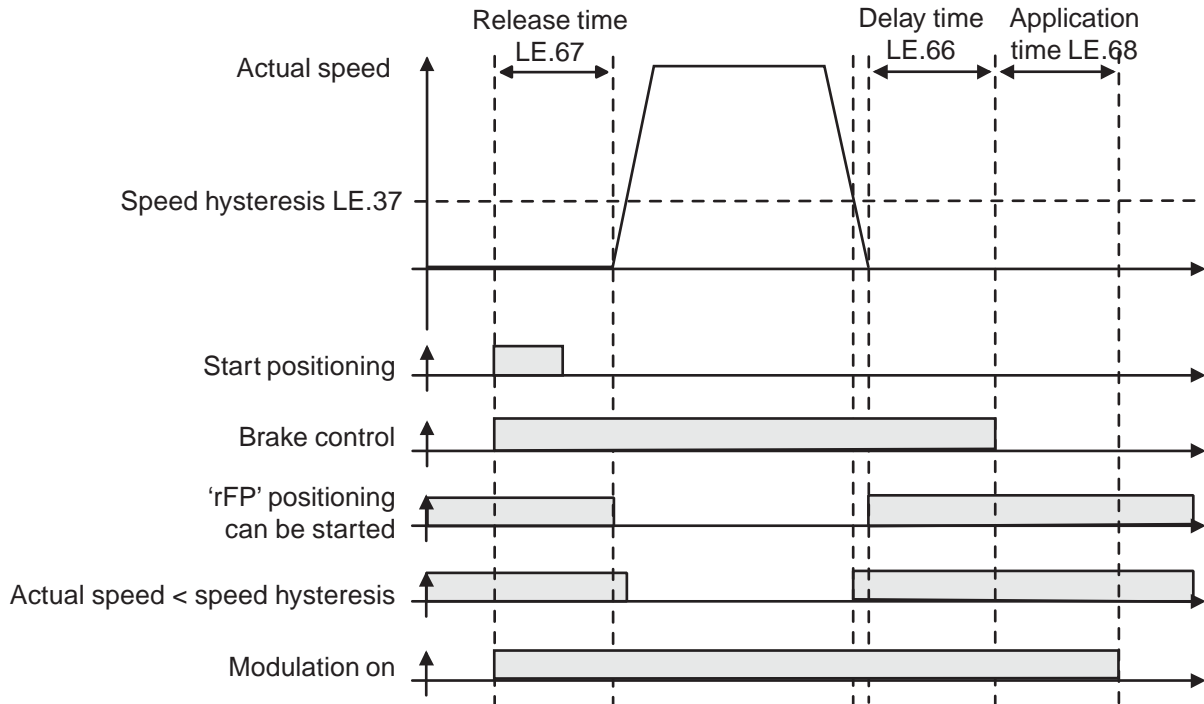





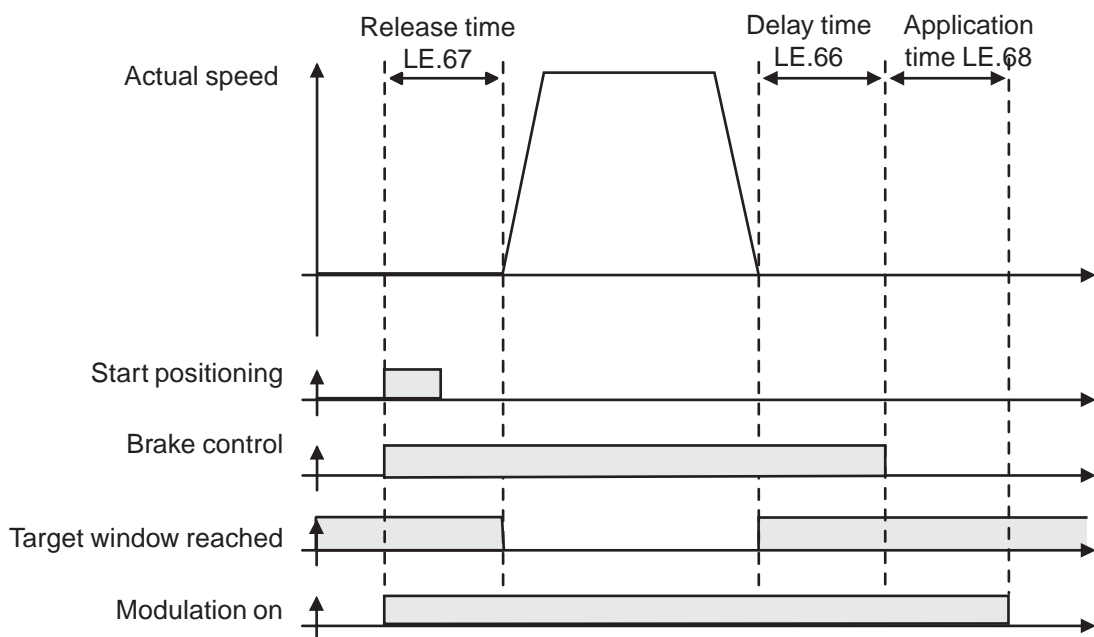



Brake handling at activated positioning with 'Target window reached'-signal:

With the signal 'Target window reached' the brake delay time starts. the speed hysteresis has no function in this mode.



Used Parameters

Param.	Adr.	R/W 	PROG. 	ENTER 					
LE.37	2B25h	✓	-	-	0 min ⁻¹	9999,5 min ⁻¹	0,5 min ⁻¹	10 min ⁻¹	-
LE.66	2B42h	✓	-	-	0 ms	65535 ms	1 ms	0 ms	-
LE.67	2B43h	✓	-	-	0 ms	5000 ms	1 ms	0 ms	-
LE.68	2B44h	✓	-	-	0 ms	5000 ms	1 ms	0 ms	-

6.8.2 Adjustment Assistant

In combination with the program „Inverter Scope“ the following parameters give assistance with regard to the adjustment of the inverter. The program functions like a 4-channel oscilloscope.

The four channels are adjusted to any parameter address by way of AA.0...AA.3, which are given out over AA.10...AA.13. With AA.4...AA.9 the time basis as well as the trigger point are defined.

At the parameters AA.10...AA.13 the adjusted values for channel 1...4 are given out. A direct access to these parameters is not necessary since the „Inverter Scope“ is equipped with its own operator surface and has program-internal access to the AA-parameters. The handling of the „Inverter Scope“ is explained in the COMBIVIS Instruction Manual.

AA.0	Graph 1 parameter selection							3200h	
AA.1	Graph 2 parameter selection							3201h	
AA.2	Graph 3 parameter selection							3202h	
AA.3	Graph 4 parameter selection							3203h	
Adr.									
s.a.	<input checked="" type="checkbox"/>	<input type="checkbox"/>	<input type="checkbox"/>	0	65535	1	-	0

These parameters contain the addresses of the parameters which shall be recorded by the „inverter scope“.

AA.4	Time base								
Adr.									
3204h	<input checked="" type="checkbox"/>	<input type="checkbox"/>	<input type="checkbox"/>	0,001	32,000	0,001	-	0,001

This parameter contains the time basis for the recording of the parameter values.

AA.5	Trigger source								
Adr.									
3205h	<input checked="" type="checkbox"/>	<input type="checkbox"/>	<input type="checkbox"/>	0	255	1	-	255

AA.6	Trigger position								
Adr.									
3206h	<input checked="" type="checkbox"/>	<input type="checkbox"/>	<input type="checkbox"/>	0	variable	1	-	10

AA.7 Synchronisation									
Adr.									
3207h	<input checked="" type="checkbox"/>	<input type="checkbox"/>	<input type="checkbox"/>	-32767	32767	1	-	0
This parameter serves to synchronize the PC-program with the inverter.									

AA.8 Trigger status									
Adr.									
3208h	<input type="checkbox"/>	<input type="checkbox"/>	<input type="checkbox"/>	0	2	1	-	0
This parameter serves to synchronize the PC-program with the inverter.									

AA.9 Sélect graph address									
Adr.									
3209h	<input checked="" type="checkbox"/>	<input type="checkbox"/>	<input type="checkbox"/>	0	variable	1	-	0
This parameter serves for the readout of the values recorded in the unit.									

AA.10	Read graph 1	320Ah							
AA.11	Read graph 2	320Bh							
AA.12	Read graph 3	320Ch							
AA.13	Read graph 4	320Dh							
Adr.									
s.a.	<input type="checkbox"/>	<input type="checkbox"/>	<input type="checkbox"/>	0	-	1	-	-
These parameters serve for the readout of the values recorded in the unit.									

6.8.3 AUX-Function (An.13)

The AUX-function offers the possibility to affect the setpoint value, speed controller or torque limitation by way of the analog input REF2. In a special mode a torque control can be realized. Parameter An.13 defines the function of the AUX-function.

An.13	AUX-Function
0	no function
1	The AUX-signal is added to the actual setpoint signal (analog or digital). Setpoint = setpoint signal + AUX-signal (-10 V ... +10 V)
2	The AUX-signal acts a multiplier for parameter CS.0 (KP-speed) AUX 0...10 V \triangleq gain 0...1
3	The AUX-signal acts as multiplier for parameter CS.1 (KI-speed) AUX 0...10 V \triangleq gain 0...1
4	The AUX-signal acts as multiplier for CS.0 and CS.1 (total gain); AUX 0...10 V \triangleq gain 0...1
5	The AUX-signal acts as multiplier for parameter CS.6 and CS.7 (torque limitation); AUX 0...10 V \triangleq gain 0...1
6	Torque control (see Chapter 6.5.18 „Torque Control“)
7	Gear factor pos. AUX 0...10 V \triangleq 0...20 + Sn.2..Sn.3
8	Gear factor neg. AUX 0...10 V \triangleq 0...-20 + Sn.2..Sn.3
9	max. positioning speed AUX 0...10 V \triangleq 0...1 Pd.7

6.8.4 Motor-potentiometer Function

This function simulates a mechanical motor potentiometer. By way of two programmable inputs the value of the motor potentiometer can be increased or decreased.

Fig. 6.8.4 Motorpotentiometer function

SP.26 Motorpoti / Function				
8	4	2	1	Meaning
x	x	x	0	set programmble
x	x	x	1	non-set programmble
x	x	0	x	no motor potentiometer reset
x	x	1	x	reset after Power on
0	0	x	x	0...100 % in 16 s
0	1	x	x	0...100 % in 33 s
1	0	x	x	0...100 % in 66 s
1	1	x	x	0...100 % accord. to SP.29

SP.27 0,00...300,00 s
Motorpoti time

Increase of motorpoti value
assign value „13“ to prog.
input di.3...12

Decrease motorpoti value
assign value „14“ to prog.
input di.3...12

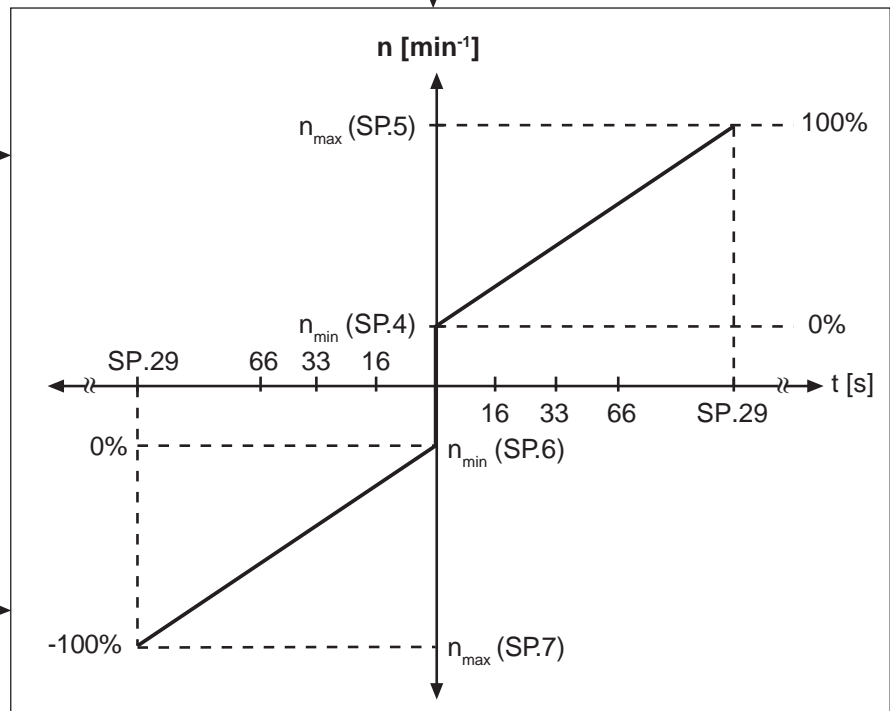

Rotation
+ = forward
- = reverse

Setpoint

Speed setting

Setpoint setting

Input definition The first step is the definition of two inputs with which the motor potentiometer can be increased and decreased. Depending on the selected inputs two of the parameters di.3...di.12 are assigned with the value 14 and 15.

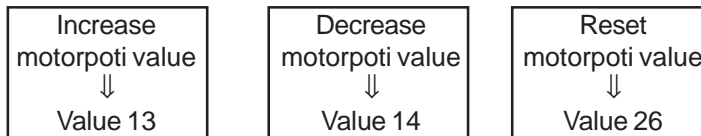

The potentiometer value is decreased, if the inputs potentiometer value are triggered at the same time.

Motor potentiometer/Function (SP.26) With SP.26 some basic operational modes of the motor potentiometer are defined. The parameter is bit-oriented.

Value	Meaning
8 4 2 1	
x x x 0	Motor potentiometer can be programmed differently in all parameter sets.
x x x 1	Motor potentiometer is not set-programmable
x x 0 x	After a power-on reset the last potentiometer value is adjusted.
x x 1 x	After a power-on reset the potentiometer value is set to 0 %.
0 0 x x	Rise time of 0...100% of motor potentiometer 16 s
0 1 x x	Rise time of 0...100% of motor potentiometer 33 s
1 0 x x	Rise time of 0...100% of motor potentiometer 66 s
1 1 x x	Rise time of 0...100% depending on parameter SP.27
0 0 0 0	= 0 (Default value)

Motor potentiometer/Rise time (SP.27) With this parameter a time is defined which the motor potentiometer needs to drive from 0...100%. The adjusted time takes effect when a value of ≥ 12 is adjusted in parameter SP.26. The time is adjustable in a range of 0,00...300,00 s (Factory setting 128s).(From software version 1.3)

Correcting range (SP.4...SP.7) The absolute setpoint limits of the motor potentiometer (-100%...0...+100%) are limited by the minimum/maximum frequencies (SP.4 and 5 or SP.6 and 7) (see Fig. 6.8.4).

Setpoint and rotation direction (SP.0) To set the setpoint value by way of the motor potentiometer parameter SP.0 (setpoint source) must be adjusted accordingly.

Rotation	SP.0	Setpoint
Keyboard/Bus	15	Motorpoti
Terminal strip	16	Motorpoti
\pm Motorpoti	17	Motorpoti

6.8.5 Temperature Control

This function serves as temperature control for water-cooled inverters. The cooling system can be controlled by a solenoid valve. Dependent on the used valve, the control circuit must be made available by the customer. The control is activated via the transistor output (do.1...do.8 value „34“ see „digital outputs“ chapter 6.3.10) of the KEB COMBIVERT. **Attention! Don't use relay output!**

Temperature switching time (LE.70) The temperature switching time defines the cycle time for the output. This time can be adjusted in a range of 1,0...100,0 s (standard 10 s).

Set temperature (LE.71) The heat sink temperature is preset with LE.71. This temperature can be adjusted in a range of 20 °C...OH-temperature (see power circuit data) (standard 40 °C).

Max. temperature (LE.72) The output is generally set, if the heat sink temperature exceeded the max. temperature adjusted in LE.72. LE.72 can be adjusted in a range of 20°C...OH-temperature (see power circuit data) (standard 50 °C).

Minimum temperature (LE.73) The output is generally switched off, if the heat sink temperature is below the min. temperature adjusted in LE.73. LE.73 can be adjusted in a range of 20°C...OH-temperature (see power circuit data) (standard 30 °C).







If the heat sink temperature is inside the adjusted temperature limits of LE.72...LE.73, the connecting time T_{on} of the output is calculated with the following formula.

$$T_{on} = \frac{(\text{Max.temp.}-\text{set temp.})+(\text{heat sink temp.}-\text{set temp.})}{\text{Max. temp.}-\text{min. temp.}} \cdot \text{temperature switching time}$$

Coolant warning (LE.74) A digital output can be set (do.1...do.8 = „35“), if the heat sink temperature exceeds the max. temperature (LE.72) with the adjusted prewarning time. The prewarning time is calculated as follows:

$$\text{Prewarning time} = \text{temperature switching time (LE.70)} \cdot \text{coolant warning (LE.74)}$$

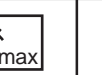
Used Parameters

Param.	Adr.	 R/W	 PROG.	 ENTER					
LE.70	2B46h	✓	-	-	1,0 s	100,0 s	0,1 s	10,0 s	-
LE.71	2B47h	✓	-	-	20 °C	OH-Temp.	1 °C	40 °C	OH-Temp see power circuit
LE.72	2B48h	✓	-	-	20 °C	OH-Temp.	1 °C	50 °C	OH-Temp see power circuit
LE.73	2B49h	✓	-	-	20 °C	OH-Temp.	1 °C	30 °C	OH-Temp see power circuit
LE.74	2B50h	✓	-	-	1	50	1	5	-

- 1. Introduction
- 2. Summary
- 3. Hardware
- 4. Operation
- 5. Parameter
- 6. Functions
- 7. Start-up
- 8. Special Operation
- 9. Error Assistance
- 10. Project Planning
- 11. Networks
- 12. Applications
- 13. Annex

- 6.1 Operating and Unit Data
- 6.2 Analog In- and Outputs
- 6.3 Digital In- and Outputs
- 6.4 Set Value and Ramp Adjustment
- 6.5 Motor Data and Controller Adjustment
- 6.6 Keep on Running Functions
- 6.7 Parameter Sets
- 6.8 Special Functions
- 6.9 Encoder Interface
- 6.10 Synchronous Control
- 6.11 Positioning Module
- 6.12 CP-Parameter Definition

- 6.9.1 Designs 3
- 6.9.2 Encoder Interface Channel 1
Incremental encoder 4
- 6.9.3 Encoder Interface Channel 1
Resolver 6
- 6.9.4 Encoder Interface Channel 1
Hiperface 6
- 6.9.5 Encoder Interface Channel 2 ... 8
- 6.9.6 Selection of Encoder 10
- 6.9.7 Basic Settings 12
- 6.9.8 Power Supply of Encoder 13
- 6.9.9 Used Parameters 14

6.9 Encoder Interface The KEB COMBIVERT F4-F supports two from each other separated encoder channels.

6.9.1 Designs

Channel 1 (X4)

- is an incremental encoder input for sine-wave 1Vss- or rectangular signals

Channel 2 (X5)

- is an incremental encoder input and/or output for rectangular singals

Decision of the encoder interfaces (EC.00, EC.10)

There are different encoder interfaces for the various encoder types. EC.00 and/ or EC.10 indicated the installes inteface.

EC.00	Encoder interface 1 / X4
0	Incremental encoder
3	Resolver
10	HTL incremental input
11	Hiperface

EC.10	Encoder interface 2 / X5
0	Incremental encoder
1	SSI absolute encoder
4	Incremental output
7	Inc I/O
12	Inc.-input / replica

Fig. 6.9.1 Encoder survey

up to housing size E

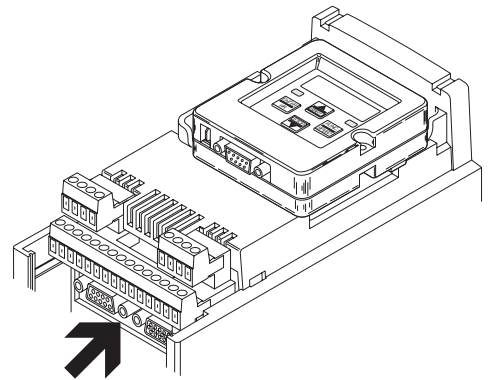
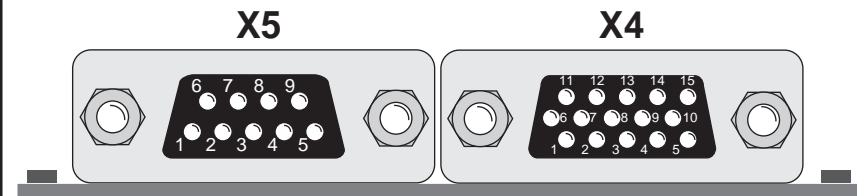

from housing size G upwards

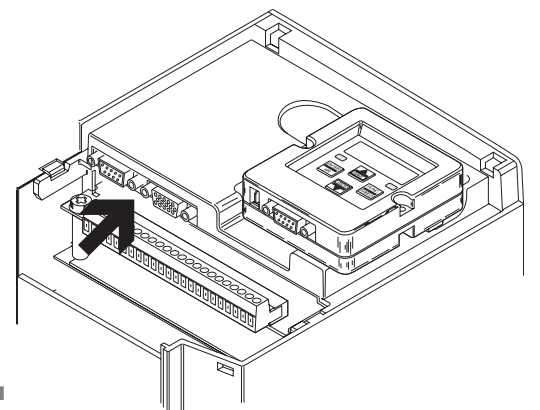
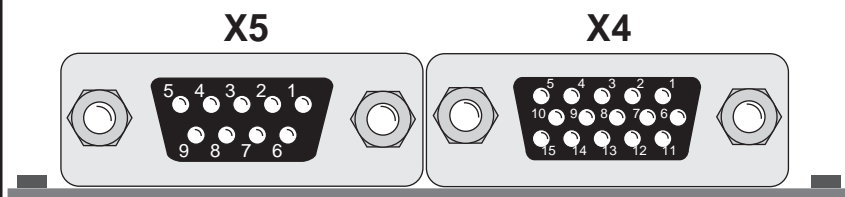

6.9.2 Encoder Interface Channel 1 (X4) Incremental encoder

The encoder interface 1 is the connection for the speed feedback of the KEB COMBIVERT F4-F, which is imperative for the entire control (current control, too).

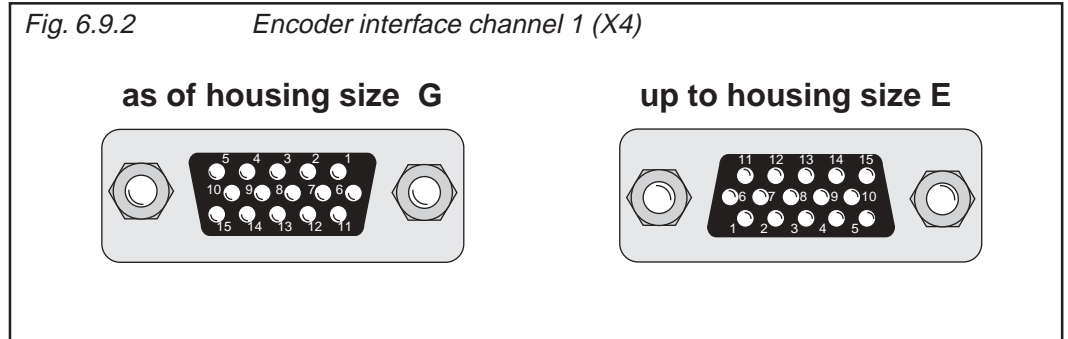

Pin description

Signal	X4	Description
U_{var}	11	Supply voltage for encoder
+5 V	12	Supply voltage for encoder
0 V	13	Reference potential
A	8	Signal input A
\bar{A}	3	Signal input A inverted
B	9	Signal input B
\bar{B}	4	Signal input B inverted
N	15	Reference marking input N
\bar{N}	14	Reference marking input N inverted
Shield	Housing	Shielding

! Only when the inverter is switched off and the voltage supply is disconnected may the plug be pulled out or plugged in !

U_{var} U_{var} is an unstabilized voltage that is provided by the power stage of the KEB COMBIVERT. Dependent on the size of unit and the load, the voltage amounted to 15... 30 V DC (see chapter 6.9.6). U_{var} is loadable at X4 and X5 with altogether 110 mA. If higher voltages / currents to supply the encoders are needed then the control must be supplied with an external voltage.

+5V The +5 V voltage is a stabilized voltage and loadable at X4 and X5 with altogether 300 mA.

Inputs The signal and reference marking inputs can be triggered with rectangular pulses as well as sine-wave signals. The signal inputs must generally be connected. The reference marking signals are only needed for the reference point approach in the positioning operation. Following specifications apply to the encoder interface 1 (X4):

- max. operating frequency of input $f_G = 200$ kHz
- internal terminating resistor $R_t = 150 \Omega$
- 2...5 V high level at rectangular signals
- $U_0 = 2,5$ V , at sine / cosine signals 1 Vss

Concerning encoder inputs with HTL-level please contact KEB.

**Adjustment of encoder line number
(EC.01, EC.11)**

With this parameter the encoder line number is adjusted to the connected encoder within a range of 256...10000.

- EC.01 for encoder interface 1
- EC.11 for encoder interface 2

Input only possible at „modulation off“.

**Encoder track change
(EC.02, EC.12)**

If you find that during start-up in controlled operation the actual and setpoint speed have different signs it can be an indication for a wrong connection of the incremental encoder. If possible the wiring should be corrected. Should this involve too much effort then you can achieve a rotation reversal of encoder 1 by means of EC.02 / EC.12. The effect corresponds to a change of the A and B tracks of the incremental encoder.

- EC.02 for encoder interface 1
- EC.12 for encoder interface 2

Input only possible at „modulation off“.

**Encoder resolution
(EC.06)**

When connecting sine / cosine encoders the accuracy of the position recording is improved by activating the high-resolution (EC.06 = 1). For incremental encoders with rectangular signals the adjustment must be EC.06 = 0.

6.9.3 Encoder interface 1 (X4) Resolver

Pin description

Signals	X4	Description
SIN_LO	3	SIN-input
SIN	8	SIN-input
SIN_REF_LO	5	Reference signal input
SIN_REF	10	Reference signal input
COS_LO	4	COS-input
COS	9	COS-input
Shield	Housing	Shield

! Only when the inverter is switched off and the voltage supply is disconnected may the plug be pulled out or plugged in !

Line number encoder 1 (EC.05)

With EC.05 the exciter frequency for a resolver can be preset. Input only possible at „modulation off“.

Current input Resolver (EC.09)

This parameter is used only for the adjustment of the threshold of the current input of the resolver for E.ENC. If one writes the value -1 : Auto the current input is measured and the parameter optimally adjusted.

6.9.4 Encoder interface 1 (X4) Hiperface

Pin description

Signals	X4	Description
0 V	13	Reference potential
COS +	8	Signal input A
REF_COS	3	Signal input A
SIN +	9	Signal input B
REF_SIN	4	Signal input B
DATA +	15	Data channel
DATA -	14	Data channel
12 V	10	Supply voltage for encoder (150 mA)
Shield	Housing	Shield

! Only when the inverter is switched off and the voltage supply is disconnected may the plug be pulled out or plugged in !

Hiperface (EC.20)

The parameter EC.20 shows the type of the hiperface-encoder (Stegmann) at encoder 1.

EC.20	Encoder 1
02h	SCS 60/70
07h	SCM 60/70
22h	SRS 50/60 SCS-KIT 101
27h	SRS 50/60 SCS-KIT 101

Hiper-Status (EC.21) The current encoder status is indicated here.

Error type	Status code	Description	SINCOS SCS/SCM/KIT	SINCOS SRS/SRM	E:ENC
Initialisation	00h	OK	X	X	
	01h	Analog signals outside the specification		X	
	02h	Internal angular offset faulty		X	
	03h	Table about data portion destroyed	X	X	
	04h	Analog limit values not available		X	
	05h	Internal I ² C-Bus not functioning	X	X	
	06h	Internal check-sum error	X	X	
Protocol	07h	Encoder reset occured through program monitoring		X	
	09h	Parity error	X	X	
	0Ah	Check-sum of transmitted data wrong	X	X	
	0Bh	Unknown command code	X	X	
	0Ch	Number of transmitted data wrong	X	X	
	0Dh	Transmitting command argument is incorrect	X	X	
Data	0Eh	The selected data filed may be not written on	X	X	
	0Fh	Access code wrong	X	X	
	10h	Specified data field not changeable in its size		X	
	11h	Specified word address outside the data field	X	X	
	12h	Access to non-existing data field	X	X	
Position	01h	Analog signals outside the specification		X	
	1Fh	Speed too high, no position formation possible		X	
	20h	Position single-turn inadmissible		X	
	21h	Position error multi-turn		X	
	22h	Position error multi-turn		X	
	23h	Position error multi-turn		X	
others	1Ch	Amount monitoring of analog signals (process data)			
	1Dh	Transmit current critical		X	
	1Eh	Encoder temperature critical		X	
	08h	Overflow of conter		X	
KEB internal	41h	Type identification + serial identification undefined	X	X	X
	42h	KEB identifier bytes undefined	X	X	X
	43h	Hiperface busy (after time out time E.EnC)	X	X	X
	4Ah	Raed data	X	X	
	4Bh	Save data	X	X	
	60h	unknown service	X	X	X
	FFh	collective error, no communication	X	X	X
	80h	Position error (deviation of the absolute position from the counted increments)	X	X	X
	Fdh	Check-sum error	X	X	X
	FEh	Parity error	X	X	X

6.9.5 Encoder Interface Channel 2 (X5)

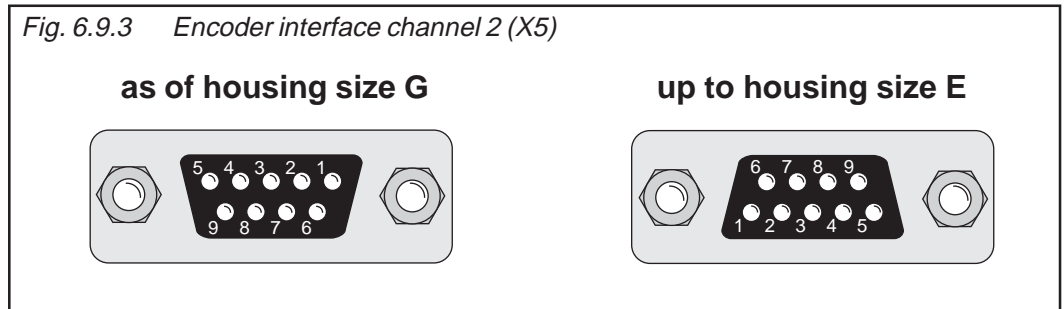

Operating mode encoder 2 (EC.13)

With parameter EC.13 it is defined whether the encoder channel 2 shall work as input or output. Precondition for that is a built-in switch-selectable encoder interface.

EC.13	Function
0	Incremental encoder output
1	Incremental encoder input

Incremental encoder input

In synchronous operation the second incremental encoder serves as input of the slave drive. A second position encoder can be connected for positioning operation.

Signal	X5	Description
U_{var}	5	Supply voltage for encoder (see 6.9.2)
+5 V	4	Supply voltage for encoder (see 6.9.2)
0 V	9	Reference potential
A	1	Signal input A
\bar{A}	6	Signal input A inverted
B	2	Signal input B
\bar{B}	7	Signal input B inverted
N	3	Reference marking input N
\bar{N}	8	Reference marking input N inverted
Shield	Housing	Shielding

! Only when the inverter is switched off and the voltage supply is disconnected may the plug be pulled out or plugged in !

The signal inputs of the second encoder interface support **only rectangular signals**.

Following specifications apply to the encoder interface 2 (X5):

- max. operating frequency of input $f_G = 300$ kHz
- internal terminating resistor $R_T = 150 \Omega$
- 2...5 V high level at rectangular signals

Incremental encoder output (Ec.13 = 2)

The incremental encoder output gives out the signals recorded at the encoder interface 1:1 in RS422-specification over the second channel (e.g. master drive in synchronous operation).

Signal	X5	Description
U_{var}	5	Supply voltage for encoder (see 6.9.2)
+5 V	4	Supply voltage for encoder (see 6.9.2)
0 V	9	Reference potential
A	1	Signal output A
\bar{A}	6	Signal output A inverted
B	2	Signal output B
\bar{B}	7	Signal output B inverted
N	3	Reference marking output N
\bar{N}	8	Reference marking output N inverted
Shield	Housing	Shielding

SSI-Interface for absolute value encoder (Optional to X5)

Clock frequency : 312,5 kHz or 156,25 kHz
 Signals : RS 422 / Clock and data
 Max. transmission link : 50 m
 Released encoder types : Heidenhain ROC 424, Stegmann AG 626 or compatible.

PIN No.	Signal
1	Clock +
2	Data +
3	n.c.
4	+ 5 V
5	+18 V
6	Clock -
7	Data -
8	n.c.
9	GND

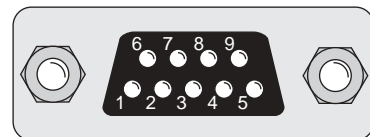

! Only when the inverter is switched off and the voltage supply is disconnected may the plug be pulled out or plugged in !

Encoder 2 code (EC.16)

For SSI-encoder two codes are supported by the unit:

0 : Binary coded

1 : Gray code

Input only possible at „modulation off“.

Multiturn resolution encoder 2 (EC.14)

When a SSI-multiturn-absolute value encoder is connected, the bits for the multiturn-resolution can be adjusted. (12 bit)

Input only possible at „modulation off“.

Encoder 2 clock frequency (EC.15)

The clock frequency of the SSI-encoder is adjusted with parameter EC.15. Selection between two clock frequencies is possible 0 : 312,5 kHz or 1 : 156,25 kHz. The smaller clock frequency should only be adjusted with long line lengths, because malfunctions can occur with a bigger clock frequency.

Input only possible at „modulation off“.

6.9.6 Selection of Encoder

Precondition for a good control behaviour of a drive is not least a question of the selection and the correct connection of the encoder. This also includes the mechanical as well as the electrical connection.

Max. operating frequency (max. sampling frequency)

Depending on the max. operating frequency of the encoder input, the encoder and the maximum speed of the drive the line number of the encoder can be selected.

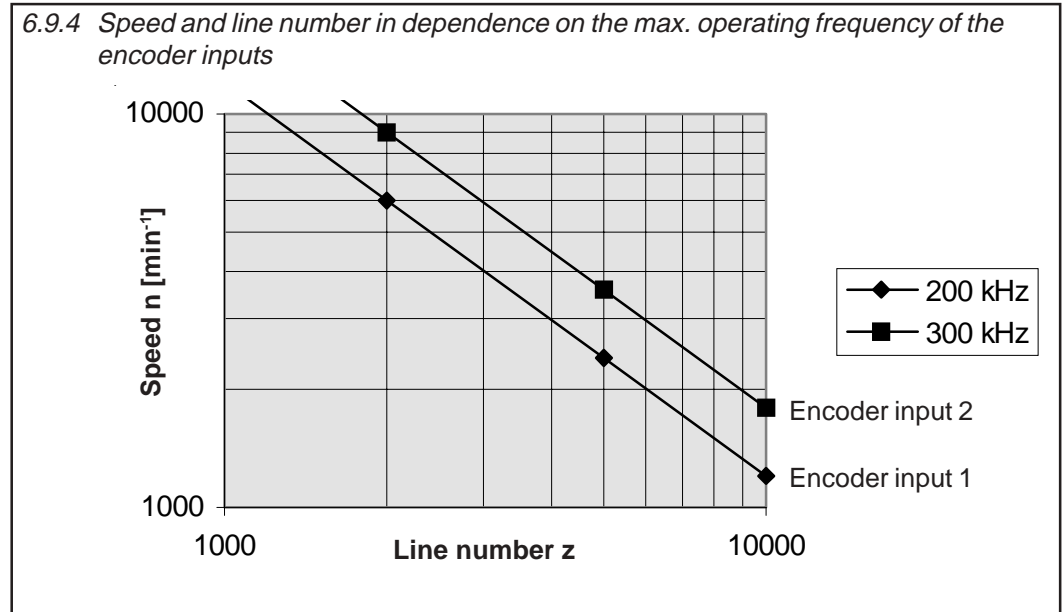

The max. signal frequency, which is given out by the encoder, is calculated as follows:

$$f_{\max} [\text{kHz}] = \frac{n_{\max} [\text{min}^{-1}] \times z}{60000}$$

f_{\max} : max. signal frequency
 n_{\max} : max. speed
 z : encoder line number

The following condition must be met:

$$f_{\max} < \text{max. operating frequency of encoder} < \text{max. operating frequency of interface}$$

Input signals The encoder interfaces support following input signals:

Encoder interface 1 (X4)	Encoder interface 2 (X5)
Rectangular signal with 2...5 V sine-wave signal with 1 V _{ss}	Rectangular signal with 2...5 V

6.9.4.a Input signals

TTL-voltage differential levels according to TIA/EIA-RS422-B

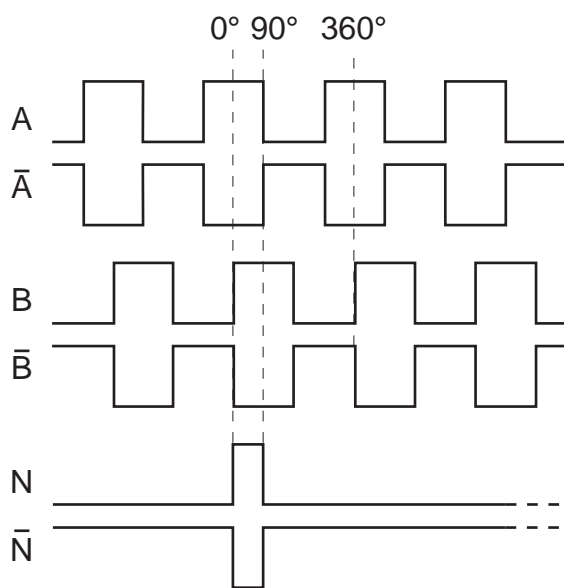

Sine-wave signal $U_{ss}=1\text{ V}$; $U_0=2,5\text{ V}$; (only for X4)

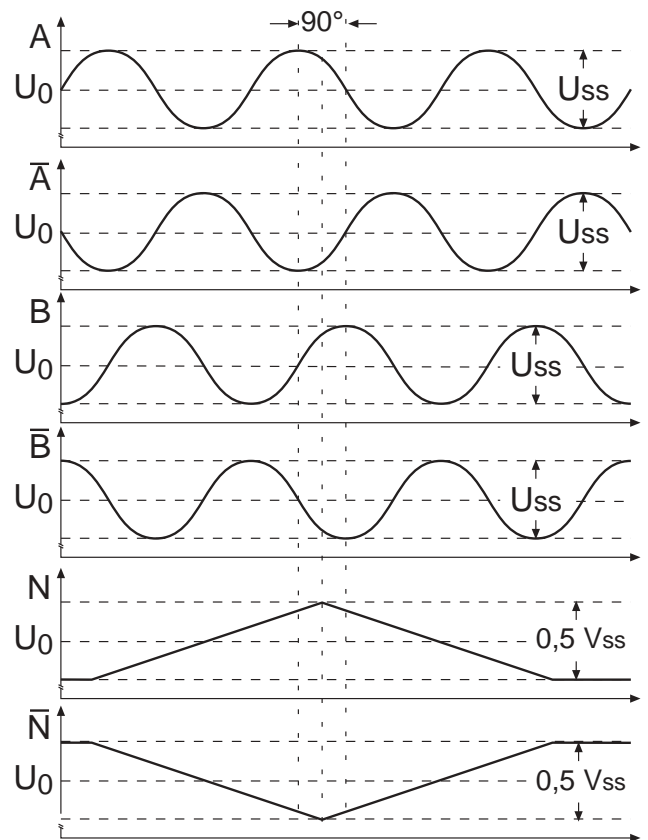

The two, by 90° electrical out of phase signals, A and B as well as their inverted signals are generally evaluated. The zero track is needed for the reference point approach in the positioning module. Zero track (also reference marking channel) gives out 1 signal per revolution.

Cable length To achieve an unobjectionable function following cable lengths should not be exceeded. Precondition for it is that the supply voltage at the rotary encoder is within the specified tolerances.

The encoder lines should not be longer than 50 m. If longer cables are needed, please contact KEB.

Further information can be taken from the documentation of the respective manufacturer.

6.9.7 Basic Setting

Prior to start-up the inverter must be adapted to the encoder(s) which is/are used.

**Speed sampling time
(EC.08, Ec.18)**

This parameter defines the time over which the speed average is determined. At that the resolution of the speed detection is defined simultaneously.

dr.40	Sampling time	Speed resolution with the use of an incremental encoder with 2500 pulses
0	0,5 ms	12 min ⁻¹
1	1 ms	6 min ⁻¹
2	2 ms	3 min ⁻¹
3	4 ms	1,5 min ⁻¹ (factory setting)
4	8 ms	0,75 min ⁻¹
5	16 ms	0,375 min ⁻¹

When using other line numbers:

$$\text{Speed resolution} = \frac{\text{Specified speed resolution} \times 2500}{\text{Line number}}$$

- EC.08 for encoder interface 1
- EC.18 for encoder interface 2

Input only possible at „modulation off“.

6.9.8 Power Supply of Encoder

Generally applicable statement with regard to the power supply:

The internal 15V or 18V power supply at X4 and X5 can be loaded altogether with max. 110mA. If higher currents are required; an external voltage can be used. The 5V-power supply is loadable with altogether 300mA

Fig. 6.9.6 Power supply

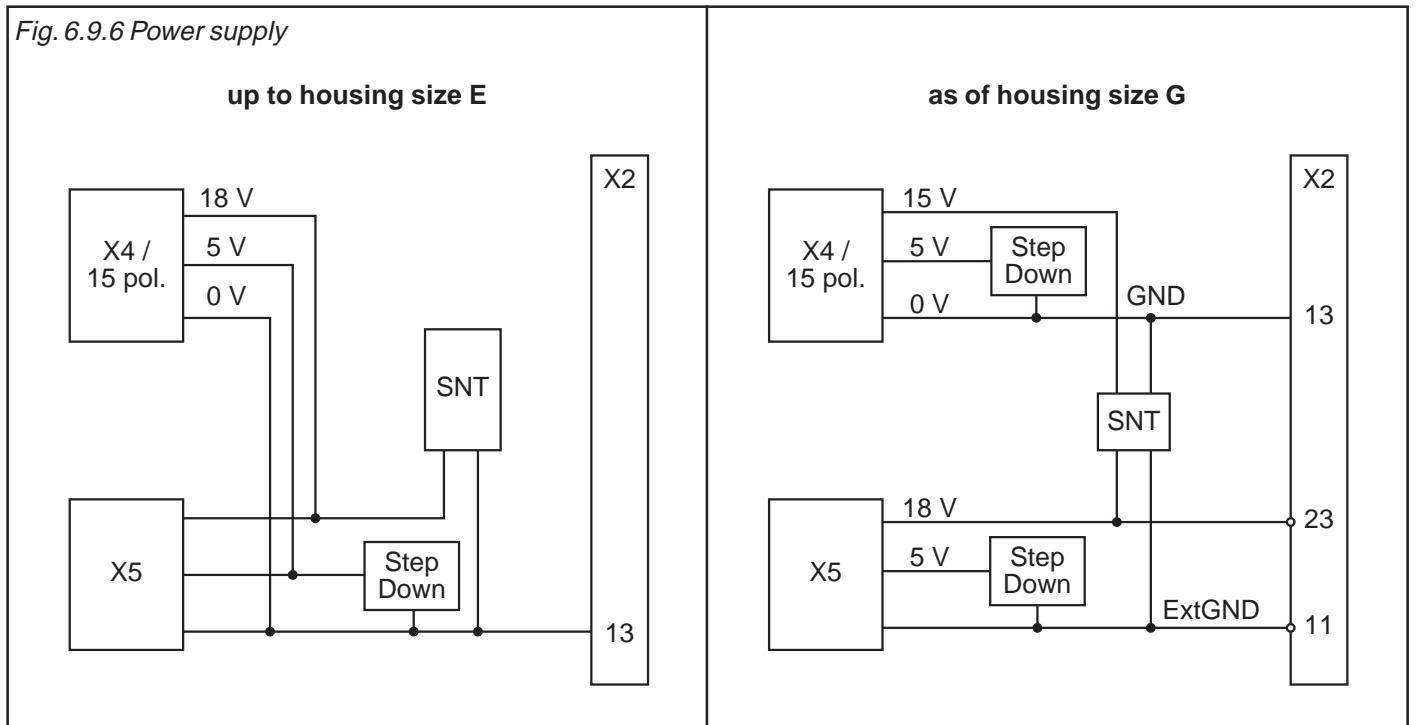

6.9.9 Used Parameters

Param.	Adr.	R/W	PROG.	ENTER	min	max	Step	default	
EC.00	3800h	✓	-	-	-	-	-	-	-
EC.01	3801h	-	-	-	256 Inc.	10000 Inc.	1	2500 Inc.	-
EC.02	3802h	-	-	-	0 : off	1 : on	1	0 : off	-
EC.05	3805h	-	-	-	5 kHz	10 kHz	0,01 kHz	10 kHz	-
EC.06	3806h	-	-	-	0 : standard	1 : high res.	1	0	-
EC.08	3808h	-	-	-	0	5	1	3	-
EC.09	3809h	-	-	-	- 1 : Auto	72 mA	0,1 mA	7,7 mA	-
EC.10	380Ah	✓	-	-	-	-	1	-	-
EC.11	380Bh	-	-	-	256 Inc.	10000 Inc.	1 Inc.	2500 Inc.	-
EC.12	380Ch	-	-	-	0 : off	1 : on	1	0 : off	-
EC.13	380Dh	-	-	-	0	1	1	0	-
EC.14	380Eh	-	-	-	0	13	1	0	-
EC.15	380Fh	-	-	-	0	1	1	0	-
EC.16	3810h	-	-	-	0	1	1	0	-
EC.18	3812h	-	-	-	0	5	1	0	-
EC.20	3814h	✓	-	-	-	-	1	-	-
EC.21	3815h	✓	-	-	-	-	1	-	-

- 1. Introduction
- 2. Summary
- 3. Hardware
- 4. Operation
- 5. Parameter
- 6. Functions**
- 7. Start-up
- 8. Special Operation
- 9. Error Assistance
- 10. Project Planning
- 11. Networks
- 12. Applications
- 13. Annex

- 6.1 Operating and Unit Data
- 6.2 Analog In- and Outputs
- 6.3 Digital In- and Outputs
- 6.4 Set Value and Ramp Adjustment
- 6.5 Motor Data and Controller Adjustment
- 6.6 Keep on Running Functions
- 6.7 Parameter Sets
- 6.8 Special Functions
- 6.9 Encoder Interface
- 6.10 Synchronous Control**
- 6.11 Positioning Module
- 6.12 CP-Parameter Definition

- 6.10.1 Gear Ratio 4
- 6.10.2 Position Controller 5
- 6.10.3 Calculation of the Set Position
..... 6
- 6.10.4 Synchronization 7
- 6.10.5 Register Function 10
- 6.10.6 Connection of Accessories for
Master-Slave Operation 12
- 6.10.7 Used Parameters 13

6.10 Synchronous Control

The synchronous module realizes a multi-motor synchronous control. Several motors can be operated

- speed synchronous
- angular synchronous

to a master drive (control drive). The speed relations are individually adjustable. The control drive must not be controlled. The synchronous module can only be activated when the inverter is fitted with a second incremental encoder input.

Is synchronous operation possible?

One look onto parameter In.57 answers this question. The following display indications mean:

- „0“ synchronous operation possible
- „4“ not possible
- „7“ synchronous operation possible when the interface is switched to input (dr.39 = „1“)
- „12“ synchronous operation possible when EC.13 = 1

! For synchronous operation the parameter Pc.16 must be adjusted on value 0 (factory setting)!

Fig. 6.10.1 Structure of the synchronous control

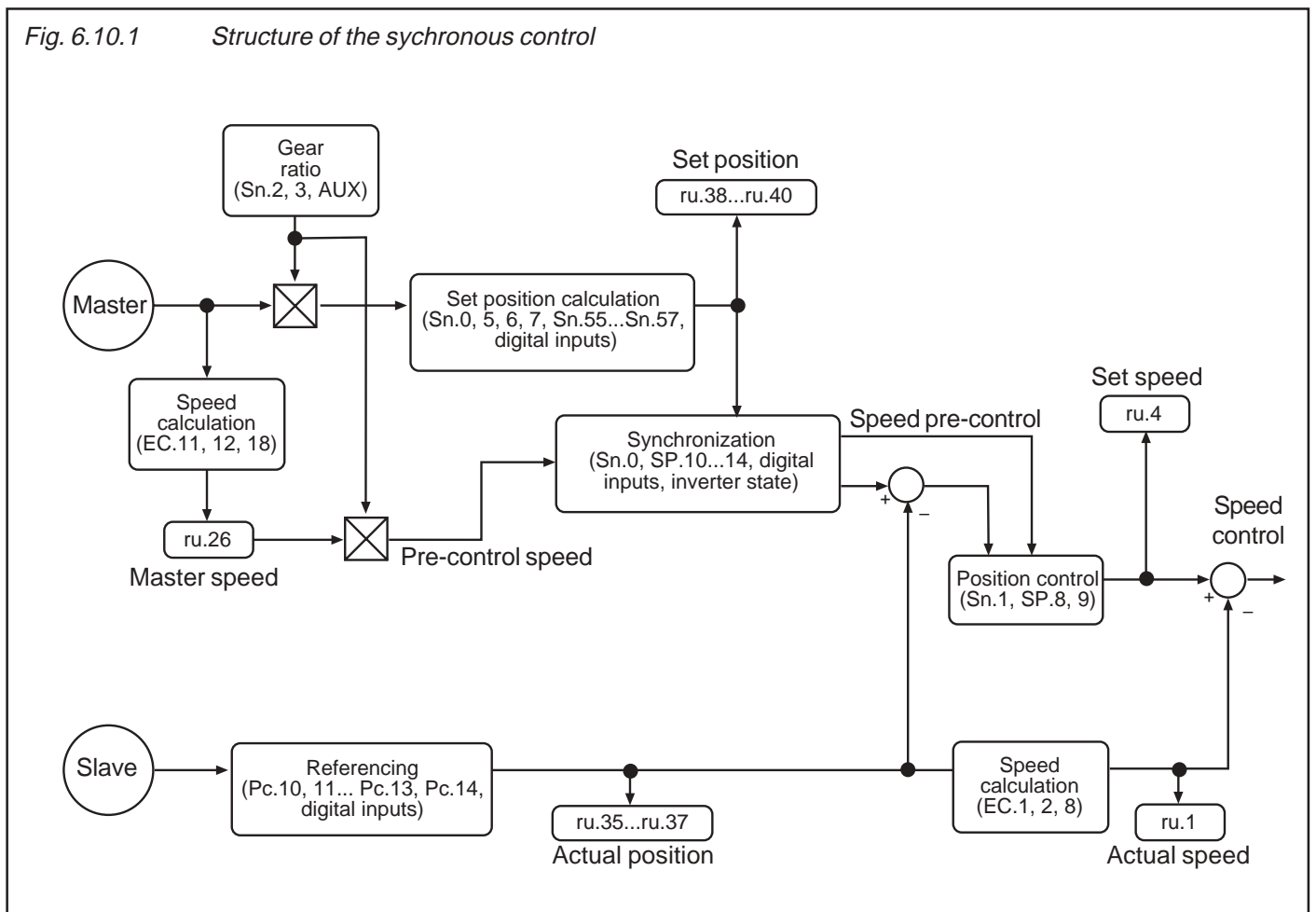

6.10.1 Gear Ratio

The gear ration between Master and Slave can be adjusted with the parameters Sn.2 and Sn.3 as well as the analog input AUX (if An.13 = 7 or 8).

Value range Sn.2 : -20...+20 / resolution 0,001

Value range Sn.3 : 0...+20 / resolution 0,001

AUX will be limited for the analog adjustment of the gear factor in the range of 0...100 %.

An.13	analog adjustment	Gear ratio
0...6, 9	no	Sn.2 / Sn.3
7	yes	$(\text{Sn.2} + \text{AUX} / 100\% \times 20) / \text{Sn.3}$
8	yes	$(\text{Sn.2} - \text{AUX} / 100\% \times 20) / \text{Sn.3}$

Example: Sn.2 = 2
 Sn.3 = 5
 AUX = 25%
 An.13 = 7

$$\text{Gear ratio} = \frac{2 + (25\% / 100\% \times 20)}{5} = 1,4$$

The gear ratio is signed; a negative value for the gear factor means reverse direction of Master and Slave.

A too large gear factor usually leads to an uneven running, since small changes of the Master speed have a large effects on the Slave.



The maximum difference between Master- and Slave position may not exceed 32.000 revolutions, since otherwise an overflow occurs!

6.10.2 Position Controller

The synchronous controller is a proportional controller, that calculates the setpoint speed from the setpoint and actual position, with which the Slave drive must operate in order to follow the Master in angular synchronism.

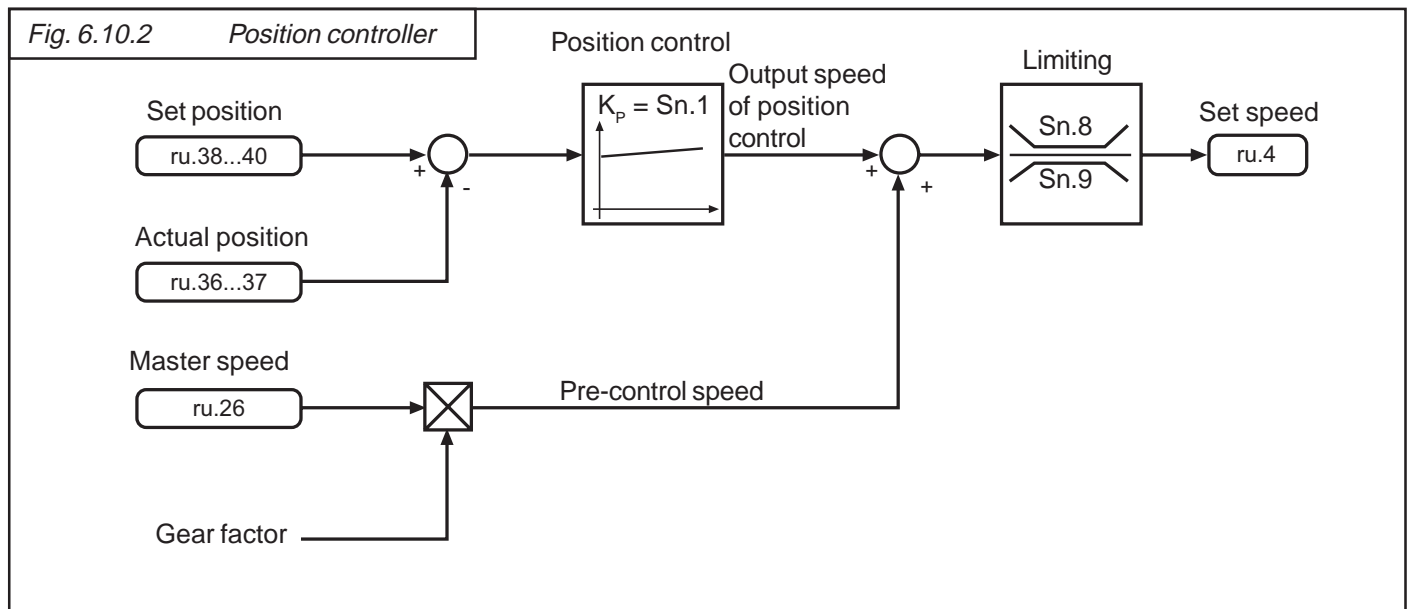

The K_p of the synchronous controller (Sn.1) is normed as follows:

$$\text{Output of the position controller in U/ min} = \frac{(\text{Set position (ru.38...40)} - \text{Actual position (ru.35...37)}) \times Sn.1}{2290}$$

To increase the dynamic a precontrol speed is added to the controller output. The precontrol speed is calculated as follows:

$$\text{Precontrol speed} = \text{Master speed} \times \text{Gear factor}$$

The sum of controller output + precontrol speed is limited by the absolute speeds for rotation direction clockwise (SP.8) or counter-clockwise (SP.9). This speed is the setpoint speed for the speed controller.

Sn.1	Function
0	Speed synchronous control
1...65535	Angle synchronous control with proportional term

If Sn.1 is = 0, the precontrol speed is the setpoint speed of the Slave, the drives run with synchronized speed.

Normally the synchronous control does not contain ramps. An exception is the phase of synchronization.

6.10.3 Calculation of the Set Position

The synchronous module is deactivated at: Sn.0 = 0
 or Pc.0 = 1
 or if an input with the input function 9 (synchronous controller 'off') is active.

Calculation of the Starting Position

If the synchronous mode is activated, the start value of the set position calculates in dependence of parameter Sn.0.

Sn.0	Starting value of the set position
1	Set position = Actual position
2,3	see Register function (6.10.6)
4	Set position = Actual position – Startoffset (Sn.55...57)
5	Set position = reference point position – Startoffset (Sn.55...57) ^{*1}

^{*1} To be able to use this function a reference point run is always necessary after Power-On, since otherwise the drive behaves as with Sn.0 = 1.

Calculation of the Position in Synchronous Operation

During synchronous is active, the set position is calculated as follows:
 (Exception synchronization / Chapter 6.10.4)

$$\text{Set position} = \text{Starting value} + \text{Gear factor} \times \text{Variation of the Master position} \text{ }^{*1}$$

^{*1} since activating the synchronous operation

The setpoint position can be changed by the functions 'Resetting angular difference' (digital input function 6), 'Angular shifting positive' (digital input function 7 or Sn.5 = 1) and 'Angular shifting negative' (digital input function 8 or Sn.5 = 2).

resetting angular difference: Set position = Actual position
 Angular shifting positive: Set position new = Set position old + Sn.6, 7
 Angular shifting negative: Set position new = Set position old – Sn.6, 7

Value range Sn.6 : 0...360° resolution 0,1°
 Value range Sn.7 : 0...10.000 U/ min resolution 1 U/ min

$$\text{Angular shifting} = \text{Sn.7} \times 360^\circ + \text{Sn.6}$$

Sn.5	Function
0	no correcture
1	correcture in positive direction
2	correcture in negative directon

Resetting angular difference

An angular difference between Master and Slave can be reset by the following measures:

- writing on parameter Sn.0
- setting digital input (deactivate synchronous control = value „9“)
- setting digital input (resetting angular deviation = value „6“)

6.10.4 Synchronization

When selecting Sn.0 = 4 or 5, the synchronization onto the Master can be done with ramps.

Synchronous running without ramps (Standard)

- Set speed 'jumps'
- Drive accelerates along the torque limit

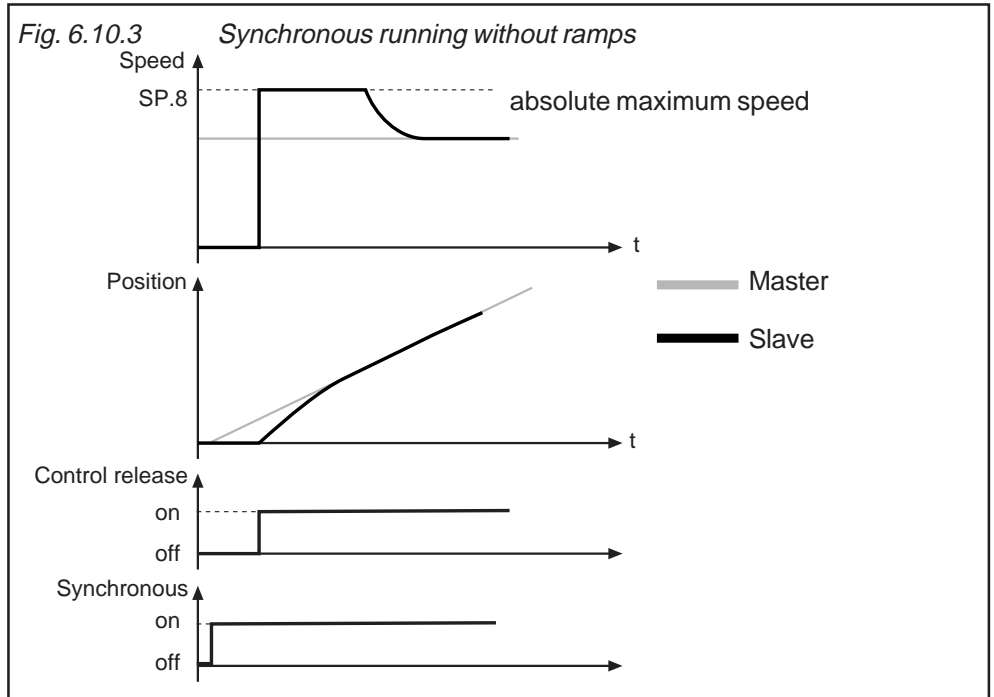

Synchronization with ramps

- Setpoint speed changes according to the adjusted ramp values (Sp.10...14)

The ramp values are determined at the start of the synchronization and cannot be changed during this operating status. There are no S-curves (Sp.15, SP.18 without function).

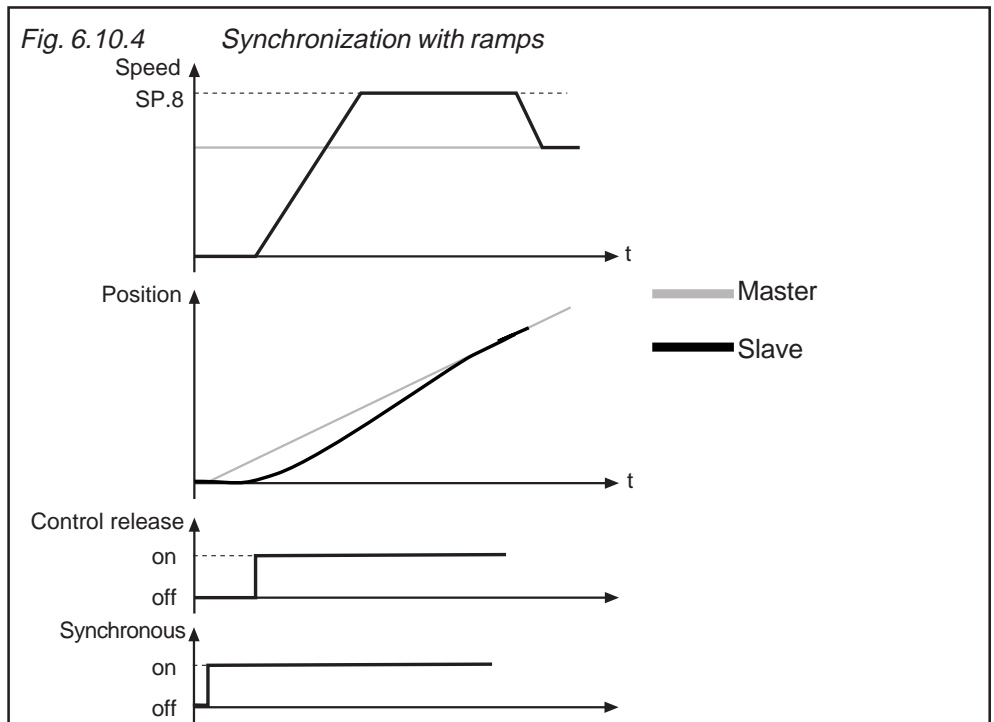

The synchronization is started, if:

- synchronous is activated
- the drive returns again to synchronous operation after a malfunction ('abnormal stop' or error)
- control release is given while synchronous is active
- the gear ratio is changed
- 'Angular shifting' positive or negative is activated
- 'Resetting angular difference' is activated

The synchronization is completed, if the Slave position corresponds to the Master position. After that the Slave follows the settings of the Master drive without ramps.

Thus the synchronization or the adjustment of the drives is achieved while being gentle on the mechanics, and the drive still remains dynamic and stable during the real synchronization run.

Synchronization with 'Wait'

Synchronization with 'Wait' can only occur at the activation of the synchronous operation.

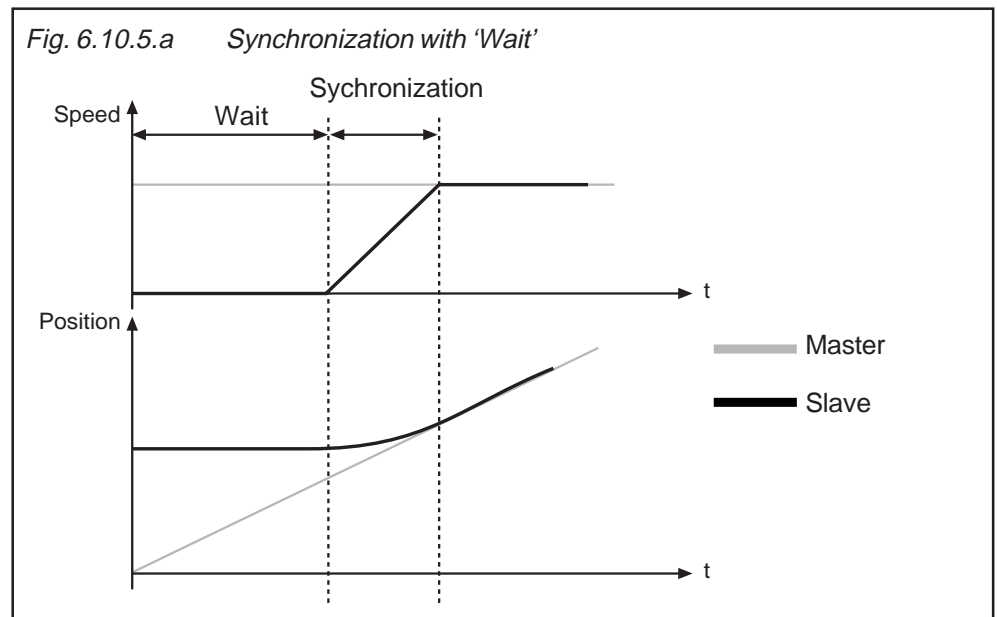

If the synchronous mode is activated and Sn.0 = 4 or 5 is selected, the Slave drive checks, if the Master moves to the actual position of the Slave, i.e.

- a) the Master rotates clockwise and the set position of the Slave is smaller than the actual position
- b) the Master rotates counter-clockwise and the set position of the Slave is larger than the actual position of the Master drive.

In that case the Slave waits with the start of the synchronization until it can move with its ramp directly onto the Master speed and thus is immediately synchronous with the Master.

If the Master changes its direction of rotation in this stage and departs again from the Slave position, then the Slave starts immediately and synchronizes onto the adjusted ramps accordingly.

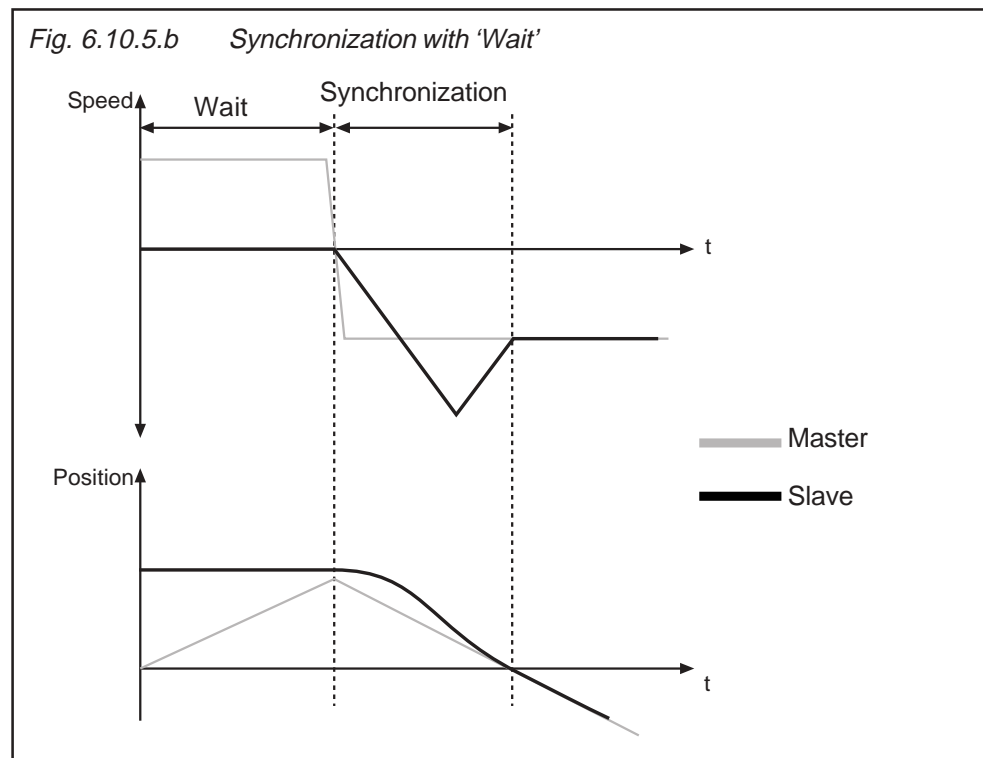

Calculation of the actual position and reference point approach see chapter 6.11.10

6.10.5 Register Function

In synchronous operation the possibility exists to synchronize Master and Slave additionally onto two reference signals. These reference signals are found for example at the master axis and the slave axis in form of proximity sensors. Through the register function the gear factor and the angular connection can then be activated until both reference signals are synchronized.

The ramps (only SP.11...SP.12) adjusted in the SP-parameters are active. Changes of the ramp values while the register function is active are not accepted. Acceptance of the ramp values only at start-register function.

The register function is activated by:

- Sn.0 = 2 Register function ON
- di.03 = off Input 1 always has the function of the master signal
- di.04 = off Input 2 always has the function of the slave signal
- di.05 = 9 Synchronous off

After the activation of the register function both initiator signals must come two times before the register function triggers an action.

If switching into a parameter set with Sn.00 = 3, the first calculated angular offset between master and slave is stored in Sn.30...Sn.32 (teach).

Register function period (Sn.08)

With this parameter the value is adjusted, by which the gear factor can change during a measuring period. A Measuring period means, that a positive edge was recognized at both reference signals. The changed gear factor remains permanently stored in Sn.02. If the gear factor can not be changed during a process, the value 0 should be pre-set in Sn.08. In that case only the angle is corrected.

Register function filter mode (Sn.21)

This mode is used for the suppression of interference signals at the two initiator signals.

Sn.21	Function
0	off
1	Master strobe: After a master signal only the next edge of the slave signal is used. Further slave signals are ignored.
2	Slave strobe: After a slave signal only the next edge of the slave signal is used. Further master signals are ignored.

Register function correction mode (Sn.25)

With this parameter the direction of the angular correction can be selected. In order to achieve a stable operation with only one direction of correction, the gear factor should be adjusted a little, so that the angular correction is always possible with one direction only.

Maximal angular correction (Sn.52...Sn.54)	The angle, which can be corrected maximally in one measuring period, is specified here. The value corresponds to one revolution of the motor. The angular correction can only operate, if a P-component is adjusted in Sn.01.
Period level for angular correction (Sn.22...Sn.24)	The angular correction can be suppressed with this parameter, as long as the deviation of the period is too large. So long as the value displayed in Sn.46...Sn.48 is larger than Sn.22...Sn.24, no angular correction is carried out.
Maximal value for angular correction (Sn.26...Sn.28)	The angular correction is not carried out, if the amount of the value displayed in Sn.49...Sn.51 is larger than this parameter.
Angular offset (Sn.29...Sn.36)	The setpoint value of the angular offset between master and slave signal is pre-set in these parameters. The angular offset can be pre-set as constant (Sn.33 = 0) or linearly interpolated in a speed range. If the angular offset is determined with the teach-function, the value is always written in Sn.29...Sn.31.
Slave ratio (Sn.20)	With active register function the ratio of master signal to slave signal can be adjusted here.
Slave register display (Sn.40...Sn.42)	These parameters display the distance travelled by the slave between two signals of input 2. One revolution of the slave corresponds to a value of 65535. This register is updated with every signal at I2.
Master register display (Sn.43...Sn.45)	These parameters display the distance travelled by the master between two signals of input 1. One revolution of the master encoder with the line number adjusted in EC.11 corresponds to a value of 65535. This value, multiplied by the gear factor Sn.02, is displayed in the master register. This signal is updated with every signal at I1.
Period display (Sn.46...Sn.48)	After master and slave register are written, the difference between these two values is represented in the period display. This calculation is triggered, if master signal and slave signal have been identified. After the initialization master signal and slave signal must each be identified two times. If the gear factor has been adjusted by the register function onto the suitable value, the period display shows approximately zero.
Period display (Sn.46...Sn.48)	This register is calculated simultaneously with the period display. The path of the slave between master signal and slave signal is displayed.





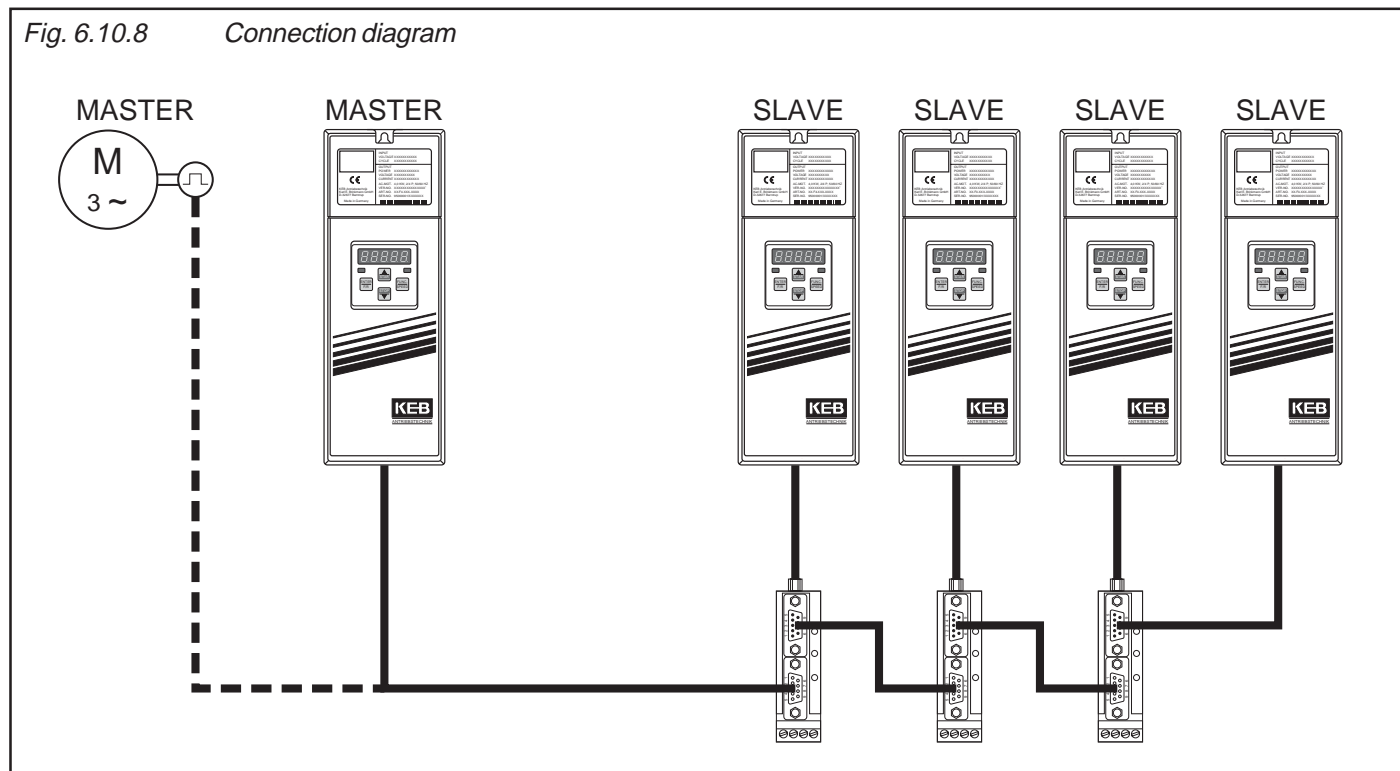

6.10.6 Connection of Accessories for Master-Slave Operation

For the master-slave operation with several slaves the MS-repeater 00.F4.072-2008 is available as well as ready-to-connect cables as accessory. For detailed information you can order the Instruction Manual of the MS-repeater.

Fig. 6.10.8 Connection diagram

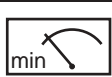
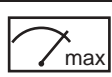

6.10.7 Used Parameters

Param.	Adr.								
Sn.0	3400h	✓	✓	-	0	3	1	0	0: off / 1: on
Sn.1	3401h	✓	✓	-	0 inc.	65535 inc.	1 inc.	0 inc.	-
Sn.2	3402h	✓	✓	-	-20	20	0,001	1	-
Sn.3	3403h	-	-	-	0,001	20	0,001	1	-
Sn.5	3405h	✓	-	✓	0	2	1	0	-
Sn.6	3406h	✓	-	-	0,0°	360,0°	0,1°	0,0°	-
Sn.7	3407h	✓	-	-	0 inc.	65535 inc.	1 inc.	0 inc.	-
Sn.8	3408h	-	-	-	0	0,100	0,001	0,001	-
Sn.22	3416h	-	-	-	0	2	1	2	-
Sn.23	3417h	-	-	-	0 inc.	65535 inc.	1 inc.	0 inc.	-
Sn.24	3418h	-	-	-	0 inc.	65535 inc.	1 inc.	0 inc.	-
Sn.25	3419h	-	-	-	0	2	1	0	-
Sn.26	341Ah	-	-	-	0	2	1	2	-
Sn.27	341Bh	-	-	-	0 inc.	65535 inc.	1 inc.	0 inc.	-
Sn.28	341Ch	-	-	-	0 inc.	65535 inc.	1 inc.	0 inc.	-
Sn.29	341Dh	-	-	-	0 rpm	15.000 rpm	0,5 rpm	0 rpm	-
Sn.30	341Eh	-	-	-	0	2	1	0	-
Sn.31	341Fh	-	-	-	0 inc.	65535 inc.	1 inc.	0 inc.	-
Sn.32	3420h	-	-	-	0 inc.	65535 inc.	1 inc.	0 inc.	-
Sn.33	3421h	-	-	-	0 rpm	15.000 rpm	0,5 rpm	0 rpm	-
Sn.34	3422h	-	-	-	0	2	1	2	-
Sn.35	3423h	-	-	-	0 ink.	65535 ink.	1 ink.	0 ink.	-
Sn.36	3424h	-	-	-	0 ink.	65535 ink.	1 ink.	2 ink.	-
Sn.40	3428h	-	-	-	0	2	1	2	-
Sn.41	3429h	-	-	-	0 inc.	65535 inc.	1 inc.	0 inc.	-
Sn.42	342Ah	-	-	-	0 inc.	65535 inc.	1 inc.	0 inc.	-
Sn.43	342Bh	-	-	-	0	2	1	2	-
Sn.44	342Ch	-	-	-	0 inc.	65535 inc.	1 inc.	0 inc.	-
Sn.45	342Dh	-	-	-	0 inc.	65535 inc.	1 inc.	0 inc.	-
Sn.46	342Eh	-	-	-	0	2	1	2	-
Sn.47	342Fh	-	-	-	0 inc.	65535 inc.	1 inc.	0 inc.	-
Sn.48	3430h	-	-	-	0 inc.	65535 inc.	1 inc.	0 inc.	-
Sn.49	3431h	-	-	-	0	2	1	2	-

Sn.50	3432h	-	-	-	0 inc.	65535 inc.	1 inc.	0 inc.	-
Sn.51	3433h	-	-	-	0 inc.	65535 inc.	1 inc.	0 inc.	-
Sn.52	3434h	-	-	-	0	2	1	2	-
Sn.53	3435h	-	-	-	0 inc.	65535 inc.	1 inc.	2 inc.	-
Sn.54	3436h	-	-	-	0 inc.	65535 inc.	1 inc.	16.834 inc.	-
Sn.55	3437h	-	-	-	0	2	1	2	-
Sn.56	3438h	-	-	-	0 inc.	65535 inc.	1 inc.	0 inc.	-
Sn.57	3439h	-	-	-	0 inc.	65535 inc.	1 inc.	0 inc.	-
In.57	2C39h	-	-	-	0	7	1	-	Value 0 or 7 for synch. operation
Pc.10	360Ah	✓	-	✓	0	5	1	0	-
Pc.14	360Eh	✓	-	-	-3000,0 rpm	3000,0 rpm	0,5rpm	100,0 rpm	-
Pd.1	3701h	✓	-	✓	1	3	1	0	-

- 1. Introduction
- 2. Summary
- 3. Hardware
- 4. Operation
- 5. Parameter
- 6. Functions**
- 7. Start-up
- 8. Special Operation
- 9. Error Assistance
- 10. Project Planning
- 11. Networks
- 12. Applications
- 13. Annex

- 6.1 Operating and Unit Data
- 6.2 Analog In- and Outputs
- 6.3 Digital In- and Outputs
- 6.4 Set Value and Ramp Adjustment
- 6.5 Motor Data and Controller Adjustment
- 6.6 Keep on Running Functions
- 6.7 Parameter Sets
- 6.8 Special Functions
- 6.9 Encoder Interface
- 6.10 Synchronous Control
- 6.11 Positioning Module**
- 6.12 CP-Parameter Definition

- 6.11.1 Activating Positioning Module (Pc.0, Pd.0) 3
- 6.11.2 Selection of Encoder Input for Position Feedback (Pc.16) 4
- 6.11.3 Gear Factor for Encoder Input 2 (Pc.17) 4
- 6.11.4 Display Mode of Position Values (Pc.1) 6
- 6.11.5 Calculation of the Position profile and Speed Precontrol ... 7
- 6.11.6 Position Controller (Pd.2) 10
- 6.11.7 Software Limit Switch (Pc.4..9) 10
- 6.11.8 Determining of the Set-Position 11
- 6.11.9 Variation of the Set-Position .. 13
- 6.11.10 Determining of the Actual-Position 16
- 6.11.11 Switching conditions for Posi 20
- 6.11.12 Adjustment of Position Controller and Drive Profile 22
- 6.11.13 Check List 24
- 6.11.14 Programming Examples 25
- 6.11.15 Used Parameters 32

Chapter 6	Section 11	Page 2	Date 18.12.02	Name: Basis KEB COMBIVERT F4-F	© KEB Antriebstechnik, 2002 All Rights reserved
---------------------	----------------------	------------------	------------------	--	--

6.11 Positioning Module

The KEB COMBIVERT F4-F permits the storing and the position-controlled approach of up to 8 positions. The position setting is based on the parameter set programming, at that one position can be deposited in each parameter set.

The position setting and display can be done either in increments or revolutions. Through the Teach-function it is possible to read-in the actual position as setpoint position value.

Basically one revolution is divided into 65536 (2^{16}). (Only systems with sine-wave signals 1 Vss allow the utilization of this high resolution.)

The entire value range for position settings lies at 4.294.967.296 (2^{32}) increments.

The positioning can be done relative to the actual position or to a fixed absolute position. The drive profile (maximum speed, ramps, position controller) is individually adjustable for every positioning set.

6.11.1 Activating Positioning module (Pc.0, Pd.0)

Parameters Pc.0, Pd.0 and Sn.0 permit the change between the different modes (see Fig. 6.11.1).

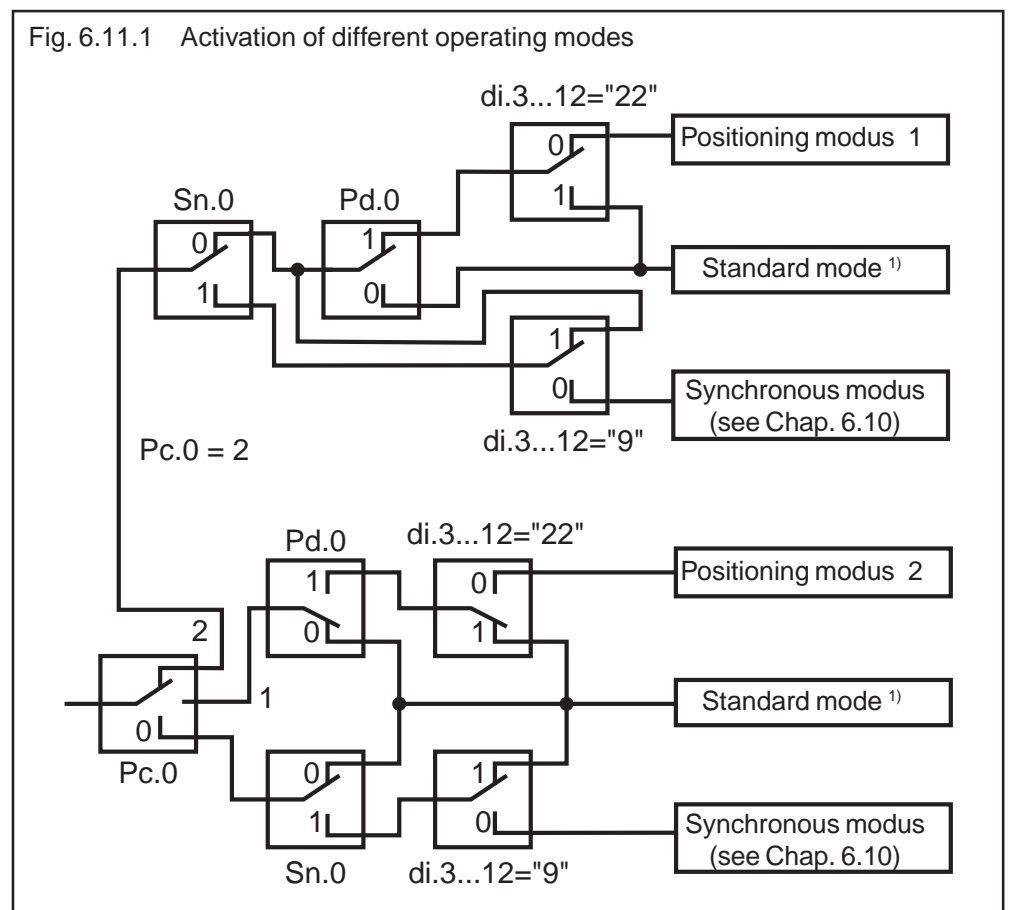

By means of a digital input (di.3...di.12) the synchronous module (value 9) or the positioning module (value 22) can be deactivated and it can be changed to the standard mode.

) Posi is active at Pd.0 = 1 or 2

¹⁾ Speed- / torque controlled operation

Posi Mode (Pc.0) Changing the parameter is only possible without control release (ST). This parameter indicates the control mode

Pc.0	Function
0	Synchronous- / speed-controlled
1	Position- / speed-controlled
2	Synchronous- / position- / speed-controlled

The listing sequence behind the parameter values also represents the priority, after all functions are selected. Only in Pc.0 = 2 it can be switched directly between Posi and synchronous.

Naturally the torque-controlled operation is also possible, however it is not possible to jump from this mode directly to the Posi- or synchronous module. That is only possible in the speed-controlled mode.

Special functions at Pc.0 =2 In the positioning mode (Pc.0 = 2) are the following expansions available:

- different ramps and s-curve times for acceleration and deceleration
- variation of the maximum positioning speed during the active positioning
- immediately reaction on new position settings during an active positioning
- different procedures of abort of a positioning
- Start positioning with start-up speed

Activate positioning (Pd.0) With parameter Pd.0 the positioning can be activate. Pd.0 is set programmable.

Pd.0	Function
0	Posi off Deactivating of the positioning mode
1	Posi on Activate the positioning mode, deactivating digital input possible
2	Posi on + Auto-Start like 1, additionally automatical 'Start-Posi'-command, at set-selection

6.11.2 Selection of Encoder input for the Position feedback (Pc.16)

The position feedback for the positioning module can be made by way of the system feedback (encoder input 1) or over a second encoder (encoder input 2):

Pc.16	Position Feedback by
0	Encoder input 1 (X4)
1	Encoder Input 2 (X5)

A change of the parameter values is only possible in „noP“ state.

If the encoder input 2 is used as feedback then all position settings refer to this encoder. 65536 increments at the position setting correspond to one revolution of this second encoder.

The parameters for the precontrol profile Pd.5 to Pd.7 always refer to the encoder input 1 (system feedback / responsible for speed control).

6.11.3 Gear Factor for Encoder Input 2 (Pc.17)

When the position encoder at encoder input 2 is connected to the motor by way of a gear unit, the gear ratio must be adjusted here (encoder at encoder input 1 must always be connected directly to the motor shaft).

Pc.17	Setting range: 1,00 ... 250,00 Resolution: 0,01
-------	--

A change of the parameter values is only possible in „noP“ state.

Fig. 6.11.2 Positioning mode

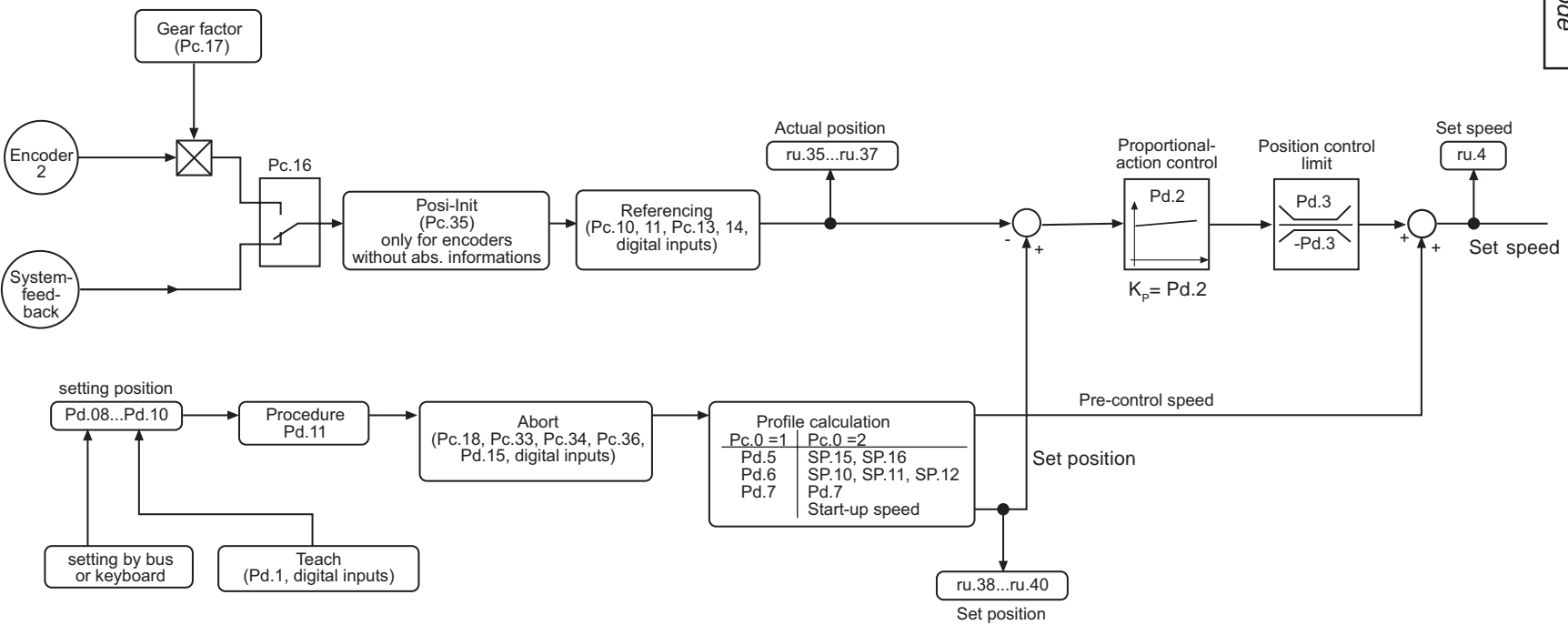

6.11.4 Display Mode of Position Values (Pc.1)

The position adjustment/display can be made in two different ways:

- in revolutions: The adjustment/display is done with two parameters (Pd.9, Pd.10). One parameter indicates complete revolutions sign-dependent on -32768...32767 . With the other parameter partial revolutions in the range of 0...65535 are adjusted (1 revolution = 65536).
- in increments: The adjustment/display is effected by three parameters in increments. By increments we do not mean the encoder line number, but the internal resolution of 65536 increments per revolution of the position encoder. The first parameter adjusts the rotation direction. The second parameter adjusts the increments : 10000 (display value • 10000 = increments). The third parameter adjusts the increments = display value.

Parameter Pc.1 defines how the position values are displayed or adjusted.

Pc.1	Position Display	Position Adjustment
0	in increments	in increments
1	in increments	in revolutions
2	in revolutions	in increments
3	in revolutions	in revolutions

Value range at display/adjustment in

- revolutions: -32768...32767 revolutions; rotation direction through sign
- increments: 0...655.360.000 increments (corresponds to 10.000 revolutions); rotation direction through additional parameter
- resolution: The internal resolution of 65536 increments / revolutions can be achieved only with sine-wave signals.

Setpoint/Actual Position and Position Setting (Pd.8...Pd.10; ru.35...ru.40)

Positions are displayed/adjusted through following parameters:

	Rotation direct. (*)	Position High	Position Low
Position setting	Pd.8	Pd.9	Pd.10
Actual position/display	ru.35	ru.36	ru.37
Setpoint position/display	ru.38	ru.39	ru.40

* Valid only for adjustment / display in increments, otherwise by the sign of the parameter position high.

 The difference between two successive positions may not exceed half of the setting range.

6.11.5 Calculation of the Position Profile and Speed Precontrol

With these parameters it is possible to assign an individual speed precontrol profile to every position. However, the preadjusted values can only be kept if neither general torque limits nor the maximum speed (SP.8 (SP.9) are exceeded.

(also see chapter 6.11.11)

Fig. 6.11.11 Profile of speed precontrol

Pc.0 =	1	2
t _{S_Curve 1}	Pd.5	SP.15
t _{S_Curve 2}	Pd.5	SP.16
t _{acc}	Pd.6	$\frac{Pd.7}{SP.10} \cdot SP.11$
t _{dec}	Pd.6	$\frac{Pd.7}{SP.10} \cdot SP.12$

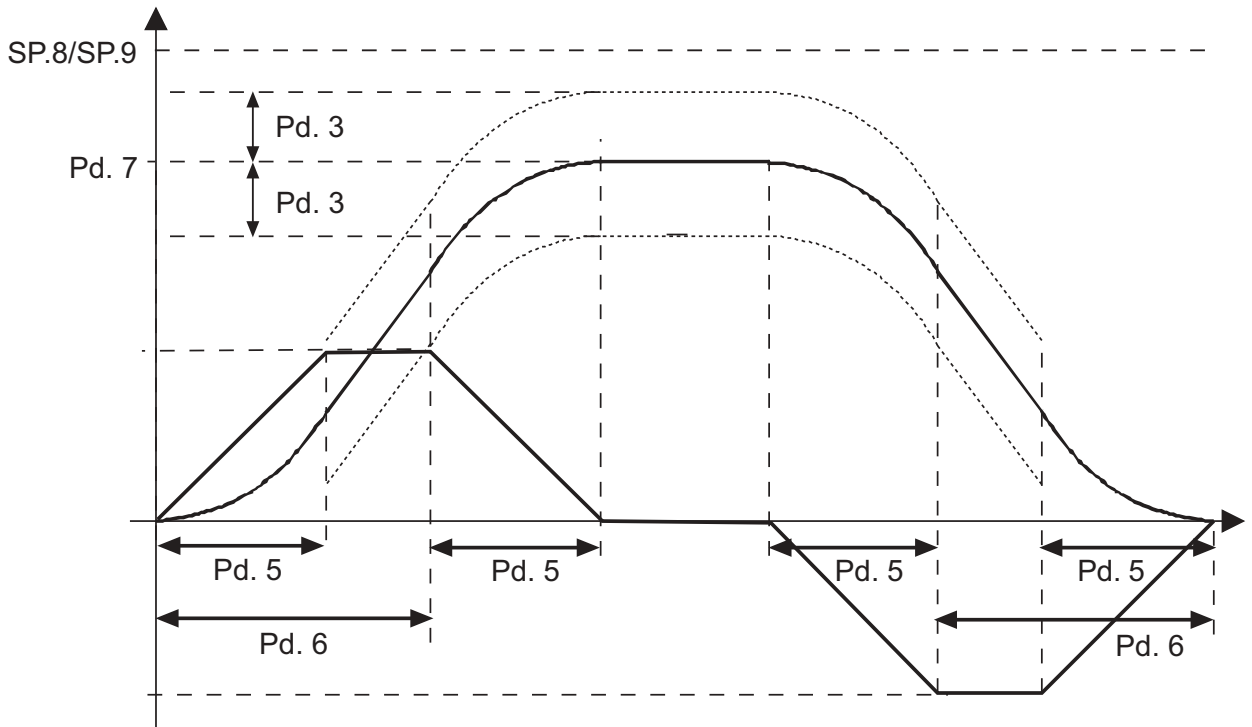

- Pd.3 Limit position control
- Pd.5 S-Curve time
- Pd.6 Acceleration time
- Pd.7 Maximum speed
- SP.8 Abs. max.speed right
- SP.9 Abs. max.speed left
- SP.10 Speeddiff. acceleration/ deceleration
- SP.11 Acceleration time right
- SP.12 Deceleration time left

As shown in Fig. 6.11.11 it must be observed that the setting of SP.8 / SP.9 is larger than the setting of Pd.7 + Pd.3.

Limit of position controller (Pd.3) Adjustment of the speed difference which the position controller may add to the profile of the speed precontrol. The maximum setpoint speed for the positioning is calculated from Pd.7 + Pd.3. Pd.3 can be set to 0,0...500,0 revolutions.

S-curve time (Pd.5, resp. SP.15, SP.16) For positionings that require a jerk-free starting s-curves are adjustable with Pd.5, which are executed during acceleration and deceleration. The S-curve time is adjustable at Pc.0 = 1 in the range of 0,01...8,00 s or at Pc.0 = 2 by Sp.15...SP.16. (SP-Parameters see chapter 6.4)

Acceleration time (Pd.6, resp. SP.10, SP.11, SP.12) Adjusts the acceleration time in the range of 0,01...8,00 s. In case the torque limit is reached during a positioning procedure the required torque can be lowered by extending the acceleration time.

	Pc.0 = 1	Pc.0 = 2
Acceleration	Pd.7/Pd.6	SP.10/SP.11
Deceleration	Pd.7/Pd.6	SP.10/Sp.12

Example: Pc.0 = 1 / Pd.7 = 1.500 min⁻¹ / Pd.6 = 5 s

$$\text{Acceleration} = \frac{1500 \text{ min}^{-1}}{5 \text{ s}} = 300 \frac{\text{min}^{-1}}{\text{s}}$$

Value range: Pd.6 : 0,01...8,00s
SP.10...SP.12 : see chapter 6.4

Maximum speed (Pd.7) With Pd.7 the maximum speed of the precontrol profile is defined. The adjusted value may be exceeded maximally by the speed difference of the position controller (Pd.3). But the absolute maximum frequencies (SP.8 / SP.9) cannot be exceeded.

Absolute maximum speed (SP.8, SP.9) The absolute maximum speed also limits the setpoint speed and can be adjusted separately for both directions of rotation. These parameters represent absolute limit values which in normal operation are not exceeded and which have no effect on the speed characteristic.

Angular difference (ru.27) At activated positioning module the contouring error (deviation of actual position to setpoint profile) is indicated in ru.27 in steps of 0.1 degree.

Positioning with start-up speed

At Pc.0 = 1 the positioning profile is always calculated beginning with the initial speed 0.

At Pc.0 = 2 it is also possible to start the positioning from any starting speed.

As long as the positioning is deactivated (Pd.0 = 0 or digital input is set to function 22 = 'Posi off'), the controller runs with its setpoint speed value.

If the positioning is activated, the controller stores the current setpoint value for speed-controlled operation and runs up to it. Exception: If at the time of activation the drive is in status 'noP' or in an error status it changes immediately into the position-controlled mode (i.e. the drive does not run up to the setpoint speed value). Otherwise on reaching the status 'Constant operation' the status 'Ready for positioning' is indicated and the positioning can be started with the command 'Start positioning'. This command can already be given while the drive runs to its setpoint speed value.

If the direction of rotation of the starting speed is opposite to the positioning direction, then the drive reverses automatically and approaches the target position.

After the first positioning the controller always starts from the initial speed Zero. So positioning from a starting speed takes place only immediately after activation of the positioning.

Fig. 6.11.4 Positioning with start-up speed

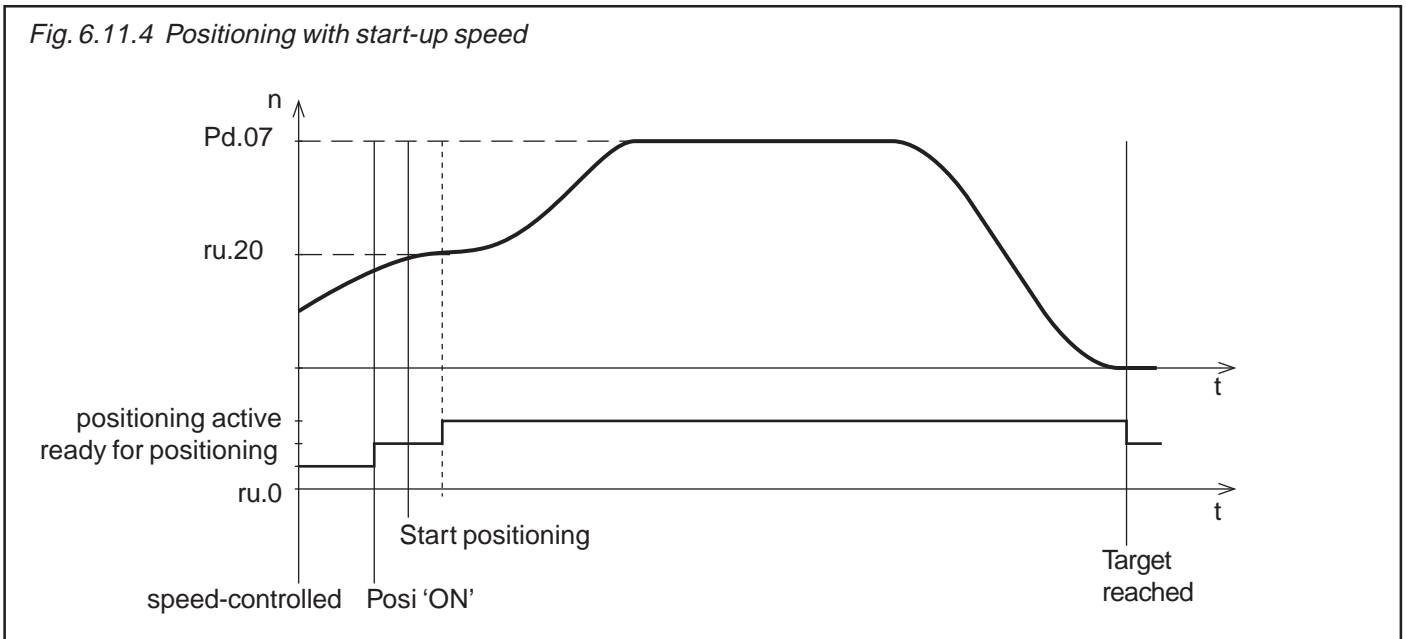

6.11.6 Position Controller (Pd.2)

With Pd.2 the position controller can be individually optimized for every approached position. Provided that the total position adjustment supplies satisfactory results, an optimization can become necessary in following cases:

- target position is not reached
- drive moves beyond the target position and returns then

This may be caused by a position controller which is adjusted too smooth. With Pd.2 the controller can be adjusted in the range of 0...65535 (default value 20).

6.11.7 Software Limit Switch (Pc.4...Pc.9)

The software limit switches determine the range in which positions can be approached. If at the starting of the positioning the target position lies outside this range, then one of the following errors is triggered:

- **E.SLF** (Error Software Limit Forward) Position outside the right software limit switch
- **E.SLr** (Error Software Limit Reverse) Position outside the left software limit switch

Depending on the selected position setting (revolutions or increments) different value ranges apply.

Since the parameters are not locked against each other it is absolutely necessary to ensure that with regard to the adjusted value the left software limit switch is located to the left of the right software limit switch. Following parameters define the software limit switches:

- Left software limit switch

Pc.4	Sign	(only at setting by way of increments)
Pc.5	High	(increments x 10.000 / complete revolutions)
Pc.6	Low	(increments x 1 / partial revolutions)
- Right software limit switch

Pc.7	Sign	(only at setting by way of increments)
Pc.8	High	(increments x 10.000 / complete revolutions)
Pc.9	Low	(increments x 1 / partial revolutions)

Deactivation of software limit switch

In the case of relative positioning (e.g. clock drive) the software limit switches can be deactivated (factory setting). Following procedure must be carried out:

- Select position setting in revolutions Pc.1 = 3
- Adjust left software limit switch to negative upper range value

Pc.5 = -32768
Pc.6 = 0
- Adjust right software limit switch to positive upper range value

Pc.8 = 32767
Pc.9 = 65535

The behaviour at tripping of the faults ESLF and E.SLr is defined with Pn.20 according to following table:

6.11.8 Determining of the Set-position

The setpoint position can be preset in increments as well as in revolutions. This is done in the parameters Pd.8...Pd.10 by adjusting increments or in the parameters Pd.9...Pd.10 by adjusting revolutions.

Position Setting in Increments (Pd.8...Pd.10)

Regarding the position setting in increments the rotation direction is adjusted by way of the sign in parameter (Pd.8). A complete revolution is represented internally with a resolution of 65536 increments. The 'high'- parameter (Pd.9) contains the increments x 10.000, the 'low'-parameter (Pd.10) contains the increments x 1. Please note that, when making the adjustment by way of the operator, the last digit as of 32767 is not indicated in parameter Pd.9.

Example for position setting in increments (relative positioning)

a) The drive shall run 13,75 revolutions clockwise

Pd.8 = 0 (+; forward)

$$13,75 \cdot 65536 = 901.120 = 90 \cdot 10.000 + 1120$$

Pd. 9 = 90

Pd. 10= 1120

b) The drive shall run 13,75 revolutions counter-clockwise

Pd.8 = 1 (-; reverse)

$$13,75 \cdot 65536 = 901.120 = 90 \cdot 10.000 + 1120$$

Pd. 9 = 90

Pd. 10= 1120

Position Setting in Revolutions (Pd.9, Pd.10)

The adjustment/display is effected with two parameters (Pd.9, Pd.10). Pd.9 indicates complete revolutions in the range of -32768...32767 an. The rotation direction is determined by the sign. With Pd.10 partial revolutions in the range of 0...65535 are adjusted (65536 = 1 revolution of the position encoder).

Please note that, when making the adjustment by way of the operator, the last digit in the negative range starting at -9999 is not indicated by Pd.9.

Examples for position setting in revolutions (relative positioning)

a) The drive shall run 13,7 revolutions clockwise (forward)

Pd.9 = 13 (or 0Dh)

Pd.10 = 0,7 • 65536 = 45875 (or B333h)

b) The drive shall run 13,7 revolutions counter-clockwise (reverse)

-13,7 revolutions = -14 + 0,3 revolutions (since only positive partial revolutions)

Pd.9 = -14

Pd.10 = (1 - 0,7) • 65536 = 19661 (or 4CCDh)

Fig. 6.11.4 Example for position setting in revolutions

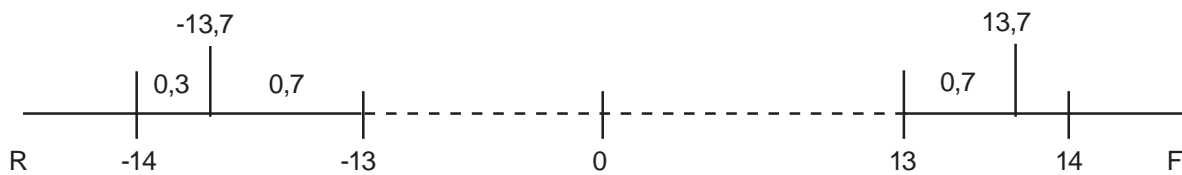

Teach - Function (Pd.1)

With the Teach-function positions are manually approached and stored in the respective set by switching from Pd.1 to „3“. The Teach-function is only possible for absolute setpoint positions.

Procedure:

- Activate positioning module (Pc.0 = 1)
- Deactive positioning (Pd.0 = 0)
- Approach the desired position at low speed (e.g. with jogging)
- Select the set, in which the position shall be stored (by way of digital inputs or parameter Fr.4)
- Actual position is stored as setpoint position in the selected set (switch Pd.1 to 3)
- Approach the next position
- Select the next set
- Actual position is stored as setpoint position in the selected set (switch Pd.1 to 3)
- and so forth

Relative/Absolute Positioning (Pd.11)

In Pd.11 it is selected whether the position setpoint value is adjusted absolute or whether it should be proceeded relative to the momentary position. At successive relative positioning cycles the new position is calculated on the basis of the momentary position **setpoint value**, i.e. position errors are not added up.

Pd.11	Procedure
0	absolute
1	relative

6.11.9 Variation of the Set-position

During a running positioning two possibilities are available to change the target position.

new position setting during positioning

At Pc.2 = 2 new position set values are accepted as new target position even during a running positioning. If the new position can be approached with the adjusted ramps, a standard positioning is executed. If the distance, which the controller would still travel even with immediate deceleration, is larger than the remaining distance to the target, it is adjusted with Pd.15, how the inverter shall respond. If the new position is adjusted when the drive is already in the stage of deceleration (i.e. on the finish line of the old position) the positioning onto the old target is completed. Parameter Pd.15 determines, whether the new target is then approached automatically.

Fig 6.11.6 New position setting during positioning

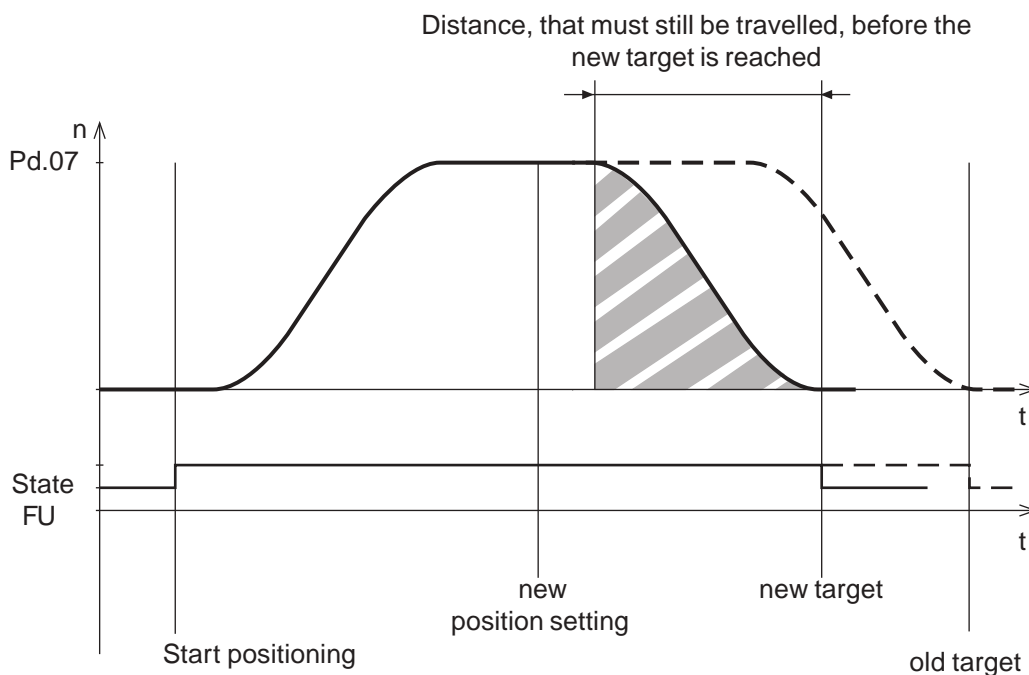

Pd.15 / 1. Function (2. Function see page 6.11.15)

Pd.15	new positioning during posi active
0	The controller stops with the adjusted ramps.
1	The controller stops and then drives to the new position without new 'start-posi'-command.
2	The controller ignores the new position and to the old position. The new position remains as the new set-position.
3	The controller drives to the old position and then stars the positioning onto the new position automatically.

A message can be generated (do.0X = 37), that indicates that the new target cannot be reached with a standard positioning (see Chapter 6.11.15).

Abort positioning

The positioning can be aborted over a digital input with the input function 25 = 'Posi abort'. For this function to become active a value unequal zero must be preset for the residual distance after abort (Pc.18, Pc.19).

All parameters for the positioning abort are set-programmable and, independent of the setting in PC.1, are always adjusted in revolutions.

Once the drive has recognized an abort-command, a change of the maximum speed or the adjustment of a further abort-command is not possible anymore, independent of the setting in Pd.15. The presetting of a new target position has priority over an abort-command.

Fig 6.11.7 Abort positioning with residual distance

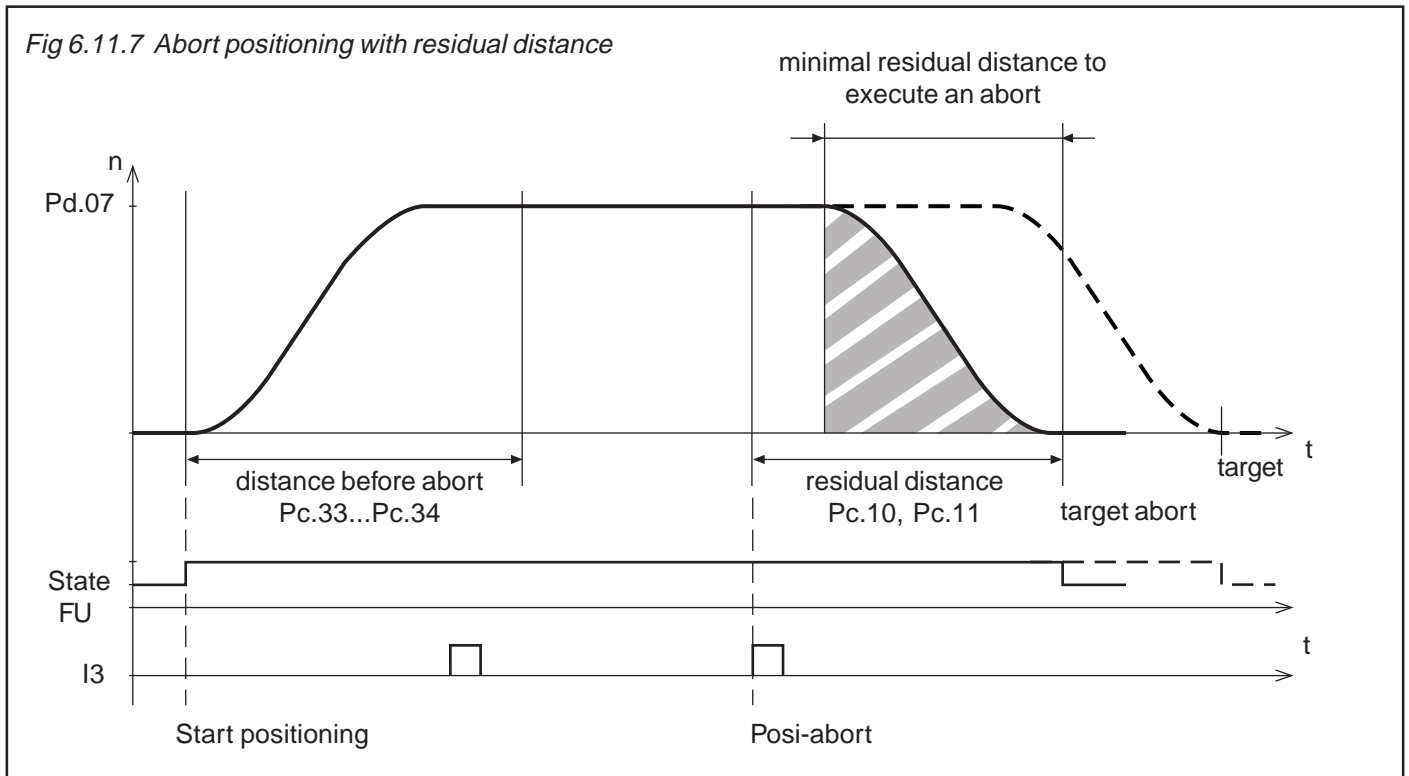

Residual distance after abort (Pc.18...Pc.19)

If the command is identified, then the new target position is the total sum of the current actual position (ru.35...37) and the residual distance after abort (Pd.18...19). If the drive is already in the stage of deceleration (i.e. on the finish line of the original setpoint position), an abort is not executed anymore.

Target mode (Pd.15)

If the distance, the controller would still have to travel even with immediate start of deceleration, is larger than the remaining residual distance to the new target, it is adjusted with Pd.15, how the inverter shall respond.

**Pd.15 / 2. Function (1.
Function see page 6.11.13)**

Pd.15	Positionabort with residual distance
0	The controller stops and returns a message (do.0X = 37), that it could not reach the residual distance position.
1	The controller stops and returns a message (do.0X = 37), that it could not reach the residual distance position.
2	The controller ignores the position abort, drives to the position and returns a message (do.0X = 37), that it could not reach the residual distance position.
3	The controller stops and returns a message (do.0X = 37), that it could not reach the residual distance position.

**Distance before abort
(Pc.33...Pc.34)**

During the positioning with abort (Pc.18 or Pc.19 uneven 0) a path can be pre-set in which the initiator signal for the abort shall not be evaluated.

Posi stop mode (Pc.36)

Pc.36	Function
0	State-active / residual distance after stop
1	Edge-active / residual distance after stop
2	State-active / stop before target position
3	Edge-active / stop before target position

'Stop before target position' means that the abort maximally runs to the originally adjusted target position (target position before abort). With the setting 'Residual distance after stop' the residual distance (Pc.18, Pc.19) is in any case still travelled after recognizing the stop signal. Edge-active means that the 'Posi abort command' is executed only if the signal edge comes during the current positioning. With 'Status active' the signal edge of the abort command can come before the 'Start positioning command'. If the abort signal is still active at the start of the positioning, then the abort is executed immediately.

6.11.10 Determining of the Actual Position

Posi-Init (Pc.35) After power-on the position of the system without absolute encoder is unknown. With parameter Pc.35 the position can be predetermined.

Pc.35	Funktion
0	zero During the switch-on of the unit, the actual position is reset.
1	absolute Normally a referencing is necessary The actual position is stored in the unit. Provided the axis is not twisted in de-energized condition no referencing is necessary.
2	absolute / relative positioning with correction Like 1, additionally after switch-on with the initial start position an aborted relative positioning is terminated.

Reference Point Approach To put a drive into the required original position after Power-on, a reference point approach can be carried out after switch on. Following conditions must be provided for a reference point approach:

- limit switch
- reference point switch
- input for starting the reference point approach (if not by bus/keyboard)

Programming of digital inputs (di.3...di.6, di.11, di.12)

Value	Function of di.3...di.6, di.11, di.12
10	Start reference point approach ¹⁾
11	Start reference point approach inverted ²⁾
12	Reference point switch
16	Right limit switch
17	Left limit switch
20	Right limit switch with reference point switch ³⁾
21	Left limit switch with reference point switch ⁴⁾

- ¹⁾ Starts the reference point approach with the preferred direction adjusted in Pc.14.d
- ²⁾ Starts the reference point approach contrary to the preferred direction adjusted in Pc.14.
- ³⁾ If the right limit switch is used at the same time as reference point switch, then the reference point approach must be started with preferred direction clockwise.
- ⁴⁾ If the left limit switch is used at the same time as reference point switch, then the reference point approach must be started in preferred direction counter-clockwise.

For further information regarding the adjustment of digital inputs see Chapter 6.3.

Speed of reference point approach (Pc.14)

The speed, with which the reference point search shall be carried out, can be adjusted in the range of -3000,0...3000,0 min⁻¹ with Pc.14. The standard value of 100,0 min⁻¹ can be kept for most applications.

- Positive values apply to preferred direction clockwise
- Negative values apply to preferred direction counter-clockwise

Manual start (Pd.1) The reference point approach can be started by way of a digital input (see above); with parameter Pd.1 (value „2“) or with the first „Start positioning“ command (see Pc.10).

Pd.1	Function
0	Positioning disabled
1	Start positioning
2	Starting reference point approach
3	Teach-Function
4	Set reference point

Mode of position reference (Pc.10) This parameter defines, how to start the reference point approach and how the drive behaves after reaching the reference point.

Starting reference point approach

Pc.10	Function
0, 2, 4	by bus or keyboard through writing on Pd.1 (Pd.1 = 2) or by digital input with input function 'Reference point approach' (di.x = 10 or 11)
1, 3, 5	with the first 'start-positioning'- command after restart the inverter. The 'start-positioning'- command can be released by - bus or keyboard (Pd.1 = 1) or - digital input with input function 'start-positioning' (di.x = 19). If the reference point approach is aborted (e.g. due to an error or taking away the control release), then the reference point approach is started again with the next 'Start positioning' command until it is completed once. In this mode the reference point approach can also be started with a digital input that has the function Reference Point Approach or with Pd.1 = 2. .

Behaviour of the drive after reaching the reference point:

Pc.10	Function
0 and 1	After reaching the reference point the drive continues to the reference mark of the encoder. This position is the reference point for all subsequent positionings (Example 1a). If from switching on of the inverter until reaching the reference point switch the reference mark of the encoder was not recognized (drive already stands shortly before the reference point switch when starting the reference point approach), the drive reverses and searches for the reference point mark of the encoder. If it is found the drive reverses once more and approaches the reference point switch again. If no reference point mark is found, the drive will stop after two revolutions and show E.EnC (Example 1c)
2 and 3	Drive reverses after reaching the reference point switch, clears it again and stops (without ramps). The position, at which the drive stops, becomes the reference point for all subsequent positionings.
4 and 5	Function, just like value 0 and 1, but E.EnC is triggered if the reference point switch is reached before the reference mark of the encoder was identified.

Reference Point Approach Examples

With two limit switches and one reference point switch; reference point run with approach of the reference marking of the encoder.

Example 1a

- Terminal X2.3 = limit switch right (di.11 = 16)
- Terminal X2.4 = limit switch left (di.12 = 17)
- Terminal X2.5 = reference point switch (di.3 = 12)
- Reference speed -100 min^{-1} with preferred direction counter-clockwise (Pc.14 = -100)
- Starting of reference point approach with X2.7 (di.5 = 10) **or** by bus / PC with parameter Pd.1 = 2 (Pc.10 = 0)

If the zero pulse shall not be approached (Pc.10 = 2), then only the reference point switch is cleared and the drive stops then.

Fig. 6.11.1.a Reference point approach example 1a

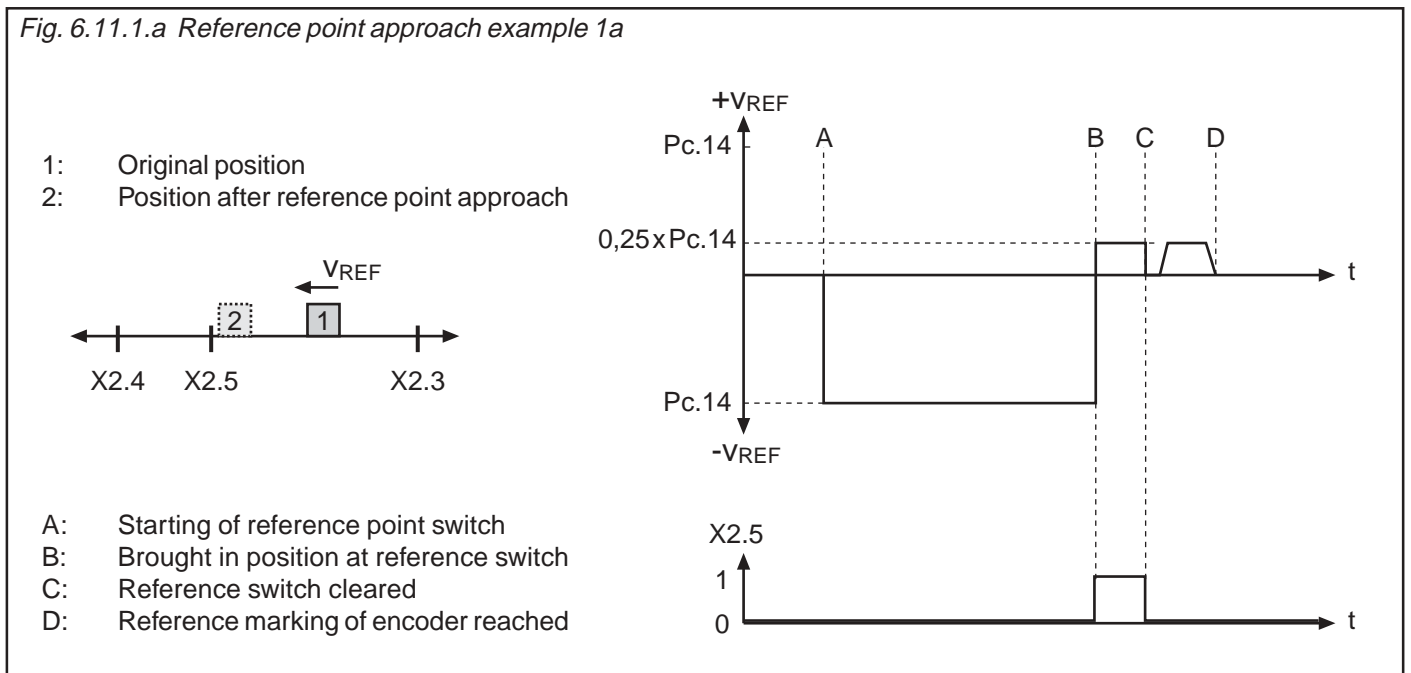

Example 1b

Like example 1a, but the drive reaches the limit switch first, then reverses and reaches the reference point opposite to the preferred direction. Since the referencing must always take place in the preferred direction, the reference switch is overtravelled, the drive reverses and now executes the referencing with the correct rotational direction.

Fig. 6.11.8.b Reference point approach example 1b

- 1: Original positioning
- 2: Brought in position at limit switch
- 3: Brought in position at reference point switch
- 4: Position after reference point approach

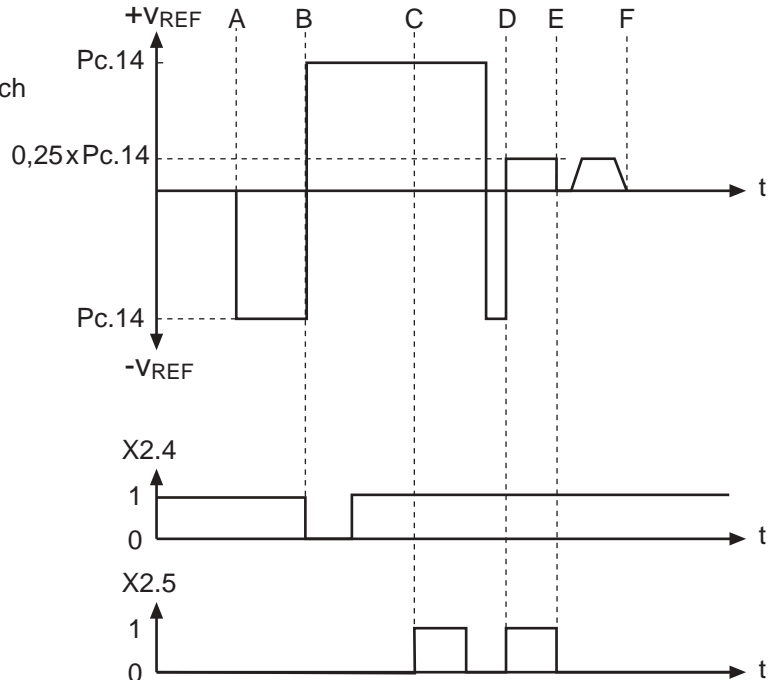
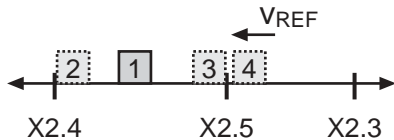

- A: Starting reference point approach
- B: Brought in position at limit switch
- C: Brought in position at reference switch
- D: Reference switch cleared, drive reverses and reference switch is approached again in preferred direction
- E: Reference switch cleared
- F: Encoder to reference marking

Example 1c Like example 1a, but to preferred direction.

Fig. 6.11.8.c Reference point approach example 1c

- 1: Original positioning
- 2: Brought in position at limit switch and reverse to search for reference marking of the encoder
- 3: Found reference marking, reverse to approach the reference switch out of the preferred direction

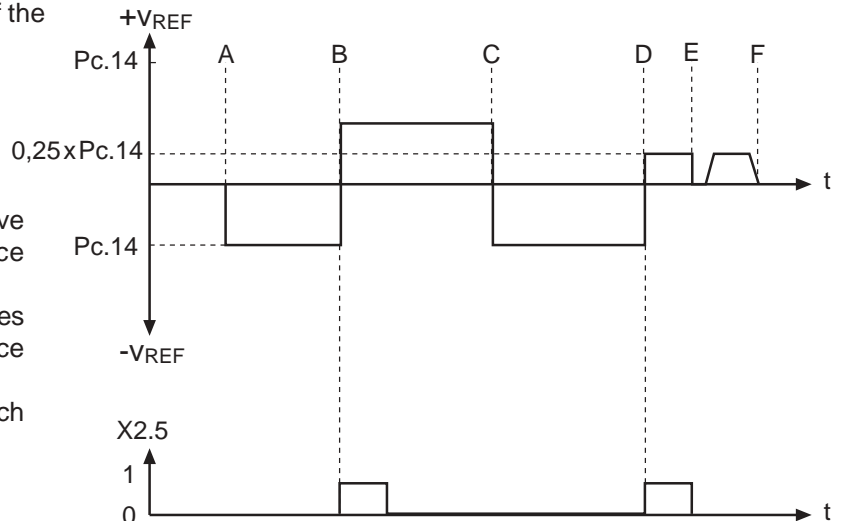
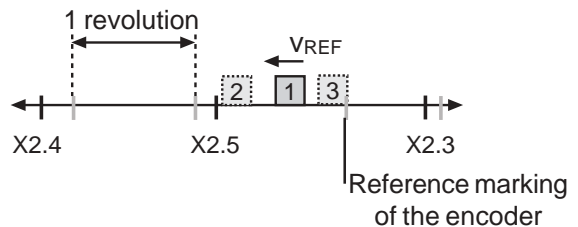

- A: Starting reference point approach
- B: Brought in position at limit switch, drive reverses and search for reference marking of the encoder
- C: Found reference marking, drive reverses once more and search for reference switch
- D: Brought in position at reference switch, drive reverses
- E: Reference switch cleared
- F: Encoder to reference marking

One limit switch serves at the same time as reference point switch; reference point run with approach of reference marking of encoder.

- Terminal X2.3 = limit switch right (di.11 = 16)
- Terminal X2.4 = limit switch left + reference point switch (di.12 = 21)
- Reference speed -100 min^{-1} with counter-clockwise rotation (Pc.14 = -100)
- Starting of reference point approach with X2.7 (di.5 = 10) **or** by bus / PC with parameter Pd.1 = 2 (Pc.10 = 0)

Fig. 6.11.8.d Reference point approach example 2

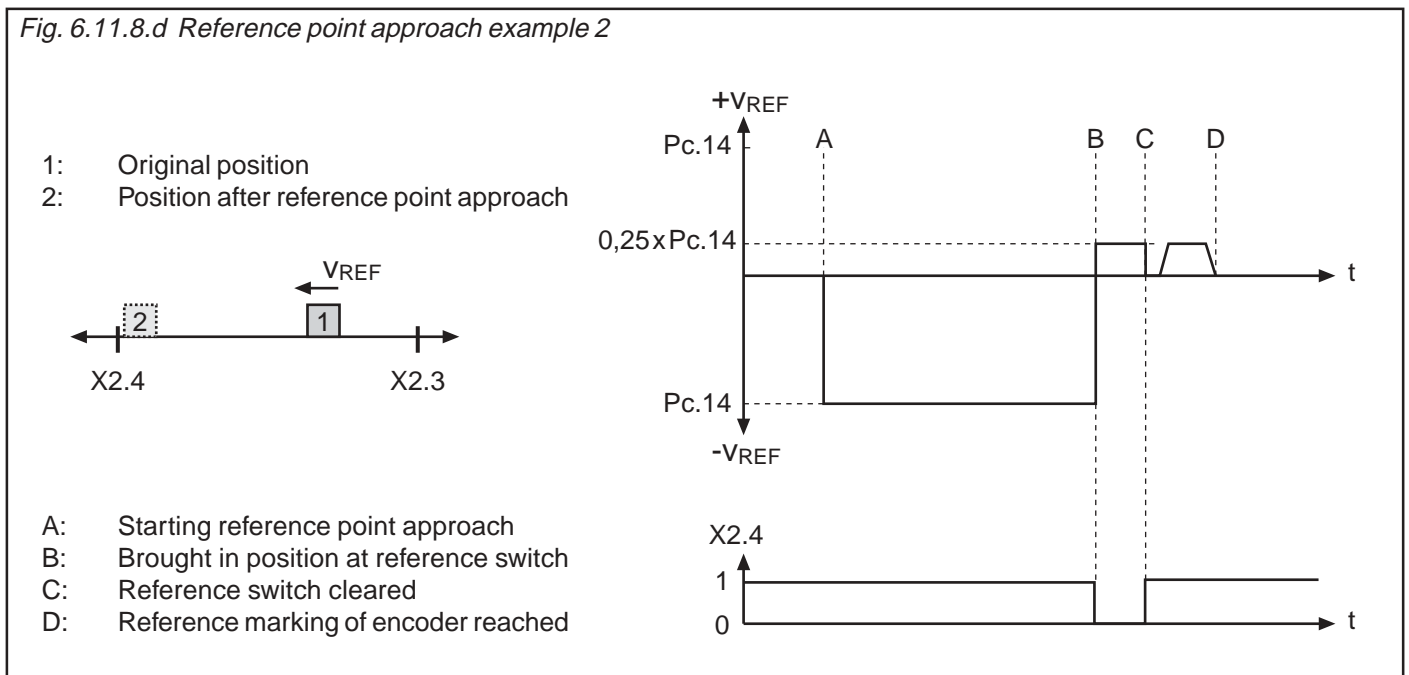

6.11.11 Switching conditions for Posi

Target window (Pd.12)

After carrying out a positioning command, a „position reached“ signal can be set by way of a digital output (see chapter 6.3). This message is given out, when the precontrol profile is finished and the drive is in the target window. This target window is adjustable in Pd.12.

Target window = setpoint position- target window size...setpoint position + target window size

The signal 'Target window reached' is also set, if a positioning was broken off by abort command or if during the current positioning a new target window was preset, that (without change of the rotational direction) could not be reached. The setting of the signal depends on Pd.15 (see following table).

The signal is reset, if a new positioning is started or if the drive goes into the status 'noP', error or malfunction or if the positioning is switched off over a digital input (function 20) or Pd.0.

Target not reached The signal 'Target not reached' is set, if a positioning was aborted and the preset residual distance (Pc.18, Pc.19) is smaller than the distance the controller would still travel upon immediate start of deceleration before it reaches standstill.

'Target not reached' is also set, if during the current positioning a new target position is adjusted, that (without change of the rotational direction) cannot be reached.

Abort active If upon recognized abort-command it is still possible to travel the preset residual distance from the current actual position, the switching condition 'Abort active' is set. The signal is reset, if a new 'Start positioning'-command is recognized or the Posi-mode is deactivated.

Switching conditions in Pd.15

		Pd.15	Target reached	Target not reached
Positioning	standard positioning	XX	set on reaching standstill	not set
	new target position / new target position not reachable	0	set on reaching the new target position	setted, as soon as not reachable target position is entered
		1	set on reaching the old target position	
		2	set on reaching the new target position	
		3	set on reaching the old target position	not set
	new position setting during deceleration ramp	0	set on reaching standstill (= old target position)	setted, as soon as new target position is entered
		1	set on reaching the new target position	
		2	set on reaching the old target position	
		3	set on reaching the new target position	not set
	Abort	Abort / Abort position reachable	XX	set on reaching the abort position
Abort / Abort position not reachable		0	set on reaching standstill	setted, as soon as not reachable abort position is entered
		1	set reaching standstill	
		2	set on reaching the original target position	
		3	set on reaching standstill	
Abort signal setting during deceleration ramp		XX	set on reaching the original target position	setted, as soon as abort signal is entered
Target position nearer than abort position and Pc.36 = 2 or 3	XX	set on reaching the original target position	not set	

6.11.12 Adjustment of Position Controller and Drive Profile

At large mass moments of inertia unwanted effects often occur during positioning; following a short instruction for the parameterizing.

- Carry out the speed controller setting as usual (CS-Par.)
- Activate the positioning module and record the positioning process with the inverter-scope.

The following example was recorded with a COMBIVERT S4, but it also corresponds to a COMBIVERT F4-F:

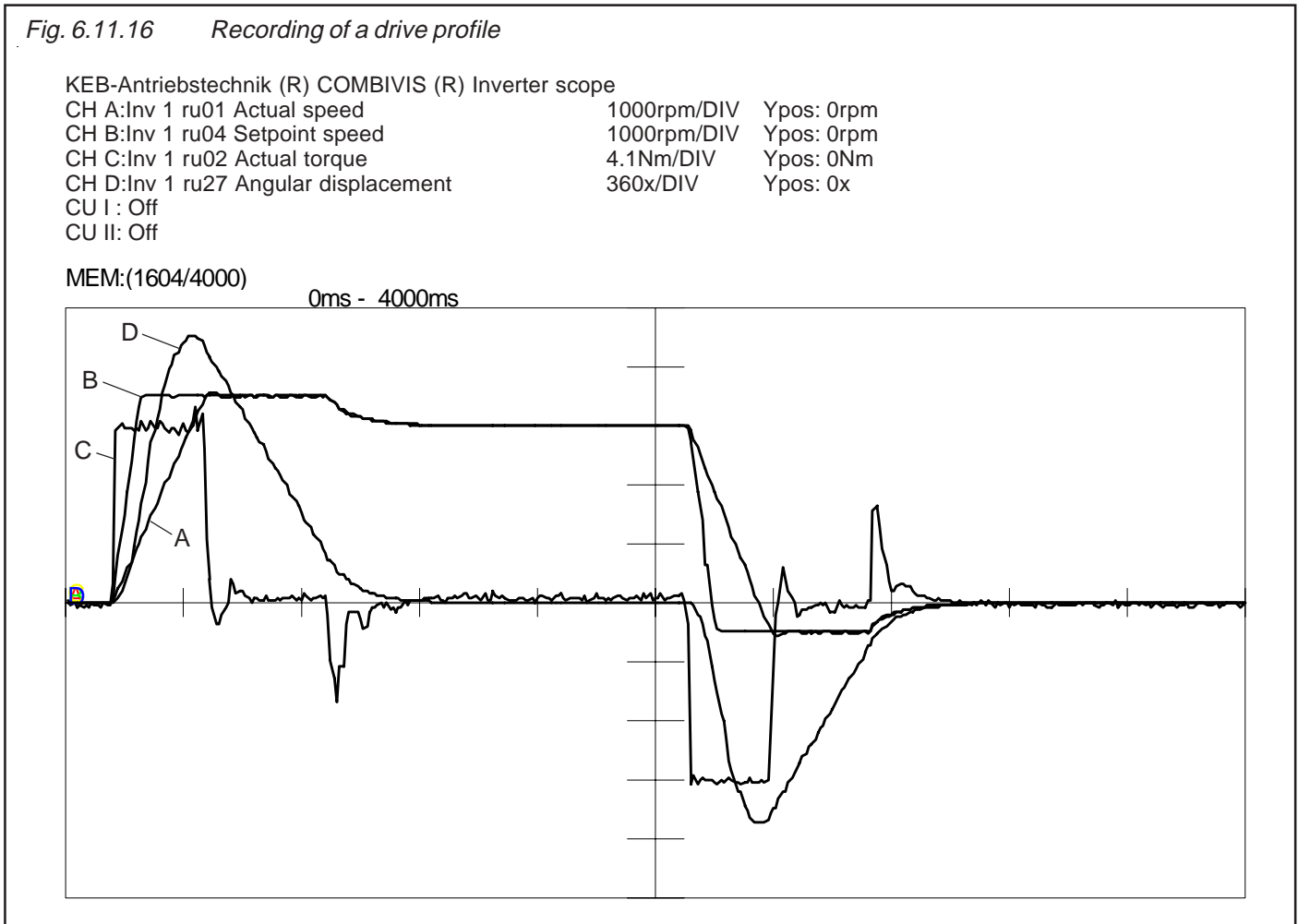

This recording shows that the drive cannot follow the setpoint. At the acceleration along the torque limit the angular displacement increases. The drive compensates the phase-angle error by catching up until zero. At this it is important that the maximum speed (SP.8/SP.9) is adjusted larger than Pd.3 + Pd.7.

During deceleration the drive cannot follow the precontrol profile. It comes to an overshoot. Subsequently the drive is put back into its setpoint position with the speed adjusted in Pd.3. In this example the overshoot (angular displacement) amounts to 3.5 motor revolutions.

To accelerate up to the maximum speed the drive requires approx. 300 ms in this example. For our second test we adjust this value now for as acceleration time Pd.6.

Fig. 6.11.16.a Optimization of the drive profile

KEB-Antriebstechnik (R) COMBIVIS (R) Inverter scope
 CH A:Inv 1 ru01 Actual speed 1000rpm/DIV Ypos: 0rpm
 CH B:Inv 1 ru04 Setpoint speed 1000rpm/DIV Ypos: 0rpm
 CH C:Inv 1 ru02 Actual torque 4.1Nm/DIV Ypos: 0Nm
 CH D:Inv 1 ru27 Angular displacement 360x/DIV Ypos: 0x
 CU I : Off
 CU II: Off

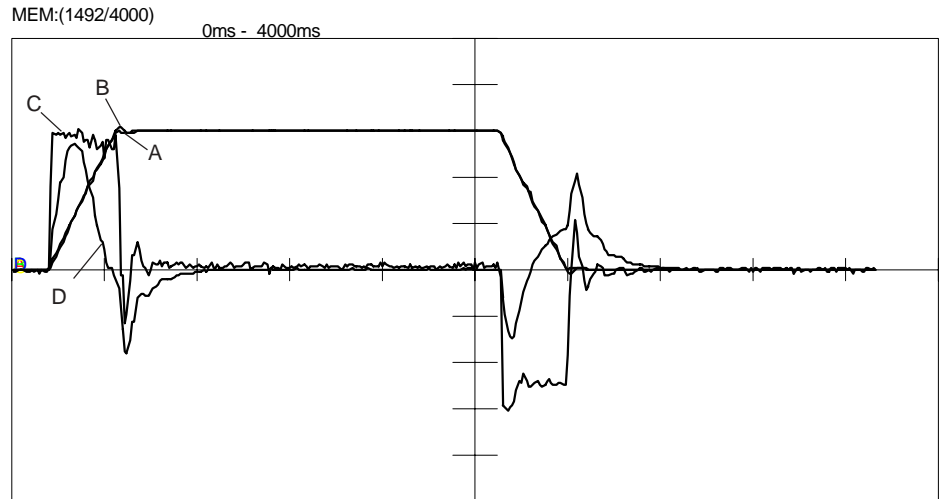

With this setting $Pd.6 = 0,3\text{ s}$ the drive can follow the precontrol profile. Only the corner points of the precontrol profile show torque impulses which can have a disturbing effect on the mechanics of the machine.

Fig. 6.11.16.b Optimization through S-curves

KEB-Antriebstechnik (R) COMBIVIS (R) Inverter scope
 CH A:Inv 1 ru01 Actual speed 1000rpm/DIV Ypos: 0rpm
 CH B:Inv 1 ru04 Setpoint speed 1000rpm/DIV Ypos: 0rpm
 CH C:Inv 1 ru02 Actual torque 4.1Nm/DIV Ypos: 0Nm
 CH D:Inv 1 ru27 Angular displacement 360x/DIV Ypos: 0x
 CU I : Off
 CU II: Off

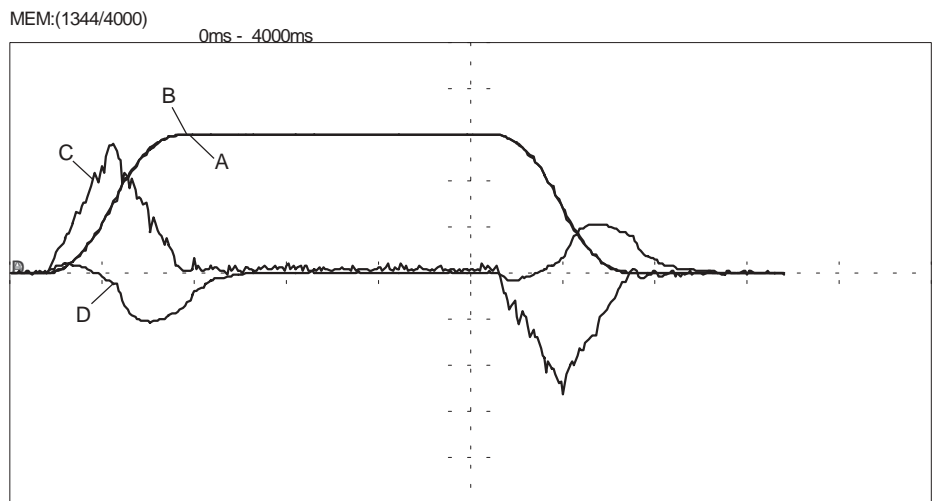

At large mass moments of inertia the use of S-curves is recommended. In the following a test with $Pd.5 = 0,3\text{ s}$ and $Pd.6 = 0.01\text{ s}$.

- Here the drive follows the precontrol profile optimally.
- Setpoint speed and actual speed lie on top of each other.
- The torque has a 'triangular' form.
- The drive has no overshoot in the target window.
- The angular displacement is maximal about 10° .

6.11.13 Check List

1	Positioning module activated	Pc.0 = 1 or 2
2	Select mode of position setting (increments / revolutions)	Pc.1
3	Parameter set selection activated (also possible by bus)	Fr.2 = 1...3 Fr.4
4	Inputs for selection of positions (parameter sets) defined	di.3...di.12 = 1
5	Reference point approach defined or disabled	Pc.10..Pc.14, di.3...di.12
6	Positioning in the individual sets enabled / disabled	Pd.0
7	Setpoint positions and traversing mode defined in the sets	Pd.8...Pd.11
8	Drive profile for the approach of the positions defined	Pd.5...Pd.7
9	Target window defined	Pd.12
10	Software-limit positions adjusted or disabled	Pc.4...Pc.9
11	Hardware-limit switch activated	di.3...di.6, di.11...di.12, Pn.24
12	Starting command for positioning defined	di.3...di.6, di.11...di.12
13	Speed controller and position controller adjusted	CS.0, CS.1, Pd.2, Pd.3
14	If necessary, program digital output (e.g. target window reached)	do.-Par.

6.11.14 Programming Examples

Positioning control with four positions

Requirements:

- four different positions shall be approached by the control
- the addressing of the positions is done by way of terminal strip
- the positioning starts with 'start positioning' - signal
- output D1 shall be set when the target is reached
- after power-on the reference point approach shall be started with 'start positioning'
- the positions are adjusted absolute referring to the reference point (adjustment in increments, position setpoint values = 80500, 1286000, 24000, 163800)
- the absolute positions - 320000 and +1500000 are the limit for the position setpoint value
- the positions are indicated and adjusted in decimal values
- when a digital input is set it shall be possible to handle the drive manually with the analog setpoint value (emergency operation)
- the left limit switch is also the reference switch with turning back to zero position

Sequence:

- the control selects the positioning set
- after that the control gives 'start positioning' (positioning set must still be present at the terminal strip)
- the controller takes the position, speed and controller setting etc. from the selected positioning set
- after reaching the target window and termination of precontrol signal the 'target window reached' signal is set
- only now new set addresses and a new 'start positioning' -command are accepted
- the signal 'target window reached' is reset with the new 'start positioning' -command
- if I4 is activated the controller operates with the analog setpoint value

Positioning - control (Pc) - Parameter			
Pc. 0	Positioning module	1	on
Pc. 1	Adjustment mode	0	position display / -setting in increments
Pc. 4	Limit position left sign	-1	negative position value for limit position left
Pc. 5	Limit position left high	32	limit position left high * 10000 = 320.000 increments
Pc. 6	Limit position left low	0	limit position left low = 0 increments
Pc. 7	Limit position right sign	0	positive position value for limit position right
Pc. 8	Limit position right high	150	limit position right high * 10000 = 1.500.000 increments
Pc. 9	Limit position right low	0	limit position right low = 0 increments
Pc.10	Reference point mode	1	auto ref on
Pc.11	Reference point sign	0	
Pc.12	Reference point high	0	reference point position = zero point
Pc.13	Reference point low	0	
Pc.14	Reference speed	-100	the reference point is searched for with a speed of 100 rpm in rotation direction left / automatic reversal of rotation direction on reaching the limit switch / negative speed, since the reference point lies on the left limit switch

Position setting (Pd) - Parameter						
		Set 0	Set 1	Set 2	Set 3	
Pd. 0	Positioning	1	1	1	1	on
Pd. 1	Manual start	0	0	0	0	no manual starting
Pd. 2	Kp position	20	20	20	20	depending on the load
Pd. 3	Limit for position controller	500	500	500	500	
Pd. 5	S curve time	0,5	0,5	0,5	0,5	
Pd. 6	Acceleration time	0,6	0,6	0,6	0,6	
Pd. 7	Maximum speed	2100	2100	2100	2100	
Pd. 8	Position setting sign	0	0	0	0	
Pd. 9	Position setting high	8	128	2	16	setting see reference point
Pd. 10	Position setting low	500	6000	4000	3800	
Pd. 11	Positioning mode	0	0	0	0	absolute
Pd. 12	Target window size	16383	16383	16383	16383	target window 90°

Digital inputs (di) - Parameter		
di. 3	Input function I1	1 : Set selection
di. 4	Input function I2	1 : Set selection
di. 5	Input function I3	19 : Start positioning
di. 6	Input function I4	22 : Positioning deactivated
di. 11	Input function I5	16 : Limit switch right
di. 12	Input function I6	21 : Limit switch left + reference switch

Digital outputs (do) - Parameter		
do. 1	Switching condition 1	30 : Target window reached
do. 28	Output filter 1 time	20 ms
do. 30	Output filter linkage	1 : D1

Free-to-program parameter (Fr) - Parameter		
Fr. 2	Source parameter set	2 : Terminal strip binary-coded

COMBIVIS Parameter list for programming examples			
*ud01	Bus password	=	440
Fr01	Copy parameter set	=	-2: Copy default set into all sets
di03	Input function I1	=	1: Set selection
di04	Input function I2	=	1: Set selection
di05	Input function I3	=	19: Start Posi
di06	Input function I4	=	22: Posi off
di11	Input function I5	=	16: F
di12	Input function I6	=	21: R + reference switch
Fr02	Source parameter set	=	2: Terminal (binary-code'd)
Pc00	Positioning module	=	1:On
Pc01	Setting mode	=	0: pos.disp. DEZ / pos.input DEZ
Pc04	Limit position left sign	=	0: -
Pc05	Limit position left High	=	32
Pc06	Limit position Low	=	0
Pc07	Limit position right sign	=	0: +
Pc08	Limit position High	=	150
Pc09	Limit position Low	=	0
Pc10	Reference point mode	=	1: auto ref on
Pc14	Reference speed	=	-100.0 rpm
Pd00	Positioning	=	1:on
Pd02	Kp position	=	20
Pd03	Limit for position controller	=	250 UpM
Pd05	S - curve time	=	0.50 s
Pd06	Acceleration time	=	0.60 s
Pd07	Maximum speed	=	3000 rpm
Pd08	Position setting sign	=	0: +
Pd09	Position setting High	=	8
Pd10	Position setting Low	=	500
Pd11	Positioning mode	=	0: absolute
Pd12	Target window size	=	16383
do01	Switching condition 1	=	30: Target window reached
do28	Output filter 1 time	=	20 ms
do30	Linkage output filter 1	=	do01
*Fr09	Bus parameter sez	=	1: Set 1
Fr01	Copy parameter set	=	0: Copy set 0 (stand.) to Fr.09
Pd08	Position setting sign	=	0: +
Pd09	Position setting High	=	128
Pd10	Position setting Low	=	6000
*Fr09	Bus parameter set	=	2: Set 2
Fr01	Copy parameter set	=	0: Copy set 0 (stand.) to Fr.09
Pd08	Position setting sign	=	0: +
Pd09	Position setting High	=	2
Pd10	Position setting Low	=	4000
*Fr09	Bus parameter set	=	3: Set 3
Fr01	Copy parameter set	=	0: Copy set 0 (stand.) to Fr.09
Pd08	Position setting sign	=	0: +
Pd09	Position setting High	=	16
Pd10	Position setting Low	=	3800
*Fr.09	Bus parameter set	=	0: Set 0

Programming of an automatic sequence control

Requirement:

- 7 different positions shall be approached automatically one after the other in a cyclic manner
- to start each new positioning Start Positioning must be given
- the reference point has the absolute value + 100.000 , the limit switches are at position 0 and + 200.000
- the reference point approach is started with a digital input
- from the reference point a setpoint position of :
+ 75000 / - 50.000 / - 50.000 / - 50.000 / -15.000 / + 100.000 / - 10.000 shall be driven
- the relay shall process the 'Target window reached' - signal

Sequence:

- after 'power on' the reference point approach can be started with I2. If the reference switch I3 is active the actual position is overwritten with the reference position and the mode is terminated
- now the positoning in set 1 is started with I1
- with each further positive edge of I1 the next position is approached
- in set 0 the drive returns to its reference position

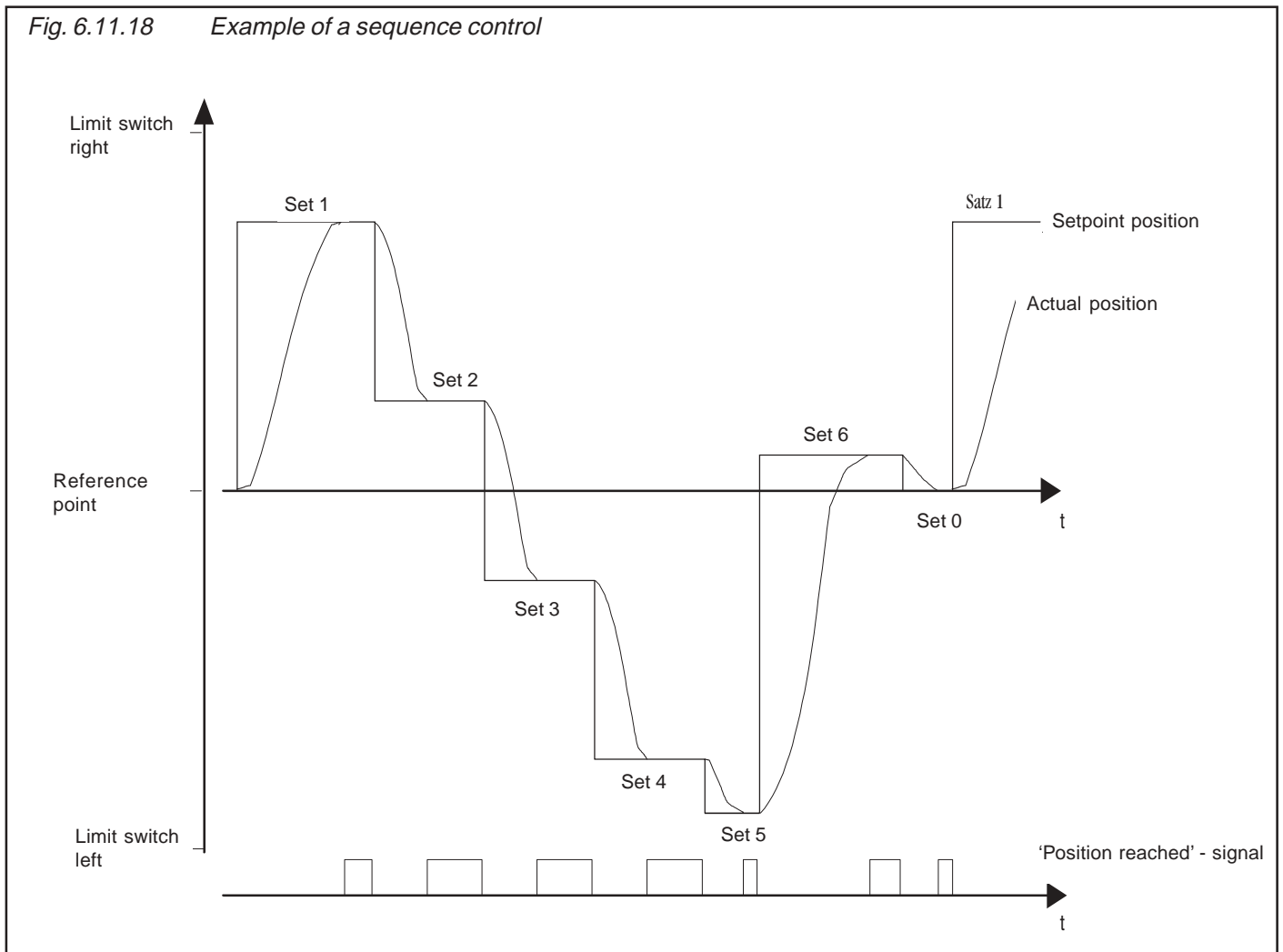

Position setting (Pd) - Parameter

		set 0	1	2	3	4	5	6	
Pd. 0	Positioning	1	1	1	1	1	1	1	on
Pd. 1	Manual start	0	0	0	0	0	0	0	no manual starting
Pd. 2	Kp position	20	20	20	20	20	20	20	
Pd. 3	Limit for position controller	500	500	500	500	500	500	500	
Pd. 5	S curve time	0,1	0,5	0,5	0,5	2	0,5	0,5	
Pd. 6	Acceleration time	0,2	0,8	0,8	0,8	2	0,8	0,8	
Pd. 7	Maximum speed	1000	2000	2200	2200	2200	2200	2200	
Pd. 8	Position setting sign	0 : +	0 : +	1 : -	1 : -	1 : -	1 : -	0 : +	
Pd. 9	Position setting high	10	7	5	5	5	1	10	setting see reference point
Pd. 10	Position setting low	0	5000	0	0	0	5000	0	
Pd. 11	Positioning mode	0	1	1	1	1	1	1	0 : absolute / 1 : relative
Pd. 12	Target window size	16383	16383	16383	16383	16383	16383	16383	target window 90°

Digital inputs (di) - Parameter

di. 3	Input function I1	19 :	Start positioning
di. 4	Input function I2	10 :	Start reference point run
di. 5	Input function I3	12 :	Reference point switch
di. 6	Input function I4	15 :	RST
di. 7	Input function IA	1 :	SET
di. 8	Input function IB	1 :	SET
di. 9	Input function IC	1 :	SET
di. 11	Input function I5	16 :	Limit switch right
di. 12	Input function I6	17 :	Limit switch left
di. 17	Strobe-dependent	1792 :	IA + IB + IC
di. 18	Selection Strobe signal	16 :	I1

Digital outputs (do) - Parameter

do. 3	Switching condition 3	30 :	Position reached						
do. 4	Switching condition 4	1 :	Generally on						
do. 28	Output filter 1 time	4	ms						
do. 30	Output filter 1 linkage	4 :	do.4						
		Satz 0	1	2	3	4	5	6	
do. 13	Selection switch. condition Out A	do.4	0	do.4	0	do.4	0	0	
do. 14	Selection switch. condition Out B	0	do.4	do.4	0	0	do.4	0	
do. 15	Selection switch. condition Out C	0	0	0	do.4	do.4	do.4	0	

Free-to-program parameter (Fr) - Parameter

Fr. 2	Source parameter set	2 :	Terminal binary-coded
-------	----------------------	-----	-----------------------

Display mode of position values in revolution and increments

Internally a position value exists as a 32-Bit-number. The standardization is selected in such a way that 65536 correspond to one revolution of the position encoder. (Depending on the parameterizing of Pc.16 Encoder 1 or Encoder 2.)

At the representation **in revolutions** the indication takes place in sign-affected 32-Bit numbers. The sign parameter is without function in this mode

Max. value range: 8000.0000_{Hex.} ... 7FFF.FFFF_{Hex.}
 (= > -2.147.483.648_{Dec.} ... 2.147.483.647_{Dec.})

At the representation in increments the sign is given out in one parameter, the 'high'-part of the parameter contains the increments * 10000 and the 'low'- part contains the increments * 1.

Max. value range: -655.359.999_{Dec.} ... 655.359.999_{Dec.}

! With respect to the setting in revolutions larger values can be adjusted than at the setting in increments. When changing between decimal and hexadecimal display/ setting the value ranges must be observed !!! Hexadecimal values that lie outside the decimal range are kept but result in misleading displays.

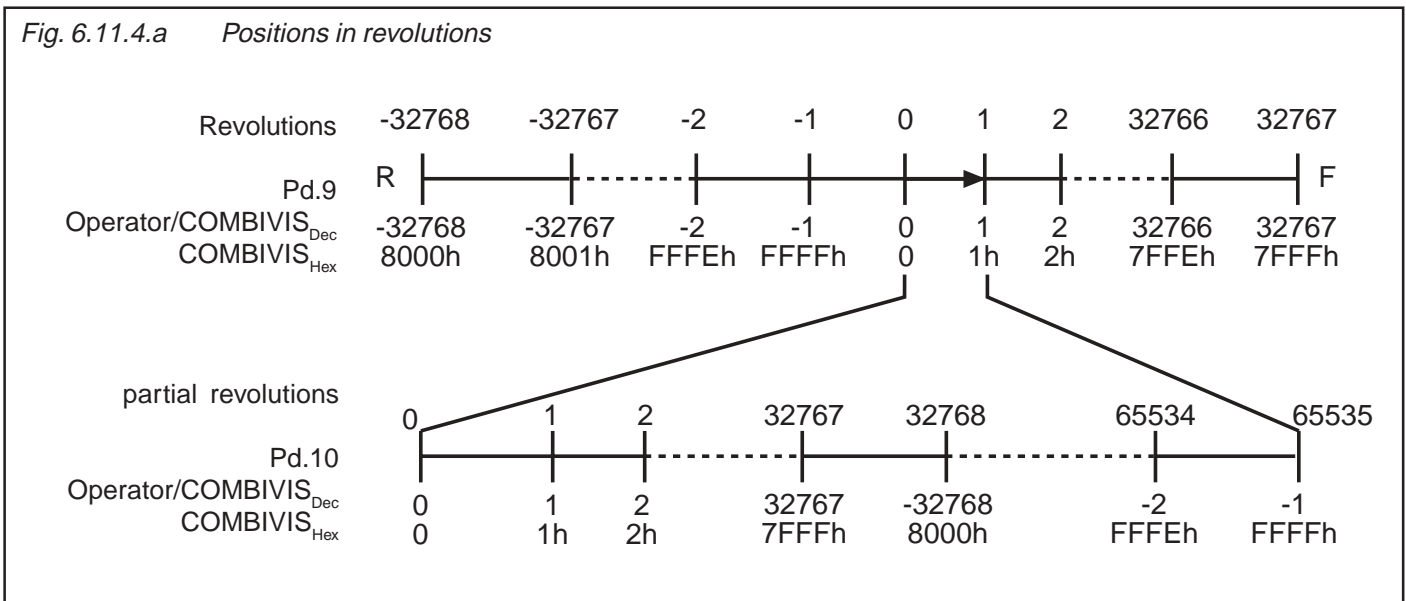

To change between decimal and hexadecimal representation in COMBIVIS press key <F4>.



The conversion of decimal numbers into hexadecimal numbers can be done with a suitable calculator. Computers with Windows operating system already provide such a calculator.



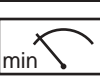

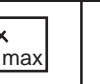

Fig. 6.11.5 Positions in increments

Pd.8 (counter-clockwise) reverse = (-0 (+) = forward (clockwise)

Increments x 10000	0	1	10	32767	32768	65535	Ink x 10000
Pd.9	----- ----- ----- ----- ----- -----						
Operator/COMBIVIS _{DEZ}	0	1	10	32767	-32768	-1	
COMBIVIS _{HEX}	0h	1h	Ah	7FFFh	8000h	FFFFh	

Increments x 1	0	1	10			9999	Ink x 1
Pd.10	----- ----- ----- ----- ----- -----						
Operator/COMBIVIS _{DEZ}	0	1	10			9999	
COMBIVIS _{HEX}	0h	1h	Ah			270Fh	

6.11.15 Used Parameters

Param.	Adr.								
Pc.0	3600h	✓	-	✓	0	1	1	0	-
Pc.1	3601h	✓	-	✓	0	3	1	3	-
Pc.4	3604h	✓	-	-	0	1	1	2	-
Pc.5	3605h	✓	-	-	0 inc	65535 inc	1 inc	8000h inc	-
Pc.6	3606h	✓	-	-	0 inc	65535 inc	1 inc	0 inc	-
Pc.7	3607h	✓	-	-	0	1	1	2	-
Pc.8	3608h	✓	-	-	0 inc	65535 inc	1 inc	7FFFh inc	-
Pc.9	3609h	✓	-	-	0 inc	65535 inc	1 inc	FFFFh inc	-
Pc.10	360Ah	✓	-	✓	0	5	1	0	-
Pc.11	360Bh	✓	-	-	0	1	1	0	-
Pc.12	360Ch	✓	-	-	0	65535	1	0	-
Pc.13	360Dh	✓	-	-	0	65535	1	0	-
Pc.14	360Eh	✓	-	-	-3000,0 rpm	3000,0 rpm	0,5 rpm	100,0 rpm	-
Pc.16	3610h	✓	-	✓	0	1	1	1	-
Pc.17	3611h	✓	-	✓	1,00	250,00	0,01	1,00	-
Pc.18	3612h	-	-	-	0 inc.	32767 inc.	1 inc.	0	-
Pc.19	3613h	-	-	-	0 inc.	65535 inc.	1 inc.	0	-
Pc.33	3621h	-	-	-	0 inc.	32767 inc.	1 inc.	0	-
Pc.34	3622h	-	-	-	0 inc.	65535 inc.	1 inc.	0	-
Pc.35	3623h	-	-	-	0	2	1	0	-
Pc.36	3624h	-	-	-	0	3	1	0	-
Pd.0	3700h	✓	✓	-	0	2	1	0	-
Pd.1	3701h	✓	-	✓	0	4	1	0	-
Pd.2	3702h	✓	✓	-	0	65535	1	30	-
Pd.3	3703h	✓	✓	-	0,0 rpm	500,0 rpm	0,5 rpm	250,0 rpm	-
Pd.5	3705h	✓	✓	-	0,01 s	8,00 s	0,01 s	0,10 s	-
Pd.6	3706h	✓	✓	-	0,01 s	8,00 s	0,01 s	1,0 s	-
Pd.7	3707h	✓	✓	-	0 rpm	10000 rpm	1 rpm	1000 rpm	-
Pd.8	3708h	✓	✓	-	0	1	1	0	-
Pd.9	3709h	✓	✓	-	0 inc	65535 inc	1 inc	0 inc	-
Pd.10	370Ah	✓	✓	-	0 inc	65535 inc	1 inc	0 inc	-
Pd.11	370Bh	✓	✓	-	0	1	1	0	-
Pd.12	370Ch	✓	✓	-	0 inc	65535 inc	1 inc	1000 inc	-

1. Introduction

2. Summary

3. Hardware

4. Operation

5. Parameter

6. Functions

7. Start-up

8. Special Operation

9. Error Assistance

10. Project Planning

11. Networks

12. Applications

13. Annex

6.1 Operating and Unit Data

6.2 Analog In- and Outputs

6.3 Digital In- and Outputs

6.4 Set Value and Ramp Adjustment

6.5 Motor Data and Controller Adjustment

6.6 Keep on Running Functions

6.7 Parameter Sets

6.8 Special Functions

6.9 Encoder Interface

6.10 Synchronous Control

6.11 Positioning Module

6.12 CP-Parameter Definition

6.12.1	Survey	3
6.12.2	Assignment of CP-Parameter	4
6.12.3	Start Parameters	4
6.12.4	Example	5
6.12.5	Used Parameters	5

6.12 CP-Parameter Definition

Once the development stage of a machine is completed only a few parameters are usually needed for the adjustment or the control of the inverter. To simplify the handling and the user documentation and to improve the safety of operation by eliminating unauthorized access, the possibility exists to create the own operator interface - the CP-parameters. For that purpose 36 parameters (CP.0...CP.36) are available and 35 of them (CP.1...CP.36) are free to assign.

6.12.1 Survey

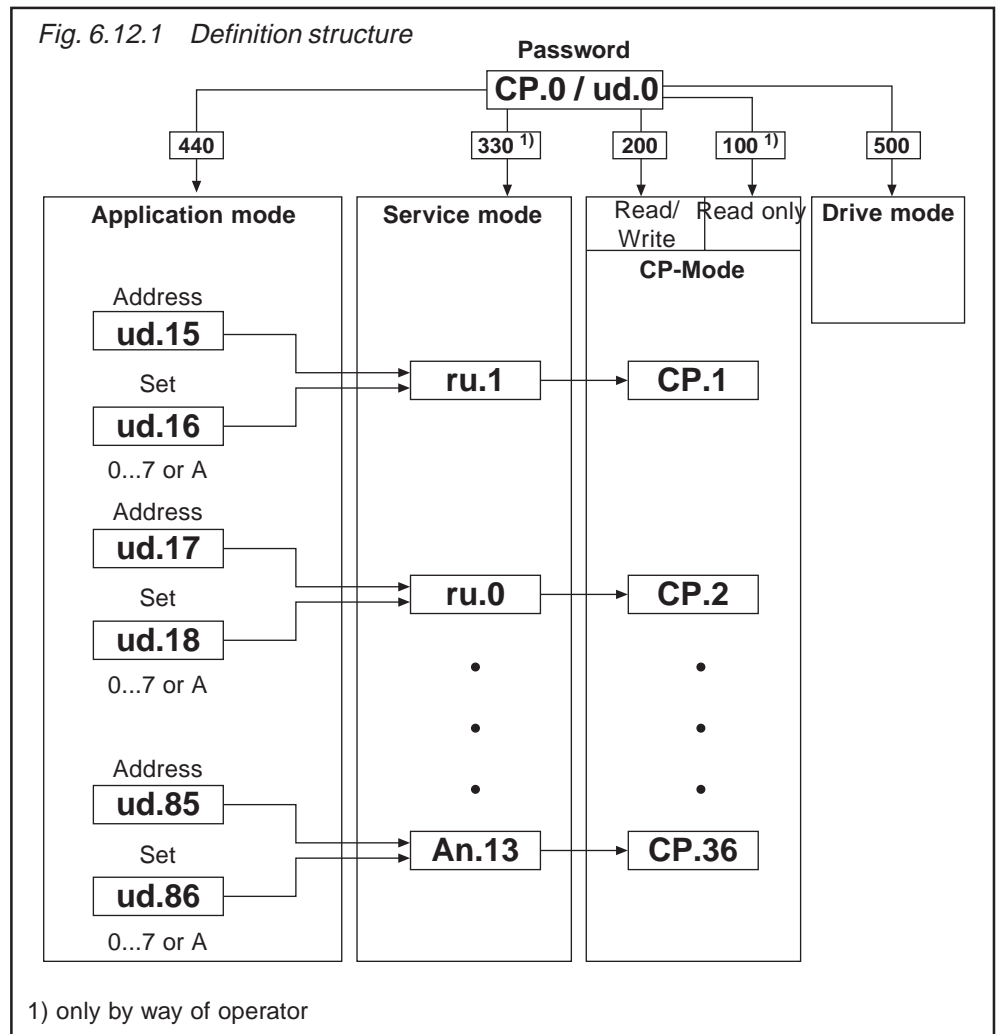

With two ud-parameters the parameter to be displayed is defined by its address and the respective set. Depending on the adjusted password (CP.0 or ud.0)

- the adjusted parameter is displayed directly in the service-mode
- the adjusted parameter is displayed in the CP-mode as CP-parameter

Parameter CP.0 is nonprogrammable and always contains the password input. If the inverter is in the application or the service-mode ud.0 is used for the password input. The parameters ud.15 up to ud.62 as well as Fr.0 and Fr.1 are not permissible as CP-parameters and are therefore acknowledged as invalid address. When entering an invalid parameter address the parameter is set to „oFF“ (-1). The corresponding CP-parameter is not represented at this setting.

6.12.2 Assignment of CP-Parameter

The following list shows the assignment of the ud-parameters to the CP-parameters. The first parameter defines the parameter address (see Chapter 5) of the parameter to be displayed, the second parameter defines the parameter set in which the values shall be displayed / changed. Adjustable as parameter set is set 0...7 or the active set (A). At „active set“ the parameter set number is additionally displayed in the 1. digit of the display, to show which set is actually edited.

ud.15 = CP.1 ud.16 = CP.1	ud.39 = CP.13 ud.40 = CP.13	ud.63 = CP.25 ud.64 = CP.25
ud.17 = CP.2 ud.18 = CP.2	ud.41 = CP.14 ud.42 = CP.14	ud.65 = CP.26 ud.66 = CP.26
ud.19 = CP.3 ud.20 = CP.3	ud.43 = CP.15 ud.44 = CP.15	ud.67 = CP.27 ud.68 = CP.27
ud.21 = CP.4 ud.22 = CP.4	ud.45 = CP.16 ud.46 = CP.16	ud.69 = CP.28 ud.70 = CP.28
ud.23 = CP.5 ud.24 = CP.5	ud.47 = CP.17 ud.48 = CP.17	ud.71 = CP.29 ud.72 = CP.29
ud.25 = CP.6 ud.26 = CP.6	ud.49 = CP.18 ud.50 = CP.18	ud.73 = CP.30 ud.74 = CP.30
ud.27 = CP.7 ud.28 = CP.7	ud.51 = CP.19 ud.52 = CP.19	ud.75 = CP.31 ud.76 = CP.31
ud.29 = CP.8 ud.30 = CP.8	ud.53 = CP.20 ud.54 = CP.20	ud.77 = CP.32 ud.78 = CP.32
ud.31 = CP.9 ud.32 = CP.9	ud.55 = CP.21 ud.56 = CP.21	ud.79 = CP.33 ud.80 = CP.33
ud.33 = CP.10 ud.34 = CP.10	ud.57 = CP.22 ud.58 = CP.22	ud.81 = CP.34 ud.82 = CP.34
ud.35 = CP.11 ud.36 = CP.11	ud.59 = CP.23 ud.60 = CP.23	ud.83 = CP.35 ud.84 = CP.35
ud.37 = CP.12 ud.38 = CP.12	ud.61 = CP.24 ud.62 = CP.24	ud.85 = CP.36 ud.86 = CP.36

6.12.3 Start Parameter (ud.2, ud.3)

The parameter, that is to be displayed after switch-on of the inverter, is selected with the parameter „Start parameter group“ (ud.2) and „Start parameter number“ (ud.3). For that the desired parameter group is adjusted in ud.2 and the desired parameter number is adjusted in ud.3. The parameter set is always set 0. If the combination of ud.2 and ud.3 results in a parameter that does not exist, or if the password level provided at switch-on is not sufficient to display the parameter, then the inverter starts with the display of ru.0.

If a password level < 3 is active at switch-on, i.e. display of the user-defined parameter groups, then the adjustment of ud.2 is ignored, in that case ud.3 indicates the parameter number of the CP-parameter, whose value shall be displayed at the start. If this parameter does not exist, then CP.0 is indicated.

6.12.4 Example







For example a user menu shall be programmed with following characteristics:

1. Display of actual frequency (ru.1) in the respective set
2. Absolute digital setpoint setting (SP. 1) in set 2
3. Absolute digital setpoint setting (SP. 1) in set 3
4. Acceleration and deceleration time (SP.11/SP.12) in the respective active set
5. On switch on the active parameter set (ru.18) shall be displayed

- 1.) ud.15 = 2001 ; Parameter address for ru.1
ud.16 = A ; Display in the active set
- 2.) ud.17 = 3001 ; Parameter address for SP. 1
ud.18 = 2 ; Preadjustment in set 2
- 3.) ud.19 = 3001 ; Parameter address for SP. 1
ud.20 = 3 ; Preadjustment in set 3
- 4.) ud.21 = 300B ; Parameter address for SP.11
ud.22 = A ; Preadjustment in the respective set active at the time
ud.23 = 300C ; Parameter address for SP.12
ud.24 = A ; Preadjustment in the respective set active at the time
- 5.) ud.27 = 2012 ; Parameter address for ru.18
ud.28 = A ; Display in the active set
ud.2 = 1 ; Display of ru-Parameter (by activating the CP-mode this
; this setting is ignored)
ud.3 = 7 ; Display of CP.7
adjust all other parameter addresses to „off“ so that no indication occurs.

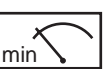
6.12.5 Used Parameters

Param.	Adr.	R/W	PROG.	ENTER	min	max	Step	default	
ud.0	2600h	✓	-	✓	0	9999	1	cp_on	-
ud.1	2601h	✓	-	-	-32767	32767	1	cp_on	only visible by bus
ud.2	2602h	✓	-	-	1(ru)	16(Pd)	1	1 (ru)	ru/SP/Pn/dr/cs/ds/ud/Fr/An/di/do/LE/In/Sn/Pc/PdAA
ud.3	2603h	✓	-	-	0	*255	*1	1	* dependent on parameter group
ud.13	260Dh	-	-	-	-	-	-	-	only visible by bus
ud.14	260Eh	-	-	-	-	-	-	-	only visible by bus
ud.15	260Fh	✓	-	✓	-1 (off)	7FFF	1	2001	corresponds to ru.1
ud.16	2610h	✓	-	✓	0	8	1	0	set 0...7; A(8) = active set

Param.	Adr.	 R/W	 PROG.	 ENTER	 min	 max	 Step	 default	
ud.17	2611h	✓	-	✓	0	7FFF	1	2000	corresponds to ru.0
ud.18	2612h	✓	-	✓	0	8	1	0	set 0...7; A(8) = active set
ud.19	2613h	✓	-	✓	0	7FFF	1	2009	corresponds to ru.9
ud.20	2614h	✓	-	✓	0	8	1	0	set 0...7; A(8) = active set
ud.21	2615h	✓	-	✓	0	7FFF	1	2019	corresponds to ru.25
ud.22	2616h	✓	-	✓	0	8	1	0	set 0...7; A(8) = active set
ud.23	2617h	✓	-	✓	0	7FFF	1	2002	corresponds to ru.2
ud.24	2618h	✓	-	✓	0	8	1	0	set 0...7; A(8) = active set
ud.25	2619h	✓	-	✓	0	7FFF	1	2004	corresponds to ru.4
ud.26	261Ah	✓	-	✓	0	8	1	0	set 0...7; A(8) = active set
ud.27	261Bh	✓	-	✓	0	7FFF	1	300B	corresponds to SP.11
ud.28	261Ch	✓	-	✓	0	8	1	0	set 0...7; A(8) = active set
ud.29	261Dh	✓	-	✓	0	7FFF	1	300C	corresponds to SP.12
ud.30	261Eh	✓	-	✓	0	8	1	0	set 0...7; A(8) = active set
ud.31	261Fh	✓	-	✓	0	7FFF	1	2D06	corresponds to cs.6
ud.32	2620h	✓	-	✓	0	8	1	0	set 0...7; A(8) = active set
ud.33	2621h	✓	-	✓	0	7FFF	1	3005	corresponds to SP.5
ud.34	2622h	✓	-	✓	0	8	1	0	set 0...7; A(8) = active set
ud.35	2623h	✓	-	✓	0	7FFF	1	3016	corresponds to SP.22
ud.36	2624h	✓	-	✓	0	8	1	0	set 0...7; A(8) = active set
ud.37	2625h	✓	-	✓	0	7FFF	1	2D00	corresponds to cs.0
ud.38	2626h	✓	-	✓	0	8	1	0	set 0...7; A(8) = active set
ud.39	2627h	✓	-	✓	0	7FFF	1	2D01	corresponds to cs.1
ud.40	2628h	✓	-	✓	0	8	1	0	set 0...7; A(8) = active set
ud.41	2629h	✓	-	✓	0	7FFF	1	2419	corresponds to dr.25
ud.42	262Ah	✓	-	✓	0	8	1	0	set 0...7; A(8) = active set
ud.43	262Bh	✓	-	✓	0	7FFF	1	2214	corresponds to Pn.20
ud.44	262Ch	✓	-	✓	0	8	1	0	set 0...7; A(8) = active set
ud.45	262Dh	✓	-	✓	0	7FFF	1	2804	corresponds to An.4
ud.46	262Eh	✓	-	✓	0	8	1	0	set 0...7; A(8) = active set
ud.47	262Fh	✓	-	✓	0	7FFF	1	2802	corresponds to An.2
ud.48	2630h	✓	-	✓	0	8	1	0	set 0...7; A(8) = active set
ud.49	2631h	✓	-	✓	0	7FFF	1	280E	corresponds to An.14
ud.50	2632h	✓	-	✓	0	8	1	0	set 0...7; A(8) = active set
ud.51	2633h	✓	-	✓	0	7FFF	1	280F	corresponds to An.15

Param.	Adr.								
ud.52	2634h	✓	-	✓	0	8	1	0	Set 0...7; A(8) = active set
ud.53	2635h	✓	-	✓	0	7FFF	1	2813	corresponds to An.19
ud.54	2636h	✓	-	✓	0	8	1	0	set 0...7; A(8) = active set
ud.55	2637h	✓	-	✓	0	7FFF	1	2A01	corresponds to do.1
ud.56	2638h	✓	-	✓	0	8	1	0	set 0...7; A(8) = active set
ud.57	2639h	✓	-	✓	0	7FFF	1	2A02	corresponds to do.2
ud.58	263Ah	✓	-	✓	0	8	1	0	set 0...7; A(8) = active set
ud.59	263Bh	✓	-	✓	0	7FFF	1	2B14	corresponds to LE.20
ud.60	263Ch	✓	-	✓	0	8	1	0	set 0...7; A(8) = active set
ud.61	263Dh	✓	-	✓	0	7FFF	1	2B05	corresponds to LE.5
ud.62	263Eh	✓	-	✓	0	8	1	0	set 0...7; A(8) = active set
ud.63	264Fh	✓	-	✓	0	7FFF	1	2400	corresponds to dr.0
ud.64	2640h	✓	-	✓	0	8	1	0	set 0...7; A(8) = active set
ud.65	2641h	✓	-	✓	0	7FFF	1	2401	corresponds to dr.1
ud.66	2642h	✓	-	✓	0	8	1	0	set 0...7; A(8) = active set
ud.67	2643h	✓	-	✓	0	7FFF	1	2402	corresponds to dr.2
ud.68	2644h	✓	-	✓	0	8	1	0	set 0...7; A(8) = active set
ud.69	2645h	✓	-	✓	0	7FFF	1	2403	corresponds to dr.3
ud.70	2646h	✓	-	✓	0	8	1	0	set 0...7; A(8) = active set
ud.71	2647h	✓	-	✓	0	7FFF	1	2404	corresponds to dr.4
ud.72	2648h	✓	-	✓	0	8	1	0	set 0...7; A(8) = active set
ud.73	2649h	✓	-	✓	0	7FFF	1	240C	corresponds to dr.12
ud.74	264Ah	✓	-	✓	0	8	1	0	set 0...7; A(8) = active set
ud.75	264Bh	✓	-	✓	0	7FFF	1	270A	corresponds to Fr.10
ud.76	264Ch	✓	-	✓	0	8	1	0	set 0...7; A(8) = active set
ud.77	264Dh	✓	-	✓	0	7FFF	1	2D17	corresponds to CS.23
ud.78	264Eh	✓	-	✓	0	8	1	0	set 0...7; A(8) = active set
ud.79	264Fh	✓	-	✓	0	7FFF	1	2F0B	corresponds to ds.11
ud.80	2650h	✓	-	✓	0	8	1	0	set 0...7; A(8) = active set
ud.81	2651h	✓	-	✓	0	7FFF	1	241D	corresponds to dr.29
ud.82	2652h	✓	-	✓	0	8	1	0	set 0...7; A(8) = active set
ud.83	2653h	✓	-	✓	0	7FFF	1	2218	corresponds to Pn.24
ud.84	2654h	✓	-	✓	0	8	1	0	set 0...7; A(8) = active set
ud.85	2655h	✓	-	✓	0	7FFF	1	280D	corresponds to An.13
ud.86	2656h	✓	-	✓	0	8	1	0	set 0...7; A(8) = active set

Chapter 6	Section 12	Page 8	Date 18.12.02	Name: Basis KEB COMBIVERT F4-F	© KEB Antriebstechnik, 2002 All Rights reserved
---------------------	----------------------	------------------	------------------	--	--

1. Introduction

2. Summary

3. Hardware

4. Operation

5. Parameter

6. Functions

7. Start-up

8. Special Operation

9. Error Assistance

10. Project Planning

11. Networks

12. Applications

13. Annex

7.1 Preparatory Measures

7.2 Initial Start-up

7.1.1 After uncasing the Goods 3

7.1.2 Installation and Connection 3

7.1.3 Checklist prior to Start-up 4

Chapter 7	Section 1	Page 2	Date 18.12.02	Name: Basis KEB COMBIVERT F4-F	© KEB Antriebstechnik, 2002 All Rights reserved
---------------------	---------------------	------------------	------------------	--	--

7. Start-up

7.1 Preparatory Measures

7.1.1 After unpacking the Goods

The following chapter is intended for everybody who has no experience with the KEB frequency inverters. It shall allow a correct entering into this field. But because of the complex application possibilities we must restrict ourselves to explaining the start-up of standard applications.

After unpacking the goods and checking them for complete delivery following measures are to be carried out:

- Visual control for transport damage
- Insert operator, if ordered

Picture 7.1.1 Insertion of operator (example based on D-housing)

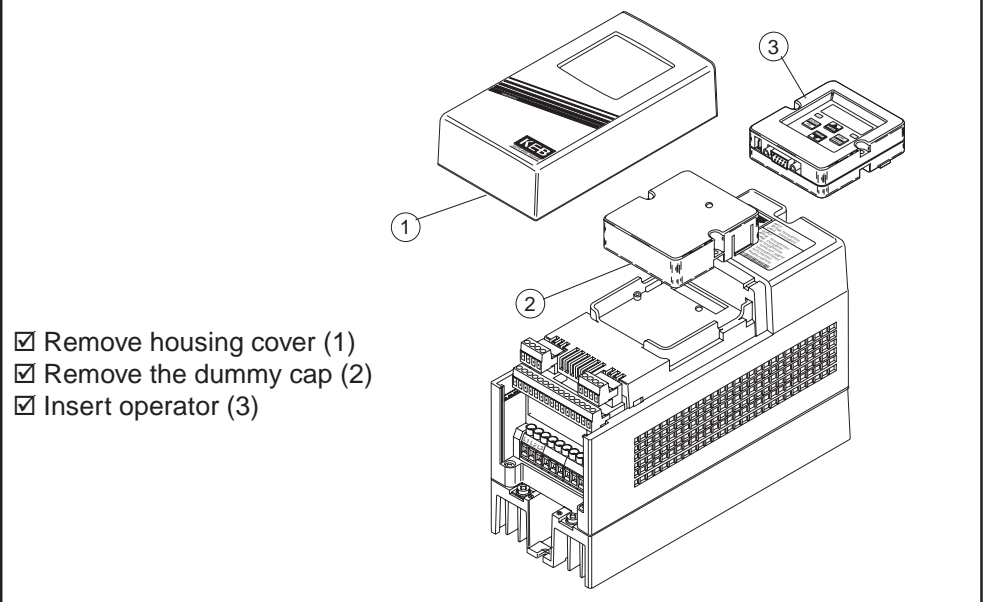

7.1.2 Installation and Connection

The EMC-conform installation of the inverter is described in the Instruction Manual Part 1. Installation and connection instructions are found in the Instruction Manual Part 2.

Picture 7.1.2.a Installation and connection

- The mounting surface of the inverter must be bright.
- If necessary, use contact lacquer as protection against corrosion.
- Connect the earthing strip to central point in the control cabinet.

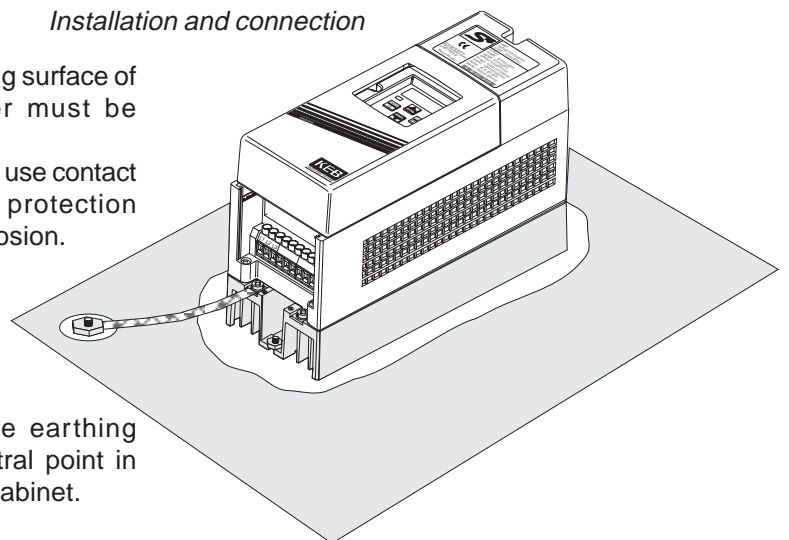

7.1.3 Checklist prior to Start-up

Before switching on the inverter go through the following checklist.

- Is the inverter firmly bolted in the control cabinet?
- Is there enough space to ensure sufficient air circulation?
- Are mains and motor cables as well as the control cables installed separately from each other?
- Are the inverters connected to the correct supply voltage?
- Are all mass and earthing cables attached and well contacted?
- Ensure that mains and motor cables are not interchanged as that will lead to the destruction of the inverter!
- Is the motor connected in-phase?
- Check tacho, initiator and encoder for firm attachment and correct connection!
- Check, whether all power and control cables are firmly in place!
- Remove any tools from the control cabinet!
- Attach all covers and protective caps to ensure that all live parts are secured against direct contact.
- When using measuring instruments or computers an isolating transformer should be used, if not, make sure that the equipotential bonding between the supply lines is guaranteed!
- Open the control release of the inverter to avoid the unintended starting of the machine.

1. Introduction

2. Summary

3. Hardware

4. Operation

5. Parameter

6. Functions

7. Start-up

8. Special Operation

9. Error Assistance

10. Project Planning

11. Networks

12. Applications

13. Annex

7.1 Preparatory Measures

7.2 Initial Start-up

7.2.1 Start-up (controlled) 3

7.2.2 Start-up (closed-loop) 4

Chapter 7	Section 2	Page 2	Date 18.12.02	Name: Basis KEB COMBIVERT F4-F	© KEB Antriebstechnik, 2002 All Rights reserved
---------------------	---------------------	------------------	------------------	--	--

7.2 Initial Start-up

After all initial measures are done the KEB COMBIVERT F4 can be switched on.

7.2.1 Start-up (controlled)

For the controlled initial start-up of KEB COMBIVERT F4-F do the following:

1. Switch off control release (term. X2.1) ⇒ Inverter in status „noP“
2. Select controlled operation ⇒ Parameter CS.23
3. Enter motor data ⇒ Parameter dr.0...dr.4 + dr.12
4. Activate motor data ⇒ Parameter Fr.10
5. Enter necessary boost ⇒ Parameter dS.11
6. Enter encoder (inc/r) ⇒ Parameter dr.25
7. Not cut-off frequency of the encoder and interface ⇒ $f_{limit} > \text{increments} * n_{max} / 60 \text{ Hz}$
e.g. encoder (inc/r): 2500
max. set speed: 3000
 $f_{limit} > 125 \text{ kHz}$
8. Start controlled operation ⇒ see diagram

Picture 7.2.1 Initial start-up (controlled)

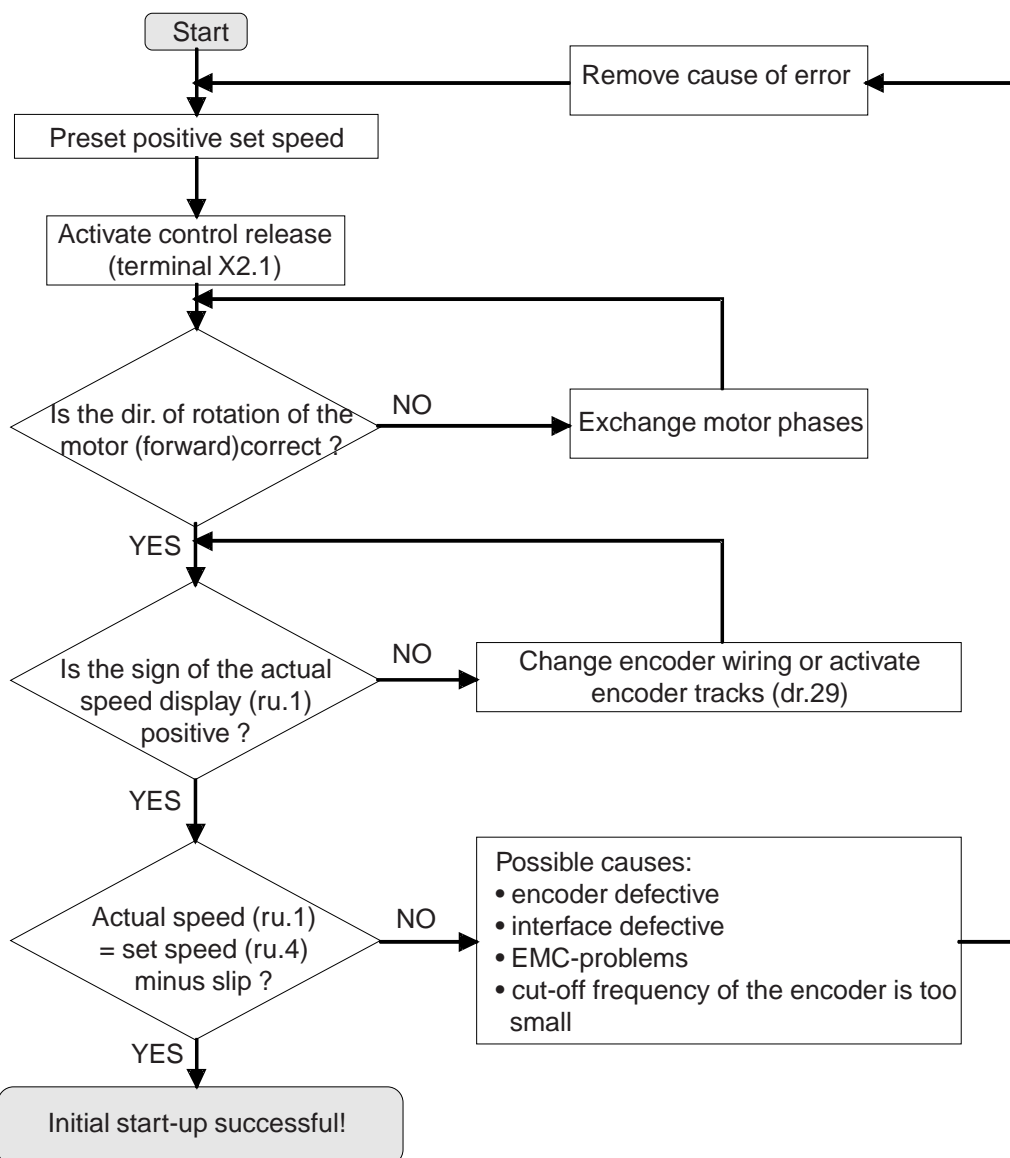

7.2.2 Start-up (closed-loop)

After initial start-up the following adjustments must be done:

1. Switch off control release (terminal X2.1) ⇒ Inverter in status „noP“
2. Select closed-loop operation ⇒ Parameter CS.23
3. Adjust speed controller ⇒ see adjustment tips below

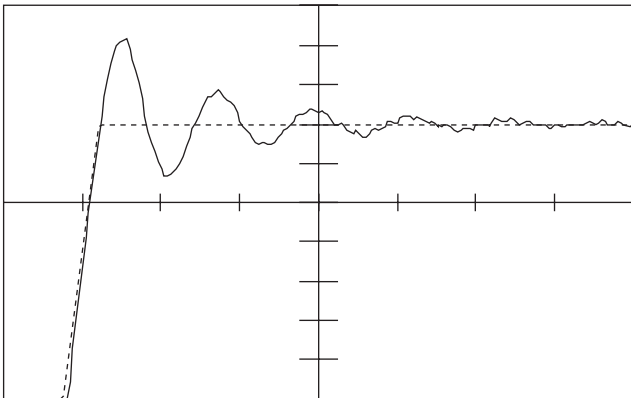

Problem: Very long transient process, but stabilization during constant run

Solution: Increase P-fraction (CS.00); eventually reduce I-fraction (CS.01)

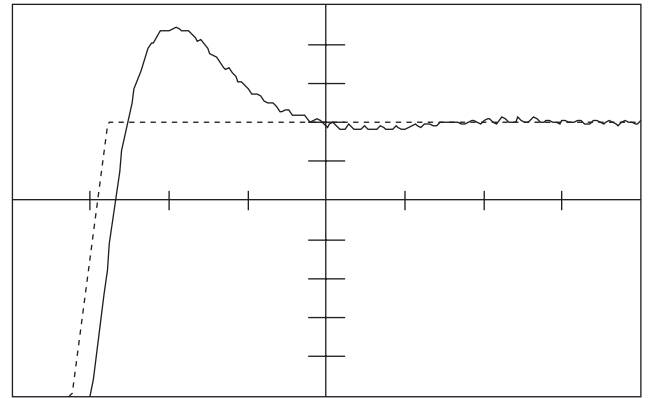

Problem: Speed overshoot too high

Solution: Increase P-fraction (CS.00); eventually reduce I-fraction (CS.01)

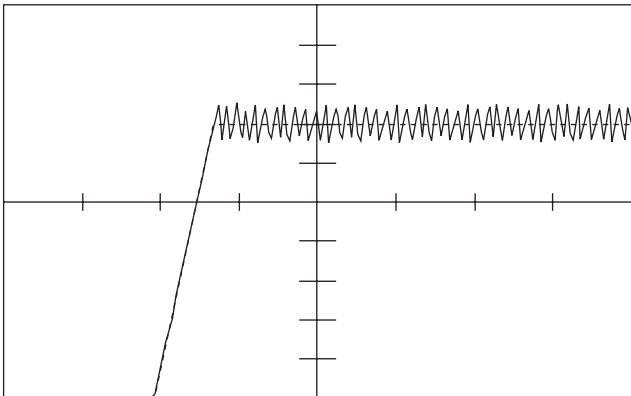

Problem: Sustained oscillation during constant run

Solution: Decrease P-fraction (CS.00)

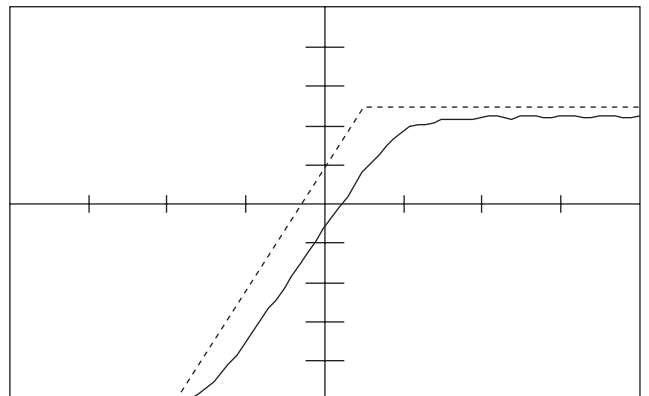

Problem: Transient too slow / remaining system deviation

Solution: Increase I-fraction (CS.01)

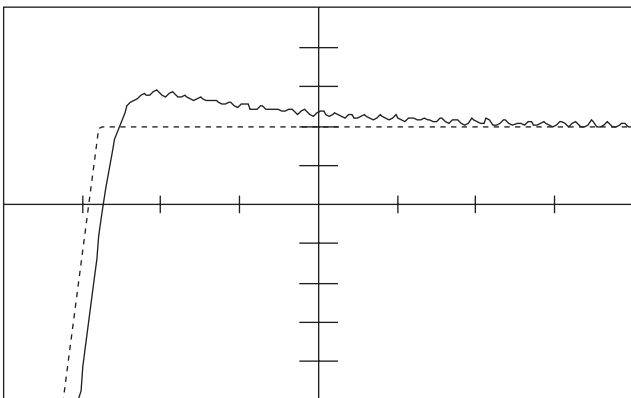

Problem: Overshoot too long

Solution: Increase I-fraction (CS.01)

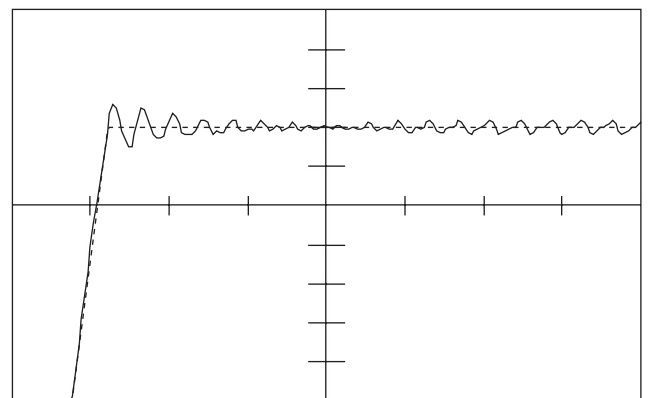

Problem: Sustained oscillation with high amplitude

Solution: Reduce I-fraction (CS.01)

1. Introduction

2. Summary

3. Hardware

4. Operation

5. Parameter

6. Functions

7. Start-up

8. Special Operation

Is currently updated and
will soon be available on
Internet <http://www.keb.de>

9. Error Assistance

10. Project Planning

11. Networks

12. Applications

13. Annex

8. Special Operation

Chapter	Section	Page	Date	Name: Basis	©	KEB Antriebstechnik, 2002 All Rights reserved
8	1	2	18.12.02	KEB COMBIVERT F4-F		

- 1. Introduction
- 2. Summary
- 3. Hardware
- 4. Operation
- 5. Parameter
- 6. Functions
- 7. Start-up
- 8. Special Operation
- 9. Error Assistance**
- 10. Project Planning
- 11. Networks
- 12. Applications
- 13. Annex

- 9.1 Troubleshooting**

- 9.1.1 General 3
- 9.1.2 Error Messages and their Cause 3

Chapter 9	Section 1	Page 2	Date 15.10.02	Name: Basis KEB COMBIVERT F4-F	© KEB Antriebstechnik, 2002 All Rights reserved
---------------------	---------------------	------------------	------------------	--	--

9. Error Assistance

The following chapter shall help you to avoid errors as well as help you to determine and remove the cause of errors on your own.

9.1 Troubleshooting

9.1.1 General

If error messages or malfunctions occur repeatedly during operation, the first thing to do is to pinpoint the exact error. To do that go through the following checklist:

- Is the error reproducible ?

For that reset the error and try to repeat it under the same conditions. If the error can be reproduced, the next step is to find out during which operating phase the error occurs.

- Does the error occur during a certain operating phase (e.g. always during acceleration)?

If so, consult the error messages and remove the causes listed there.

- Does the error occur or disappear after a certain time?

That may be an indication for thermal causes. Check, whether the inverter is used in accordance to the ambient conditions and that no moisture condensation takes place.

9.1.2 Error Messages and their Cause

Error messages are always represented by an $\tilde{N}E\tilde{}$ and the corresponding error in the display of KEB COMBIVERT. In the following the displayed indications and their causes are described.

E. OP	Error! Overvoltage	1	<p>Voltage in the DC-link circuit too high. Occurs if the DC-link circuit voltage exceeds the permissible value. Causes:</p> <ul style="list-style-type: none"> •poor controller adjustment (overshooting) •input voltage too high •interference voltages at the input •deceleration ramp too short •braking resistor defective or too small
E. UP	ERROR underpotential	2	<p>Error: Undervoltage (DC-link circuit). Occurs, if DC-link voltage falls below the permissible value. Causes:</p> <ul style="list-style-type: none"> •input voltage too low or instable •inverter rating too small •voltage losses through wrong cabling •the supply voltage through generator / transformer breaks down at very short ramps • At F5-G housing B E.UP is also displayed if no communication takes place between power circuit and control card. • Jump factor (Pn.56) too small • if a digital input was programmed as external error input with error message E.UP.

E. OC	ERROR overcurrent	4	<p>Error: Overcurrent</p> <p>Occurs, if the specified peak current is exceeded. Causes:</p> <ul style="list-style-type: none"> Å acceleration ramps too short Å the load is too big at turned off acceleration stop and turned off constant current limit Å short-circuit at the output Å ground fault Å deceleration ramp too short Å motor cable too long Å EMC ï DC brake at high ratings active
E. OH	ERROR overheat pow.mod.	8	<p>Error: Overtemperature of power module. Error can only be reset at E.nOH. Causes:</p> <ul style="list-style-type: none"> Å insufficient air flow at the heat sink (soiled) Å ambient temperature too high Å ventilator clogged
E.dOH	ERROR drive overheat	9	<p>Error: Overtemperature of motor PTC. Error can only be reset at E.ndOH, if PTC is again low-resistance. Causes:</p> <ul style="list-style-type: none"> Å resistance at the terminals T1/T2 >1650 Ohm Å motor overloaded Å line breakage to the temperature sensor
E.LSF	ERROR load shunt fault	15	<p>Error: Load-shunt relay has not picked up, occurs for a short time during the switch-on phase, but must automatically be reset immediately. If the error message remains the following causes may be applicable:</p> <ul style="list-style-type: none"> Å load-shunt defective Å input voltage wrong or too low Å high losses in the supply cable Å braking resistor wrongly connected or damaged Å braking module defective
E. OL	ERROR overload (lxt)	16	<p>Error: Overload error can only be reset at E.nOL, if OL-counter reaches 0% again.</p> <p>Occurs, if an excessive load is applied longer than for the permissible time (see technical data). Causes:</p> <ul style="list-style-type: none"> Å poor control adjustment (overshooting) Å mechanical fault or overload in the application Å inverter not correctly dimensioned Å motor wrongly wired Å encoder damaged
E.nOL	no ERROR overload	17	<p>No more overload, OL-counter has reached 0%; after the error E. OL a cooling phase must elapse. This message appears upon completion of the cooling phase. The error can be reset. The inverter must remain switched on during the cooling phase.</p>
E.buS	ERROR bus	18	<p>Error: Adjusted monitoring time (Watchdog) of communication between operator and PC / operator and inverter has been exceeded.</p>
E.OH2	ERROR motor protection	30	<p>Electronic motor protective relay has tripped.</p>

E. EF	ERROR external fault	31	Error: External error. Is triggered, if a digital input is being programmed as external error input and trips.
E.EnC	Error! Encoder	32	Cable breakage of encoder at encoder interface Encoder temperature is too high Speed is too high Encoder signals are out of specification Encoder has an internal error
E.nOH	no E. over heat pow.mod.	36	Temperature of the heat sink is again in the permissible operating range. The error can be reset now.
E.SET	ERROR set	39	It has been attempted to select a locked parameter set. Programmed response îError, restart after resetî.
E.PrF	ERROR prot. rot. for.	46	The drive has driven onto the right limit switch. Programmed response îError, restart after resetî (see chapter 6.7 îResponse to errors or warning messagesî).
E.Prr	ERROR prot. rot. rev.	47	The drive has driven onto the left limit switch. Programmed response îError, restart after resetî.
E.Puc	ERROR pow. unit code	49	Error: During the initialization the power circuit could not be recognized or was identified as invalid.
E.Hyb	ERROR hybrid	52	Invalid encoder interface identifier
E.OL2	ERROR overload 2	53	Occurs if the standstill constant current is exceeded (see technical data and overload characteristics). The error can only be reset if the cooling time has elapsed and E.nOL2 is displayed.
E.OS	ERROR over speed	105	Real speed is bigger than the max. Output speed.
E.SLF	ERROR! Software limit switch forward	111	The right software limit switch lies outside the defined limits. Programmed response îError, restart after resetî.
E.SLr	ERROR software limit switch reverse	112	The left software limit switch lies outside the defined limits. Programmed response îError, restart after resetî.

- 1. Introduction
- 2. Summary
- 3. Hardware
- 4. Operation
- 5. Parameter
- 6. Functions
- 7. Start-up
- 8. Special Operation
- 9. Error Assistance
- 10. Project Planning**
- 11. Networks
- 12. Applications
- 13. Annex

- 10.1 General Design**
- 10.2 Drive Design

- 10.1.1 Control Cabinet Design
Calculation 3
- 10.1.2 Design of Braking Resistors .. 4

10. Project Planning

The following chapter shall assist you in the planning stage of applications.

10.1 General Design

10.1.1 Control Cabinet Design Calculation

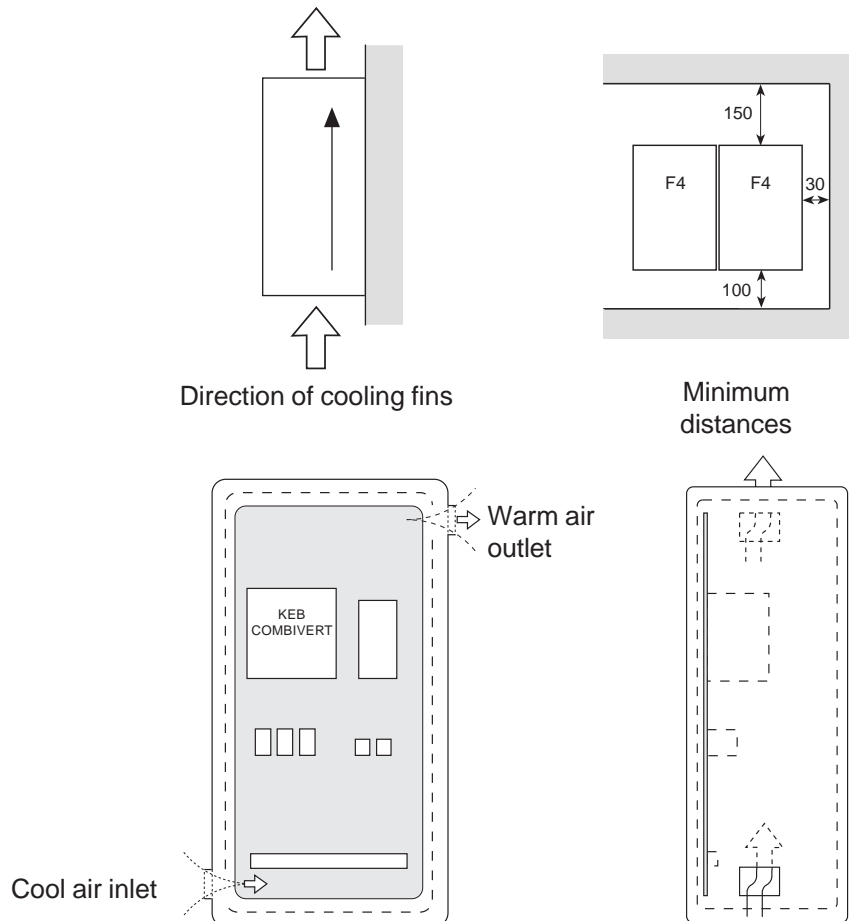

Control cabinet surface

Calculation of control cabinet surface:

$$A = \frac{P_v}{\Delta T \cdot K} \text{ [m}^2\text{]}$$

- A = control cabinet surface [m²]
- ΔT = temperature differential [K]
(standard value= 20 K)
- K = coefficient of heat transmission [$\frac{W}{m^2 \cdot K}$]
(standard value = $5 \frac{W}{m^2 \cdot K}$)

- P_v = power loss (see Technical Data)
- V = air flow rate of fan

Air flow rate with fan cooling :

$$V = \frac{3,1 \cdot P_v}{\Delta T} \text{ [m}^3\text{/h]}$$

For more details please refer to the catalogs of the control cabinet manufacturers.

10.1.2 Design of Braking Resistors

The COMBIVERT fitted with an external braking resistor or an external braking option is suitable for a limited 4-quadrant operation. The braking energy, fed into the DC-bus at generative operation, is dissipated over the braking transistor to the braking resistor. The braking resistor heats up during the braking process. If it is installed in a control cabinet sufficient cooling of the control cabinet interior and sufficient distance to the KEB COMBIVERT must be observed.

Different braking resistors are available for the KEB COMBIVERT. Please refer to the next page for the corresponding formula and restrictions (valid range)

1. Preset desired braking time.
2. Calculate braking time without braking resistor (t_{Bmin}).
3. If the desired braking time shall be smaller than the calculated time, it is necessary to use a braking resistor. ($t_B < t_{Bmin}$)
4. Calculate braking torque (M_B). Take the load torque into account at the calculation.
5. Calculate peak braking power (P_B). The peak braking power must always be calculated for the worst case (n_{max} to standstill).
6. Selection of braking resistor:
 - a) $P_R \geq P_B$
 - b) P_N is to be selected according to the cycle time (c.d.f.).
The braking resistors may be used only for the listed unit sizes. The maximum cyclic duration of a braking resistor shall not be exceeded.

6 % c.d.f. = maximum braking time 8 s
25 % c.d.f.=maximum braking time 30 s
40 % c.d.f. = maximum braking time 48 s

For longer cyclic duration times special designed braking resistors are necessary. The continuous output of the braking transistor must be taken into consideration.

7. Check, whether the desired braking time is attained with the braking resistor (t_{Bmin}).

Restriction: Under consideration of the rating of the braking resistor and the brake power of the motor, the braking torque may not exceed 1.5times of the rating torque of the motor.

When utilizing the maximum possible braking torque the frequency inverter must be dimensioned for the higher current.

Braking time *DEC*

The braking time *DEC* is adjusted at the frequency inverter. If it is chosen too small the KEB COMBIVERT switches off automatically and the error message *OP* or *OC* appears. The approximate braking time can be determined according to following formulae.

Formula

1. Braking time without braking resistor

$$t_{Bmin} = \frac{(J_M + J_L) \cdot (n_1 - n_2)}{9,55 \cdot (K \cdot M_N + M_L)}$$

Valid range: $n_1 > n_N$

(Field weakening range)

2. Braking torque (necessary)

$$M_B = \frac{(J_M + J_L) \cdot (n_1 - n_2)}{9,55 \cdot t_B} - M_L$$

Condition: $M_B \leq 1,5 \cdot M_N$

$f \leq 70 \text{ Hz}$

3. Peak braking power

$$P_B = \frac{M_B \cdot n_1}{9,55}$$

Condition: $P_B \leq P_R$

4. Braking time with braking resistor

$$t_{Bmin}^* = \frac{(J_M + J_L) \cdot (n_1 - n_2)}{9,55 \cdot (K \cdot M_N + M_L + \frac{P_R \cdot 9,55}{(n_1 - n_2)})}$$

Valid range: $n_1 > n_N$

Condition: $\frac{P_R \cdot 9,55}{(n_1 - n_2)} \leq M_N \cdot (1,5 - K)$

$f \leq 70 \text{ Hz}$

$P_B \leq P_R$

K = 0,25 for motors up to	1,5 kW
0,20 for motors	2,2 to 4 kW
0,15 for motors	5,5 to 11 kW
0,08 for motors	15 to 45 kW
0,05 for motors	55 to 75 kW

J_M	= mass moment of inertia motor	[kgm ²]
J_L	= mass moment of inertia load	[kgm ²]
n_1	= motor speed prior to deceleration	[min ⁻¹]
n_2	= motor speed after deceleration (standstill= 0 min ⁻¹)	[min ⁻¹]
n_N	= rated motor speed	[min ⁻¹]
M_N	= rated motor torque	[Nm]
M_B	= braking torque (necessary)	[Nm]
M_L	= load torque	[Nm]
t_B	= braking time (necessary)	[s]
t_{Bmin}	= minimum braking time	[s]
t_z	= cycle time	[s]
P_B	= peak braking power	[W]
P_R	= peak power of braking resistor	[W]

Cyclic duration factor (cdf)

Cyclic duration factor for cycle time $t_z \leq 120 \text{ s}$ Cyclic duration factor for cycle time $t_z > 120 \text{ s}$

$$cdf = \frac{t_B}{t_z} \cdot 100 \%$$

$$cdf = \frac{t_B}{120 \text{ s}} \cdot 100 \%$$

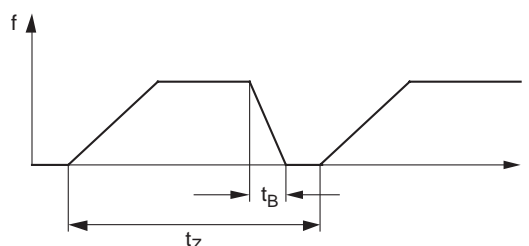

1. Introduction

2. Summary

3. Hardware

4. Operation

5. Parameter

6. Functions

7. Start-up

8. Special Operation

9. Error Assistance

10. Project Planning

11. Networks

12. Applications

13. Annex

10.1 General Design

10.2 Drive Design

Is currently completed and will be available shortly on INTERNET <http://www.keb.de>

Chapter 10	Section 2	Page 2	Date 18.12.02	Name: Basis KEB COMBIVERT F4-F	© KEB Antriebstechnik, 2002 All Rights reserved
----------------------	---------------------	------------------	------------------	--	--

- 1. Introduction
- 2. Summary
- 3. Hardware
- 4. Operation
- 5. Parameter
- 6. Functions
- 7. Start-up
- 8. Special Operation
- 9. Error Assistance
- 10. Project Planning
- 11. Networks**
- 12. Applications
- 13. Annex

- 11.1 Network Components**
- 11.2 Bus-Parameter**

- 11.1.1 Available Hardware 3
- 11.1.2 RS232-Cable PC/Inverter 3
- 11.1.3 Interface- and BUS-Operator . 4
- 11.1.4 Optical Fibre BUS 5
- 11.1.5 InterBus Loop-Operator 9

Chapter 11	Section 1	Page 2	Date 05.01.99	Name: Basis KEB COMBIVERT F4-F	© KEB Antriebstechnik, 1998 All Rights reserved
----------------------	---------------------	------------------	------------------	--	--

11. Networks

The KEB COMBIVERT F4 can be easily integrated into different networks. For that the inverter is fitted with an operator or interface that corresponds to the bus system. Following hardware components are available:

11.1 Network Components

11.1.1 Available Hardware

– RS232-Cable PC/Inverter	Part No.:	00.58.025-000D
– Interface Operator serial network in RS232 or RS485-Standard	Part No.:	00.F4.010-1009
– Bus Operator serial network in RS485-Standard	Part No.:	00.F4.010-7009
– InterBus Loop-Operator	Part No.:	00.F4.010-8019
– InterBus Remote Bus Interface (external)	Part No.:	00.B0.0BK-K001
– LON-Bus-Operator	Part No.:	00.F4.010-4009
– CAN-Bus-Operator	Part No.:	00.F4-010-5009
– Profibus-DP-Operator	Part No.:	00.F4.010-6018
– Optical fibre interface (Master)	Part No.:	00.F4.028-1009
– Optical fibre interface (Slave)	Part No.:	00.F4.028-1008
– Optical fibre operator	Part No.:	00.F4.010-A009

11.1.2 RS232-Cable PC/ Inverter

The 3m-long cable serves for the direct RS232 connection of PC (9-poles or 25-poles SUB-D connector) and inverter.

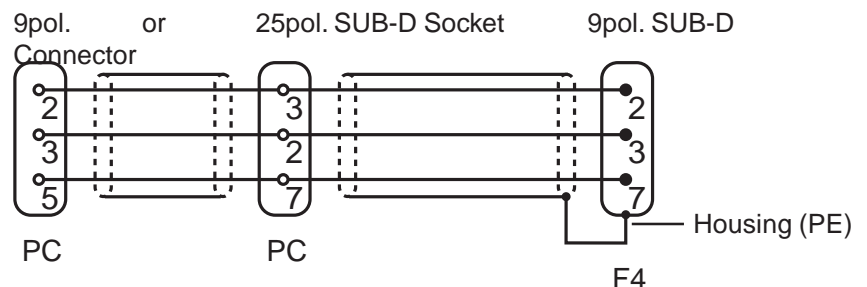

11.1.3 Interface- and Bus-Operator

Integrated into the Interface Operator (00.F4.010-1009) is an isolated RS232/RS485 interface. The RS232-interface is not applicable for the Bus-Operator (00.F4.010-7009). The telegram structure is compatible to protocol DIN 66019 and ANSI X3.28, sub category 2.5, A2, A4 and ISO 1745.

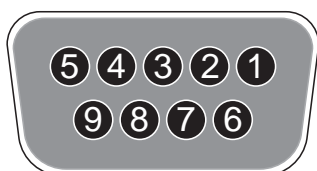
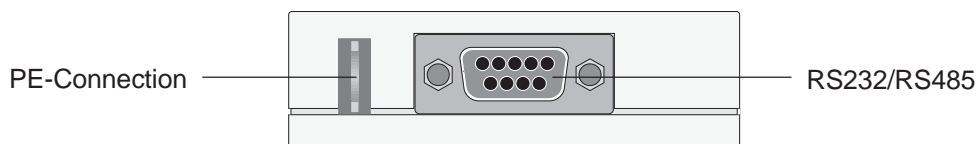

PIN	RS485	Signal	Significance
1	–	–	reserved
2	–	TxD	transmitter signal /RS232
3	–	RxD	receive signal /RS232
4	A'	RxD-A	receive signal A/RS485
5	B'	RxD-B	receive signal B/RS485
6	–	VP	supply voltage -Plus +5V ($I_{max}=10mA$)
7	C/C'	DGND	data reference potential
8	A	TxD-A	transmitter signal A/RS485
9	B	TxD-B	transmitter signal B/RS485

11.1.4 Optical Fibre BUS

For the increasing automation and the thus connected rising number of interference sources the optical fibre represents an important part of the data transmission, since the optical fibre bus is insensitive to electromagnetic interferences.

The optical fibre interface is the link between the electric and the optical transmission.

The serial RS232-interface serves for the connection to data transmission equipment (e.g. PC, PLC). The data terminal equipment (e.g. frequency inverter with optical fibre-operator) are connected to the interface in ring-topology. For that all users (max. 239) must be active.

Components Following components belong to the optical fibre system:

- | | | |
|----|----------------------------------|--------------------------|
| 1. | Optical fibre interface (Master) | Part-No.: 00.F4.028-1009 |
| 2. | Optical fibre interface (Slave) | Part-No.: 00.F4.028-1008 |
| 3. | Optical fibre operator | Part-No.: 00.F4.010-0079 |
| 4. | RS 232 - cable | Part-No.: 00.58.025-000D |

Advantage

- Noise-immune data transfer
- Simple connection
- Electrical isolation
- High transfer rates
- Simple BUS design

Disadvantages

- To get a BUS communication, all users must be active.

**Description
Optical Fibre Interface**

Pin assignment 9-pole SUB-D socket (Master)		
PIN	Signal	Significance
1	-	free
2	TxD	transmitter signal / RS232
3	RxD	receive signal / RS232
4	-	free
5	DGND	data reference potential
6	-	free
7	-	free
8	-	free
9	-	free

Pin assignment 9-pole SUB-D connector (Slave)		
PIN	Signal	Significance
1	-	free
2	TxD	transmitter signal / RS232
3	RxD	receive signal / RS232
4	-	free
5	-	free
6	-	free
7	DGND	data reference potential
8	-	free
9	-	free

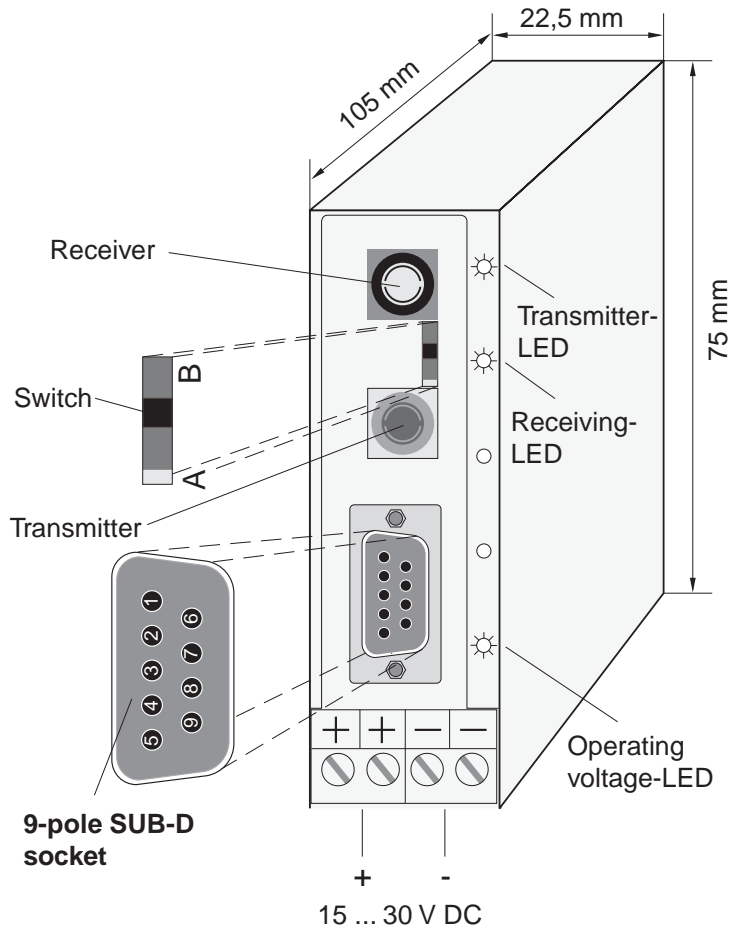

The difference between LWL-Interface Master and Slave is as follows:
The Master has a 9-pole SUB-D socket and the Slave a 9-pole SUB-D connector. It must be taken into consideration that the PIN's of the connector must be assigned in the opposite of the socket in mirror position.

The housing is on all common DIN EN mounting rails mountable.

**Description
Optical Fibre Operator**

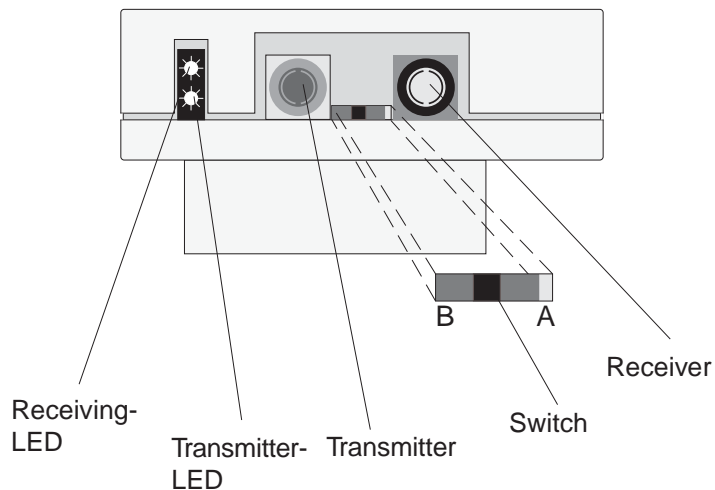

Connection Optical Fibre BUS

Number of users = 1 ... 239

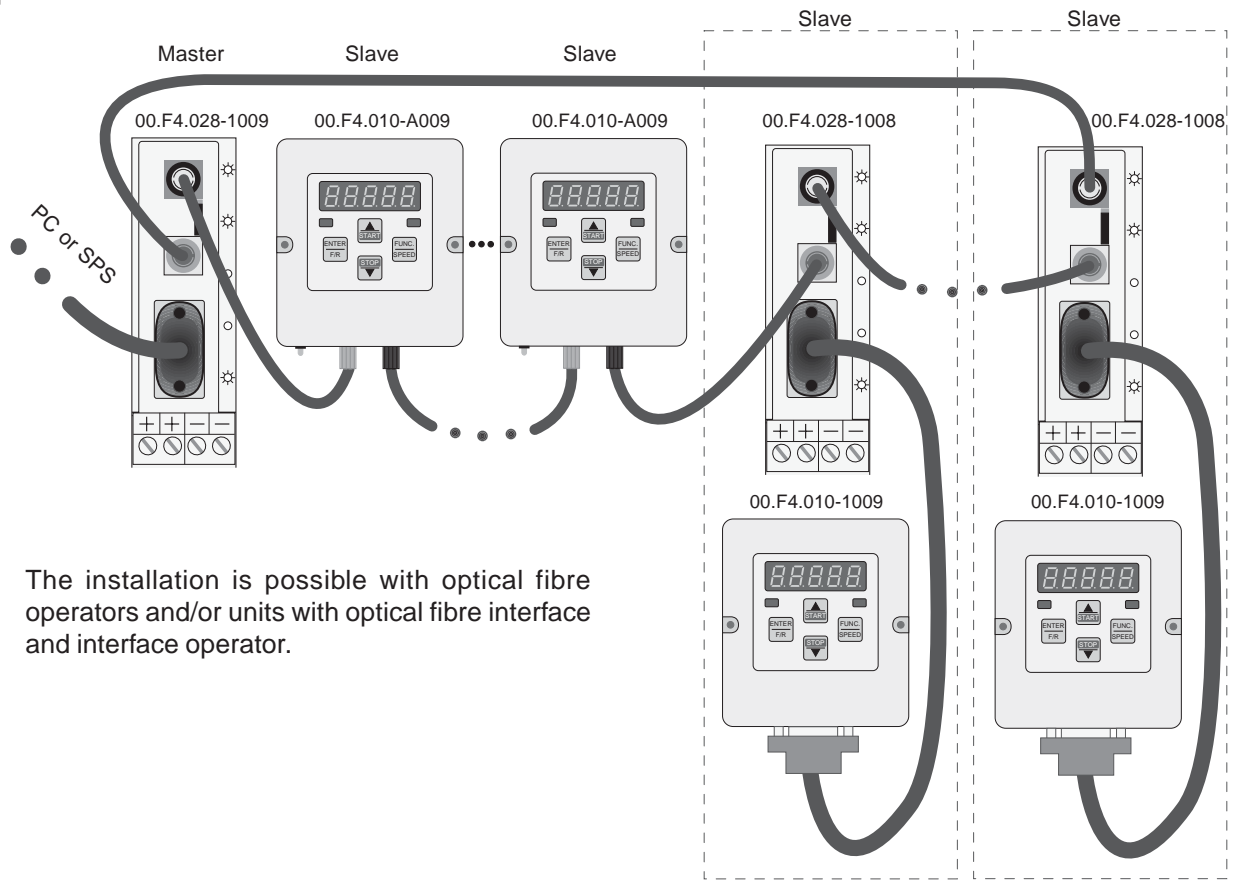

The installation is possible with optical fibre operators and/or units with optical fibre interface and interface operator.

Connection of Optical Fibre Interface to PC (or Master)

9-pole Sub-D Socket

9-pole Sub-D Connector

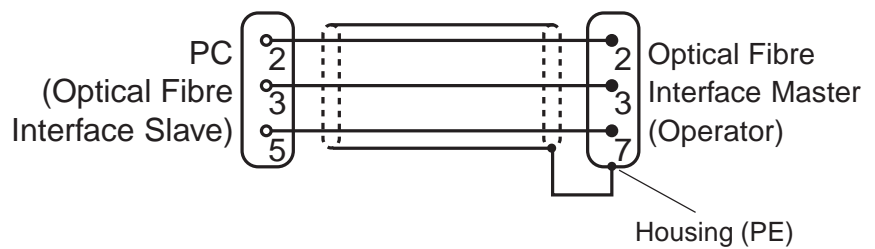

Permissible Line Length between the Users

Cable damping	Switch position A	Switch position B
0,3 dB	0 ... 42 m	3 ... 55 m
0,2 dB	0 ... 63 m	3 ... 83 m
0,1 dB	0 ... 127 m	6 ... 167 m

Tested transfer rate ⇒ 115 kBaud



Switch position A must be used for an ambient temperature > 35 °C.

Chapter 11	Section 1	Page 8	Date 18.12.02	Name: Option 00.F4.Z1A-KB15	© KEB Antriebstechnik, 2002 All Rights reserved
----------------------	---------------------	------------------	------------------	---------------------------------------	--

11.1.5 InterBus Loop-Operator

The InterBus loop-operator is incorporated in a slip-on housing and is connected to a IB-loop stub. InterBus (IB) and loop are specifications of the company Phoenix Contact, Blomberg. The voltage supply is done over the loop from the series-connected loop-bus terminal via a 2-wire, twisted cable together with the modulated data signals. The isolation to the inverter is realized with optocouplers. The switching off of the inverter has no effect on the IBS cycle.

After switching on the loop-operating voltage the inverter is adjusted to the fastest possible transmission rate via the internal, serial KEB-DIN66019 protocol. For that the application password (ud.01=440) as well as the baud rate (ud.07) and the inverter address (ud.06=1) are automatically adjusted.

Picture 11.1.2 InterBus Loop-Operator

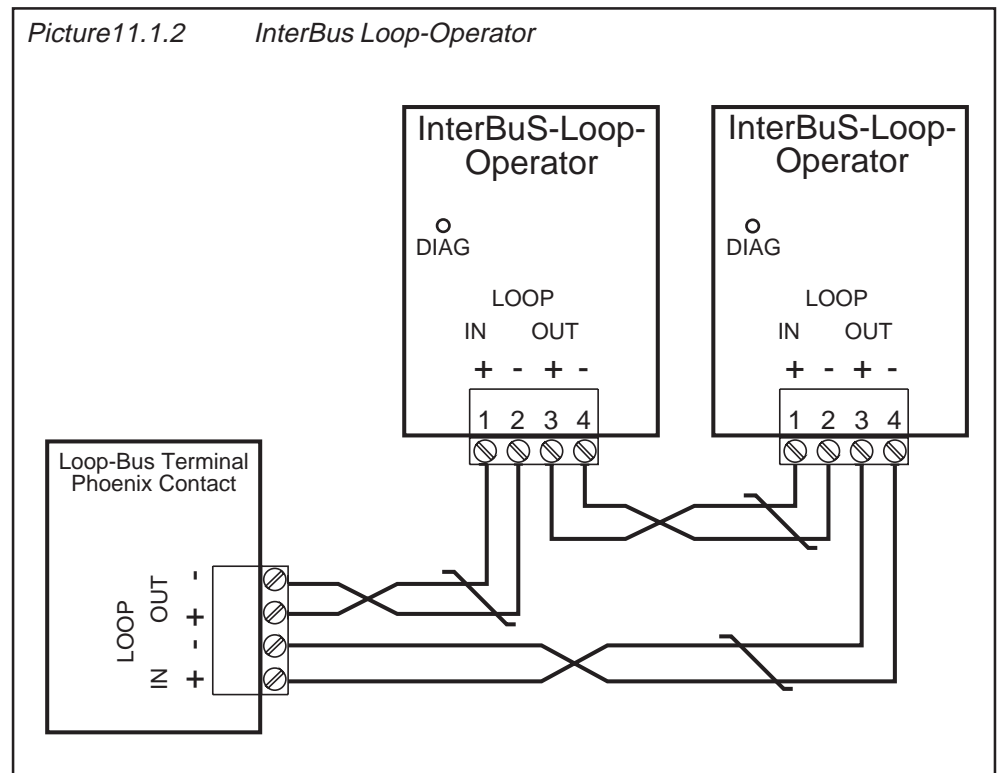

The connection of the operator to the loop is done by means of twisted, unshielded loop-cables (Phoenix Contact) according to following scheme:

- terminal 1 Loop In +
- terminal 2 Loop In -
- terminal 3 Loop Out +
- terminal 4 Loop Out -

The last user is again connected with the loop-in interface of the bus terminal (Phoenix Contact). Of course, other loop-users like digital I/O modules etc. can be connected, too. In each case the polarity as well as the data direction IN / OUT must be observed.

Chapter 11	Section 1	Page 10	Date 05.01.99	Name: Basis KEB COMBIVERT F4-F	© KEB Antriebstechnik, 1998 All Rights reserved
----------------------	---------------------	-------------------	------------------	--	--

- 1. Introduction
- 2. Summary
- 3. Hardware
- 4. Operation
- 5. Parameter
- 6. Functions
- 7. Start-up
- 8. Special Operation
- 9. Error Assistance
- 10. Project Planning
- 11. Networks**
- 12. Applikations
- 13. Annex

- 11.1 Network Components
- 11.2 Bus-Parameter**

- 11.2.1 Adjustment of Inverter
Address 3
- 11.2.2 Baud Rate 3
- 11.2.3 Used parameter 4

Chapter 11	Section 2	Page 2	Date 06.11.02	Name:Basis KEB COMBIVERT F4-F	© KEB Antriebstechnik, 2002 All Rights reserved
----------------------	---------------------	------------------	------------------	---	--

11.2. Bus-/ DRIVECOM- Parameter

11.2.1 Adjustment of Inverter Address (ud.6)

With ud.6 the address is adjusted under which the inverter responds to „COMBIVIS“ or other controls. Values between 0 and 239 are possible, the standard value is 1. If several inverters are operated simultaneously on the bus, it becomes absolutely necessary to give each one a different address, otherwise it can result in faulty communication, since it is possible that several inverters respond. Further information is contained in the description of DIN66019-protocol.

11.2.2 Baud Rate (ud.7)









Following values are possible for the baud rate of the serial interface:

Parameter value	Baud rate
0	1200 baud
1	2400 baud
2	4800 baud
3	9600 baud
4	19200 baud
5	38400 baud
6	57600 baud

If the value for the baud rate is changed over the serial interface it can be changed again only by keyboard or after adaption of the baud rate of the master, since different baud rates of master and slave do not allow a communication.

The baud rates 5 (38400 baud) and 6 (57600 baud) are not available on all units. The function of these transfer rates cannot be guaranteed for all ambient conditions. Should problems occur with the data transmission select a transfer rate of max. 19200 baud.

11.2.3 Used parameter

Param.	Adr.	 R/W	 PROG.	 ENTER	 min	 max	 Step	 default	
ud.6	2606h	✓	-	✓	0	239	1	1	-
ud.7	2607h	✓	-	✓	0	6	1	3	= 1200 to 57600 Baud
ud.8	2608h	✓	-	✓	0 s	10,00 s	0,01s	0: off	-

1. Introduction
2. Summary
3. Hardware
4. Operation
5. Parameter
6. Functions
7. Start-up
8. Special Operation
9. Error Assistance
10. Project Planning
11. Networks
- 12. Applications**
13. Annex

Here solved applications are filed which can be retrieved from the INTERNET <http://www.keb.de>.

12. Applications

Chapter	Section	Page	Date	Name: Basis	©	KEB Antriebstechnik, 2002 All Rights reserved
12	1	2	18.12.02	KEB COMBIVERT F4-F		

1. Introduction

2. Summary

3. Hardware

4. Operation

5. Parameter

6. Functions

7. Start-up

8. Special Operation

9. Error Assistance

10. Project Planning

11. Networks

12. Applications

13. Annex

13.1 Search and Find

13.1.1	Index	3
13.1.2	Term Definition	10
13.1.3	KEB - Worldwide	12
13.1.4	Domestic Representations	14
13.1.5	Notes	15

Chapter 13	Section 1	Page 2	Date 18.12.02	Name: Basis KEB COMBIVERT F4-F	© KEB Antriebstechnik, 2002 All Rights reserved
----------------------	---------------------	------------------	------------------	--	--

13. Annex

13.1 Search and Find

13.1.1 Index

Symbols

230V-Class 2.1.6
400V-Class 2.1.7, 2.1.8

A

AA. 0... 6 6.8.7
AA. 7...13 6.8.8
Abnormal Stopping 4.3.6
Acceleration time 4.3.7, 6.11.10
Active
 current 6.1.9
 parameter set 6.1.12
Actual
 load 6.1.9
 position 6.1.14
 speed
 display 4.3.5, 6.1.8
 master 6.1.13
 torque display 4.3.7, 6.1.8
Adaption factor 6.5.14
Adjustment
 assistant 6.8.7
 possibilities 4.4.3
An. 1 6.2.6
An. 2 6.2.9
An. 3... 5 6.2.6
An. 8 6.2.9
An. 9...11 6.2.6
An.12 6.2.3
An.13 6.4.5, 6.4.9, 6.8.9
An.15 6.2.11
An.16 6.2.11
An.19 6.2.11
An.20 6.2.11
Analog
 inputs 6.2.3
 outputs 6.2.3, 6.2.10
 setpoints 6.4.5
Angular
 correction 6.10.11
 difference
 resetting 6.10.6
 deviation 6.1.13
Apparent
 current 6.1.9

motor current 4.3.6
Application 4.2.3
 mode 4.1.3
 time 6.8.3
Automatic restart 6.6.5
AUX-Function 4.3.22, 6.4.4,
6.4.5, 6.4.9, 6.8.9

B

Baud rate 11.2.3
bbl 4.3.6
Binary-coded
 set selection 6.7.5
Boost 4.3.4, 4.3.20, 6.5.6
Brake control 6.8.3
 examples 6.8.4
Braking
 resistors 10.1.4
 time DEC 10.1.5
 torque 10.1.4, 10.1.5
 emergency stop 6.6.7
Bus
 error 9.1.4
 operator 11.1.4

C

c.d.f. 10.1.4
Cable damping 11.1.7
CAN-Bus 11.1.3
 operator 11.1.3
Change encoder
 rotation 4.3.21
Clock frequency
 encoder 1 6.9.6
 encoder 2 6.9.9
Code
 encoder 2 6.9.9
Config-file-number 6.1.17
Control
 cabinet 10.1.3
 card defect 9.1.5
 terminal strip 3.1.5
 units 3.1.3
Controller
 activation 6.5.5
 adjustment 6.5.3
 structure 6.5.9
Coolant

warning 6.8.13
Corner speed 6.5.11
CP
 mode 4.3.3
 on 4.2.3
 parameter 4.3.3
 assignment 6.12.4
 definition 6.12.3
 read only 4.2.3
 service 4.2.3
CP. 0 4.3.5
CP. 1 4.3.5
CP. 2...4 4.3.6
CP. 5...7 4.3.7
CP. 8...9 4.3.8
CP.10...11 4.3.10
CP.12...14 4.3.11
CP.15 4.3.12
CP.16 4.3.13
CP.17 4.3.14
CP.18 4.3.15
CP.19...21 4.3.16
CP.22 4.3.17
CP.23...28 4.3.18
CP.29...31 4.3.19
CP.30...31 4.3.19
CP.32...33 4.3.20
CP.34...35 4.3.21
CP.36 4.3.22
CPU-error 9.1.5
CS-parameter 6.5.5
CS. 0 6.5.10
CS. 1 6.5.10
CS. 3 6.5.10
CS. 4 6.5.10
CS. 6... 9 6.5.11
CS.10 6.5.14
CS.11...14 6.5.10
CS.19...21 6.5.11
CS.22 6.5.13
CS.23 6.5.5
CS.39 6.5.13
CS.40 6.5.13
Current Control 6.5.10, 4.3.17
Customer
 mode 4.1.3
 number 6.1.17
Cyclic duration factor (cdf) 10.1.5

D

DC-link voltage 6.1.9

peak value	6.1.10	dS.12...14	6.5.8	track change	6.9.9
Deceleration Time	4.3.8	dS.15...17	6.5.18	ENTER	
Delay time	6.8.3	dS.18	6.5.16	parameter	4.1.4
Delta connection	6.5.3	Dummy cap	7.1.3	Error	
di. 0	6.3.5			assistance	9.1.3
di. 1	6.3.3	E		brake	9.1.5
di. 2	6.3.5	E. EF	9.1.4	counter	6.1.18
di. 3... 12	6.3.7	reaction	6.6.6	messages	9.1.3
di.15	6.3.4	E. OC	9.1.3	External	
di.16	6.3.4	E. OH	9.1.4	error control procedure	6.6.6
di.17...19	6.3.5	reaction	6.6.3	fault	9.1.5
Digital		E. OL	9.1.4	F	
filter	6.3.5	E. OP	9.1.3	F.Acc	4.3.6
inputs	3.1.6, 6.3.3	E. UP	9.1.3	F.con	4.3.6
diagram	6.3.3	E.buS	9.1.4	F.dEc	4.3.6
set by Software	6.3.4	E.dOH	9.1.4	Factory setting	4.3.3, 4.3.23
outputs	6.3.9	reaction	6.6.3	Features of F4-F	2.1.3
diagram	6.3.9	Switch-off Delay	6.6.3	Field weakening	6.5.12
rotation		E.hyb	9.1.5	Filter mode	
setting	6.4.6	E.LSF	9.1.4	adjustment	6.3.13
setpoints	6.4.5	E.nOH	9.1.4	Flow	
DIN 66019	11.1.9	E.nOL	9.1.4	controller mode	6.5.13
Display	4.4.3	E.OL	6.1.12	Flux	
OL-counter	6.1.12	E.OL2	9.1.4	controller	
do. 0	6.3.15	E.PrF	9.1.5	mode	6.5.14
do. 1... 8	6.3.10	E.Prr	9.1.5	lowering	
do. 9...25	6.3.14	E.PuC	9.1.4	calculation	6.5.12
do.26...31	6.3.12	E.SET	9.1.4	Fr. 0	6.7.3, 6.12.3
dr. 0... 4	6.5.3	E.SLF	9.1.5	Fr. 2	6.7.5
dr. 3	6.5.5	E.SLr	9.1.5	Fr. 3	6.7.6
dr. 9	6.5.10	EC.0	6.9.3	Fr. 4	6.7.5
dr.10	6.5.5, 6.5.10	EC.1	6.9.5	Fr. 5	6.7.7
dr.12	6.5.3, 6.5.5	EC.2	6.9.5	Fr. 6	6.7.7
dr.13	6.5.5, 6.5.11	EC.5	6.9.6	Fr. 9	6.7.3, 6.7.4
dr.16	6.5.5, 6.5.11	EC.6	6.9.5	Fr.10	6.5.4, 6.5.14
dr.19	6.5.6, 6.5.12	EC.8	6.9.12	Function	
dr.20	6.5.11	EC.9	6.9.6	assignment	6.3.7
dr.21	6.5.11	EC.10	6.9.3	output A1	4.3.15
dr.48	6.5.17	EC.11	6.9.5	principle	2.1.3
dr.49	6.5.17	EC12	6.9.5	Fundamentals	4.1.3
dr.50	6.5.17	EC.13	6.9.8		
dr.51	6.5.17	EC.14...16	6.9.9	G	
dr.52	6.5.17	EC.18	6.9.12	Gain	
dr.56	6.5.21	EC.20	6.9.6	of input characteristic	6.2.6
Drive-Mode		EC.21	6.9.7	of output characteristic	6.2.11
leaving	4.1.3, 4.2.3, 4.4.3	EMC-conform installation	7.1.3	output A1	4.3.16
dS-parameter	6.5.5	Encoder		output A2	4.3.16
dS. 0...9	6.5.10	interface	6.9.3		
dS.10	6.5.6	power supply	6.9.3		
dS.11	6.5.6	resolution	6.9.9		
		selection	6.9.10		

Password	4.2.4	Power	RS232/485	11.1.3, 11.1.4, 13.1.9
input	4.3.5	Off	ru-parameter	
levels	4.2.3	function	description	6.1.5
structure	4.2.3	mode	summary	6.1.3
Pc. 0	6.11.3	starting voltage	ru. 0	6.1.5, 6.12.4
Pc. 1	6.11.6	unit code	ru. 1	6.1.8, 6.5.5
Pc. 4... 9	6.11.10	Product description	ru. 2	6.1.8, 6.5.5
Pc.10	6.11.17	Profibus-DP	ru. 4	6.1.8, 6.5.5
Pc.11...13	6.11.5	Operator	ru. 7	6.1.9, 6.3.11
Pc.14	6.10.4, 6.11.16	Project planning	ru. 8...10	6.1.9
Pc.16	6.11.4		ru.10	6.5.5
Pc.17	6.11.4	Q	ru.11	6.1.9
Pc.18...19	6.11.14	QS-number	ru.12	6.1.10
Pc.33...34	6.11.15		ru.14	6.1.10, 6.3.4
Pc.35	6.11.16		ru.15	6.1.10, 6.3.15
Pc.36	6.11.15	R	ru.16	6.1.11, 6.3.8
Pd-parameter	6.5.5	r.Acc	ru.17	6.1.11
Pd. 0	6.11.4	r.con	ru.18	6.1.12
Pd. 1	6.11.12, 6.11.17	r.dEc	ru.20	6.1.12
Pd. 2	6.11.10	Ramp	ru.22...24	6.1.12
Pd. 3	6.11.8	adjustment	ru.25...29	6.1.13
Pd. 5... 7	6.11.8	diagram	ru.31	6.1.14
Pd. 8...10	6.11.11	generator	ru.32	6.1.14
Pd.11	6.11.12	acceleration times	ru.35	6.1.14
Pd.12	6.11.20	deceleration times	ru.35...40	6.11.4
Pd.15	6.11.13, 6.11.15, 6.11.21	S-curve time	ru.36	6.1.14
Peak load	6.1.10	Range	ru.37...40	6.1.15
Pn. 0	6.6.7	correcting	ru.58	6.1.16
Pn. 1	6.6.7	Rated	ru.59	6.1.16
Pn. 7	6.6.5, 6.6.8	inverter	ru.60	6.1.16
Pn.16	6.3.10, 6.6.3	current	Run	4.4.4
Pn.17	6.6.5	motor		
Pn.20	6.6.6	cos (Phi)	S	
Pn.23	6.6.6	current	Selection of a parameter	4.1.4
Pn.24	6.6.6	frequency	Serial number	
Pn.25	6.6.3	power	ackn.-no.	6.1.17
Pn.26	6.6.5	speed	counter	6.1.17
Pn.33	6.6.5	voltage	date	6.1.17
Pn.60	6.6.7	Reaction to Limit Switch	Service	4.2.3
Pn.63	6.6.7	REF display	Set	
Position		Reference point	position	6.10.6, 6.11.11
controller	6.10.5	approach	selection error	9.1.4
limit	6.11.10	mode	Setpoint	
values		Register function	addition	6.4.9
adjustment mode	6.11.4	Release time	adjustment	
display mode	6.11.6	Resetting of	diagram	6.4.3
Positioning		error messages	calculation	6.4.8
cancel	6.11.8	peak values	display	4.4.3
module	6.11.3	Rotation	input	4.4.3
activating	6.11.3	selection	limits	6.4.7
mode	6.11.5	setting	selection	6.4.4
			speed	

before ramp	6.1.12	Start-up	230V-Class	2.1.6
display	6.1.8	closed-loop	400V-Class (10-17)	2.1.7
maximum	4.3.10	controlled	400V-Class (18-24)	2.1.8
Sn-parameter	6.5.5	Status display		
Sn. 1...3	6.10.3	Stop		
Sn. 5	6.10.3, 6.10.6	key	V	
Sn. 6	6.10.4	Switching	Voltage	
Sn. 7	6.10.4	conditions	control	
Sn. 8	6.10.10	inverting	max.	6.5.12
Sn. 21	6.10.10	logic operation		
Sn. 22...54	6.10.11	selections	W	
Sn. 55...57	6.10.3	Synchronous control	Watchdog	
Software		Synchronzation	time	6.6.6
date	6.1.17			6.6.6
DSP	6.1.19	T		
identification	6.1.16	Teach function	Z	
DSP	6.1.18	Temperature	Zero point hysteresis	6.2.9
limit		control	REF 1	4.3.14
forward	9.1.5	max.		
reverse	9.1.5	set		
switch	6.11.10	switching time		
SP. 0	6.4.6, 6.8.12	Terminal status		
SP. 1	6.4.5	Thermal inverter protection		
SP. 2	6.4.5	Torque		
SP. 3	6.4.6	control	6.5.10	
SP. 4... 7	6.8.12	level output D1	4.3.18	
SP. 4... 9	6.4.7	limit	4.3.8	
SP.11...14	6.4.10	limitation	6.5.11	
SP.15...18	6.4.12	Trigger		
SP.26	6.8.12	position	6.8.7	
SP.27	6.8.12	source	6.8.7	
Specifications	2.1.6	Trouble shooting	9.1.3	
Speed		Type code	2.1.5	
control	6.5.10			
droop	6.1.13	U		
hysteresis	6.8.3	U/f-characteristic	6.5.6	
key	4.4.3	ud-parameter	6.12.3	
level output	4.3.18	ud. 0	4.4.3, 6.12.3	
reference display	4.3.7	ud. 2	6.12.4	
regulation on/off	4.3.20	ud. 3	6.12.4	
search	6.6.7, 13.1.9	ud. 6	11.2.3	
SSI-Interface	6.9.9	ud. 7	11.2.3	
Stall	13.1.9	ud. 8	11.2.3	
Standard-parameters	4.1.4	ud.15...86	6.12.4	
Star connection	6.5.3	Undervoltage	9.1.3	
Start	4.4.4	Unit Sizes		
key	4.4.3			
up	7.1.3			

Chapter 13	Section 1	Page 8	Date 18.12.02	Name: Basis KEB COMBIVERT F4-F	© KEB Antriebstechnik, 2002 All Rights reserved
----------------------	---------------------	------------------	------------------	--	--

13.1.2 Term Definition

Analog/Digital Earth	The COMBIVERT F4 has isolated digital inputs, i.e. the inputs are galvanically separated from the internal potential. Thus equalizing currents between the components are avoided. The digital earth is the reference point of this separated control circuit. The analog earth is directly connected with the inverter ground, it serves as potential for the analog setpoint setting.
EMC	Electromagnetic compatibility ; the guidelines for the reduction of interferences emitted by units as well as the safety of operation of troubled units.
Energy-saving Function	When motors run at no-load the voltage can be lowered once this state is reached thereby saving energy.
Frequency-dependent Switch	Relay or transistor output which switches dependent of a preadjusted frequency.
Actual value	At a closed-loop controlled system it is the feedback value supplied by the external detection. At controlled systems it is the value calculated on the basis of the adjusted conditions.
LA-Stop	Acceleration stop prevents overcurrent errors during acceleration by stopping the ramp. The current level is determined through the max. ramp current (CP.14).
RS232/485	RS232, standardized serial interface for max. 1 end unit at a max. line length of 15 m. RS485, standardized serial interface for max. 240 end units and 1000 m line lengths.
Setpoint Value	The analog and digital preset values with which the frequency inverter shall operate.
Speed Search	Speed Search prevents overcurrent errors at the connection to rotating motors. The motor speed is indirectly determined, the inverter accelerates only after it has adapted its rotary speed.
Stall	The Stall function protects the inverter from switch off due to overcurrent at constant output frequency. On exceeding the level adjusted with CP.15 the output frequency is reduced until the value is again below the adjusted value.

Chapter	Section	Page	Date	Name: Basis	©	KEB Antriebstechnik, 2002 All Rights reserved
13	1	10	18.12.02	KEB COMBIVERT F4-F		

13.1.3 KEB- Worldwide

		Fax: 0033/1/45767495		Fax: 0046/4079994	
ET	Tarek El Sehelly Import & Export P.o. Box 83 ET-Mehalla El Kobra Tel.: 0020/40243839 Fax: 0020/40235753	GR	ELMO L.T.D. Power Transmission & Engineering GR - 18, Athinon 185 40 Piraeus Tel.: 0030/1/4221992 Fax: 0030/1/4176319	CH	Stamm Industrieprodukte AG Hofstraße 106 CH - 8620 Wetzikon Tel.: 0041/1/9325980 Fax: 0041/1/9325986
RA	Eurotrans S.r.l. Sarmiento 2759 - (1646) San Fernando RA - Pcia. de Buenos Aires Tel.: 0054/11/4744-3366 Fax: 0054/11/4744-3366	IL	OMEGA Engineering Ltd. P.O. Box 1092 IL - 44110 Kfar-Saba Tel.: 00972/9/7673240 Fax: 00972/9/7673398	E	ELION S.A. Farell 9 E - 08014 Barcelona Tel.: 0034/93/2982030 Fax: 0034/93/2965632
B	S.A. Vermeire Belting N.V. Rue de la Filature, 41 B - 4800 Ensival (Verviers) Tel.: 0032/87/322360 Fax: 0032/87/315071	I	KEB Italia S.r.l. Via Newton, 2 I - 20019 Settimo Milanese (Milano) Tel.: 0039/02/33500782 0039/02/33500814 Fax: 0039/02/33500790	RSA	Pneumatic Electric Control Systems (PTY) Ltd. P.O. Box 47396 Stamford Hill RSA - Durban / Greyville 4023 Tel.: 0027/31/3033701 Fax: 0027/31/23-7421
BR	AC Control Comércio e Serviços Rua Angelo Giannini,13-Santa Amaro BR - CEP 04775-130 - Sao Paulo Tel.: 0055/11/55646579 Fax: 0055/11/55646579	J	KEB - YAMAKYU Ltd. 15 - 16, 2 - Chome Takanawa Minato-ku J - Tokyo 108 - 0074 Tel.: 0081/33/445-8515 Fax: 0081/33/445-8215	R.O.C.	URGTEK Co., Ltd. No.19-5, Shi Chou Rd, TounanTown R.O.C. - Yin-Lin Hsian, Taiwan Tel.: 00886/5/597 5343 Fax.: 00886/5/596 8198
RCH	Tecco Andina S.A. Maule 80 RCH-Santiago, Chile Tel.: 0056/2/5550738 Fax: 0056/2/5558445	J	KEB - YAMAKYU Ltd. 711, Fukudayama, Fukuda J - Shinjo-Shi, Yamagata 996 - 0053 Tel.: 0081/233/29-2800 Fax: 0081/233/29-2802	TH	INNOTECH Solution Co. Ltd. 518 Nec Building, 5th Floor Ratchadapisek Road TH - Huaykwang, 10320 Bangkok Tel.: 0066/2/9664927 Fax.: 0066/2/9664928
CHN	Beijing Big Lion Machinery & Electronics Development Co. Dashanzi Dongzhimen Wai CHN - Beijing P.R. Tel.: 0086/10/64368019 Fax: 0086/10/64362011	NZ	Vectek International 21 Carnegie Road, Onekawa NZ - Napier Tel.: 0064/6/8431400 Fax: 0064/6/8430398	TN	H 2 M 13, Rue El Moutanabi TN - 2037, El Menzah 7 Tel.: 00216/1/860808 Fax: 00216/1/861433
DK	REGAL A/S Industrivej 4 DK - 4000 Roskilde Tel.: 0045/4677 7000 Fax: 0045/4675 7620 E-mail: regal@regal.dk	NL	Marsman Elektronica En Aandrijvingen BV Zeearend 16 NL - 7609 PT Almelo Tel.: 0031/546/812121 Fax: 0031/546/810655	TR	TEPEKS Ltd. Sirketi POLAT Plaza B. Blok Kat 5 TR - 80640 Levent, Istanbul Tel.: 0090/212/3252530 Fax.: 0090/212/3252535
GB	KEB (UK) Ltd. 6 Chieftain Business Park Morris Close Park Farm, Wellingborough GB - Northants, NN8 6 XF Tel.: 0044/1933/402220 Fax: 0044/1933/400724	N	VEM Motors Norge AS Skjærvaveien 38 N - 2011 Stroemmen Tel.: 0047/63840910 Fax: 0047/63842230	USA	KEBCO Inc. 1335 Mendota Heights Road USA - Mendota Heights, MN 55120 Tel.: 001/651/4546162 Fax: 001/651/4546198
FIN	Advancetec Oy Malminkaari 10 B PL 149 FIN - 00701 Helsinki Tel.: 00358/9/3505 260 Fax: 00358/9/3505 2600	A	KEB-Antriebstechnik Ges. m.b.H. Ritzstraße 8 H A - 4614 Marchtrenk CZ Tel.: 0043/7243/53586-0 SK Fax: 0043/7243/53586-21		
F	Société Francaise KEB Z.I. de la Croix St. Nicolas 14, rue Gustave Eiffel F - 94510 LA QUEUE EN BRIE Tel.: 0033/1/49620101	P	JOMARCA Ca. Lda Senra Cavaloes P - 4760 V. N Famalicao Tel.: 00351/52/315144 Fax: 00351/52/311430		
		S	REVA - drivteknik AB Slussgatan 13 S - 21130 Malmö Tel.: 0046/4077110		

13.1.4 Domestic Representations

**New
Federal Lands** KEB Antriebstechnik GmbH & Co. KG
Wildbacher Str. 5
08289 Schneeberg
Tel.: 0 37 72 / 67-0
Fax: 0 37 72 / 6 72 81

**New
Federal Lands** Ing. Büro Schumer & Partner
Gottschallstr. 11
04157 Leipzig
Tel.: 03 41 / 9 12 95 11
Fax: 03 41 / 9 12 95 39

**Hamburg
Schleswig-Holstein
Bremen** KEB-Vertriebsbüro Nord
Mr. Haase
Knüll 9a
21698 Bargstedt
PF: 11 12 / PLZ: 21694 Harsefeld
Tel.: 0 41 64 / 62 33
Fax: 0 41 64 / 62 55

NRW East KEB-Antriebstechnik
Vertriebsbüro West
Gartenstraße 18
33775 Versmold
Tel.: 0 54 23 / 94 72-0
Fax: 0 54 23 / 94 72-20

NRW West Ing. Büro für rationale Antriebe
Horst Thomalla GmbH
Vorsterstraße 448
41169 Mönchengladbach
Tel.: 0 21 61 / 55 62 62
Fax: 0 21 61 / 55 78 68

**Hessen
partially
Rheinland-Pfalz** Heinrich Stanlein
Ingenieurbüro GmbH
Am Hasengarten 12
35745 Herborn-Hörbach
Tel.: 0 27 72 / 9 40 50
Fax: 0 27 72 / 5 35 76 + 8 23 46

**Saarland
partially
Rheinland-Pfalz** KEB Vertriebsbüro Süd-West
Mr. Heinert
Kirschsteinanlage 2
55543 Bad Kreuznach
Tel.: 06 71 / 4 67 23
Fax: 06 71 / 4 68 76

Baden-Württ. Laipple / Brinkmann GmbH
Mr. Laipple
Ziegelhau 13
73099 Adelberg
Tel.: 0 71 66 / 9 10 01-0
Fax: 0 71 66 / 9 10 01 26

Bavaria South

KEB-Antriebstechnik
Vertriebsbüro Süd
Wehrstraße 3
84419 Schwindegg
PF: 37 / PLZ: 84417
Tel.: 0 80 82 / 57 32 + 58 37
Fax: 0 80 82 / 57 30

Bavaria North

KEB-Vertriebsbüro Süd-Ost
Ajtoschstr. 14
90459 Nürnberg
Tel.: 0911 / 4 59 62 97
Fax: 0911 / 4 59 62 98

13.1.5 Notes

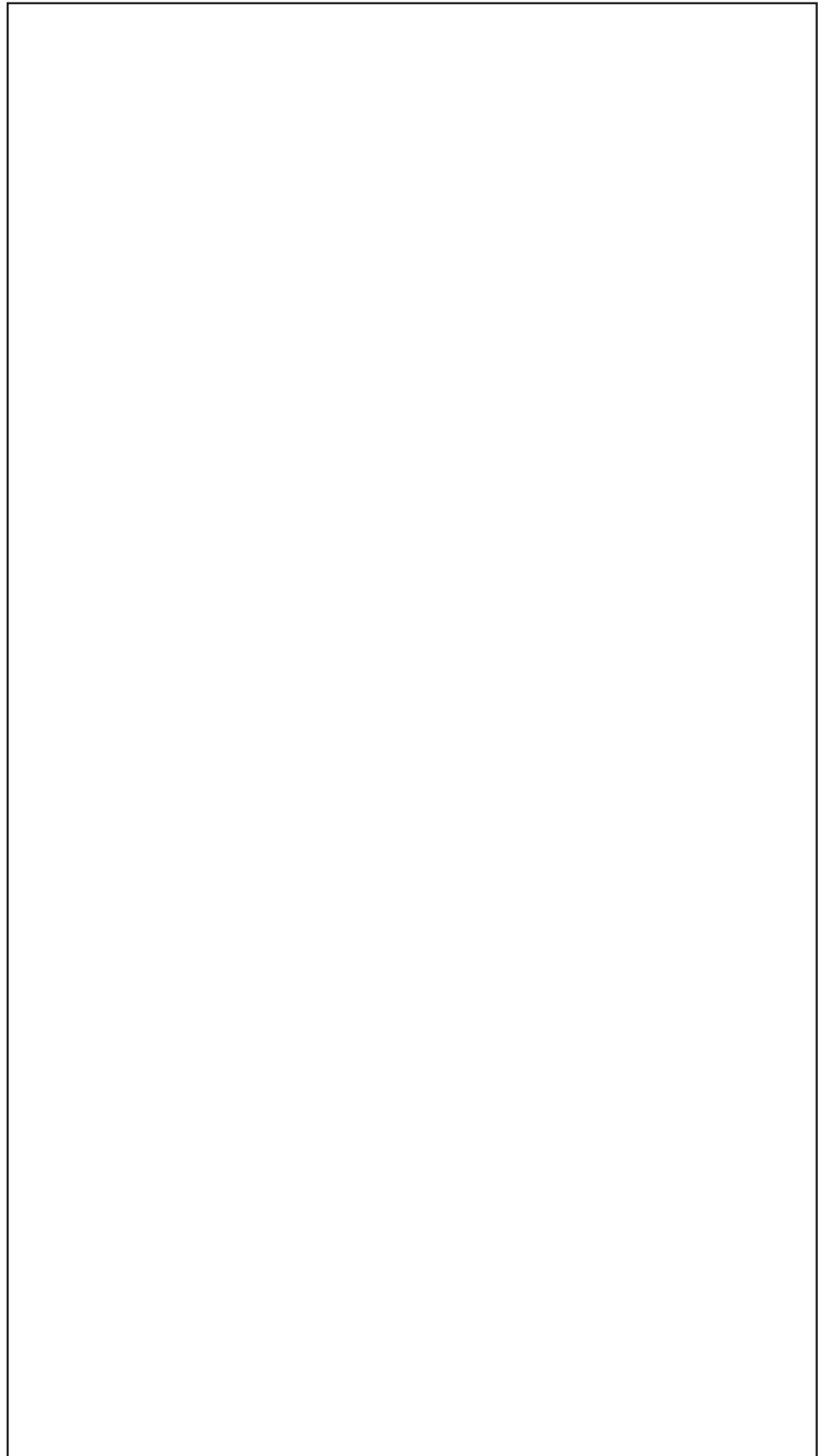

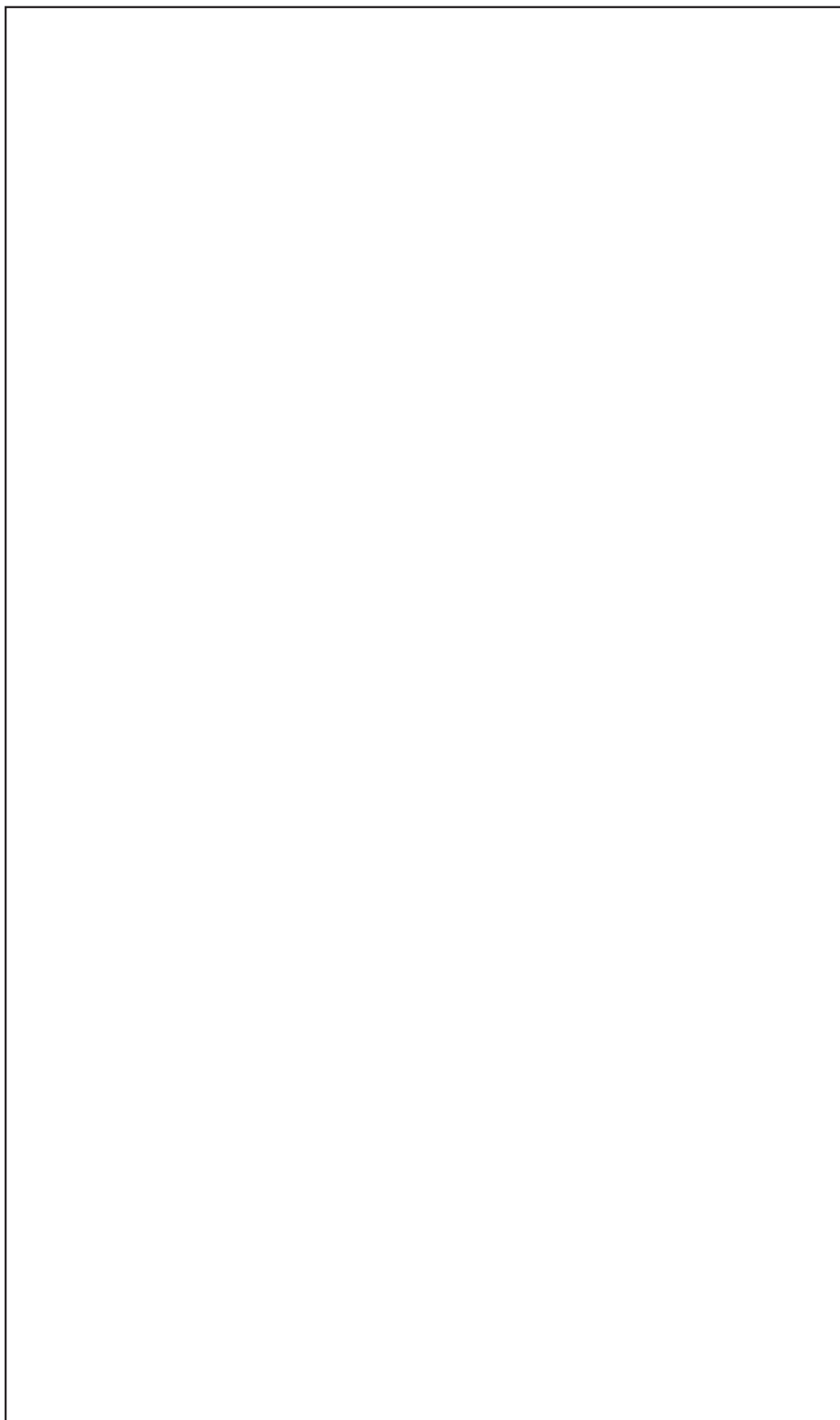



Karl E. Brinkmann GmbH
Försterweg 36 - 38 • D - 32683 Barntrup
Telefon 0 52 63 / 4 01 - 0 • Telefax 4 01 - 116
Internet: www.keb.de • E-mail: info@keb.de